

Fenland District Council Cambridgeshire County Council March Area Transport Study

Traffic Forecasting Report
25 August 2011

ATKINS

Plan Design Enable

Notice

This document and its contents have been prepared and are intended solely for Cambridgeshire County Council's and Fenland District Council's information and use in relation to March Area Transport Study.

Atkins Transport Planning assumes no responsibility to any other party in respect of or arising out of or in connection with this document and/or its contents.

Document History

JOB NUMBER: 5097866			DOCUMENT REF: MATS_TFR_V3.2.Docx			
Revision	Purpose Description	Originated	Checked	Reviewed	Authorised	Date
0.1	Draft for internal review	KT/SA	NP	PE	PE	Apr 11
1.0	Draft – issued to CCC/FDC for comments	KT	NP	PE	PE	Apr 11
2.0	Updated in response to CCC/FDC comments	KT	KT	PE	PE	Jun 11
3.0	Chapter 6 & 7 update (Draft)	KT	KT			Aug 11
3.1	Chapter 4, 6 & 7 update	KT	KT	PE	PE	Aug 11
3.2	Chapter 7 update	KT	KT	PE	PE	Aug 11
			<i>KT/SA</i>		<i>P. Fen</i>	

March Area Transport Study

The market town of March is the second largest settlement in Fenland District. The aim of the March Area Transport Study is to build and interpret a transport model that can provide forecasts for the future land use planning for March and its surrounding area.

This document is the Traffic Forecasting Report.

Table of contents

Chapter	pages
Glossary of Abbreviations Used in this Report	7
1. Introduction	8
Background	9
This Report	9
2. Overview of Forecasting Process	10
2010 Base Year MATS Model	11
User Classes	12
Forecast Years and Scenarios	12
Forecasting Process	13
3. Forecast Year Scenario Definitions	14
Do Minimum	15
Do Something Test 1	17
Do Something Test 2	19
4. Forecast Year Networks	21
Do Minimum Networks	22
Do Something Test 1 and Do Something Test 2 Networks	23
Assignment Parameters	23
5. Future Year Demand	25
Do Minimum	26
Do Something Test 1	29
Do Something Test 2	29
Final Forecast Year Matrices	30
6. Forecasting Results	33
Model Convergence	34
Model Assignment Summary Statistics	34
Locations of Congestion Hot Spots	35
Link Flow Data for Key Corridors	47
Routing Analysis	50
Congestion Reference Flow	53
Turning Flow Data for Key Junctions	55
Journey Time Data	62
7. Summary	66
Tables	
Table 3.1 – Growth Factors (TEMPRO 6.1 & NRTF 2009) (2010 to 2016)	15
Table 3.2 – Growth Factors (TEMPRO 6.1 & NRTF 2009) (2010 to 2021)	16
Table 3.3 – Growth Factors (TEMPRO 6.1 & NRTF 2009) (2010 to 2026)	16
Table 3.4 – SFF Housing Growth Figures	17
Table 3.5 – SFF Opportunity Zone 1a and 1b Development Profile	18
Table 3.6 – SFF Opportunity Zone 2a and 2b Development Profile	20
Table 4.1 – Level Crossing Link Penalties	23
Table 4.2 – 2016 PPM and PPK Parameters	24
Table 4.3 – 2021 PPM and PPK Parameters	24

Table 4.4 – 2026 PPM and PPK Parameters	24
Table 5.1 – TRICS Trip Rates	29
Table 5.2 – Matrix Totals (DM)	30
Table 5.3 – Matrix Totals (DS1)	30
Table 5.4 – Matrix Total (DS2)	30
Table 5.5 – Sector to Sector Matrix (2010 Base Year, PM)	31
Table 5.6 – Sector to Sector Matrix (2026 DM, PM)	32
Table 5.7 – Sector to Sector Matrix (2026 DS1, PM)	32
Table 5.8 – Sector to Sector Matrix (2026 DS2, PM)	32
Table 6.1 – Congestion Hot Spots Summary	46
Table 6.2 – Traffic Flow Data (pcu) for B1101 High Street and A141 Isle of Ely Way	48
Table 6.3 – AADT/CRF Ratio for Key Links (See Figure 6.11 for Key Link Locations)	54
Table 6.4 – Total Junction Flow (2016)	59
Table 6.5 – Total Junction Flow (2021)	60
Table 6.6 – Total Junction Flow (2026)	61

Figures

Figure 2.1 – Overview of Forecasting Process	11
Figure 3.1 – Do Something Test 1 SFF Opportunity Zone Locations	18
Figure 3.2 – Do Something Test 2 SFF Opportunity Zone Locations	19
Figure 4.1 – 2010 Base Year Network vs Forecast Year Network	22
Figure 5.1 – Locations of the Known Committed Housing Developments	27
Figure 5.2 – Locations of the Known Committed Employment Developments	28
Figure 6.1 – Locations of Congestion Hot Spots (2010 Base, PM)	36
Figure 6.2 – Locations of Congestion Hot Spots (Forecast Year DM Scenarios, PM)	36
Figure 6.3 – Locations of Congestion Hot Spots (Forecast Year DS1 Scenarios, PM)	37
Figure 6.4 – Locations of Congestion Hot Spots (Forecast Year DS2 Scenarios, PM)	37
Figure 6.5 – B1101 High Street/B1099 St Peters Road Junction (2026 DM, PM)	39
Figure 6.6 – B1101 High Street/B1099 St Peters Road Junction (2026 DS1, PM)	39
Figure 6.7 – Junction V/C (2010, PM)	42
Figure 6.8 – Junction V/C (2016, PM)	43
Figure 6.9 – Junction V/C (2021, PM)	44
Figure 6.10 – Junction V/C (2026, PM)	45
Figure 6.11 – Key Links	47
Figure 6.12 – Traffic Growth Profile for B1101 and A141 (AM)	49
Figure 6.13 – Traffic Growth Profile for B1101 and A141 (IP)	49
Figure 6.14 – Traffic Growth Profile for B1101 and A141 (PM)	49
Figure 6.15 – Select Link Analysis (B1101) (2010 Base, PM)	50
Figure 6.16 – Select Link Analysis (A141) (2010 Base, PM)	51
Figure 6.17 – Select Link Analysis (B1101) (2026 DM, PM)	51
Figure 6.18 – Select Link Analysis (A141) (2026 DM, PM)	52
Figure 6.19 – Select Link Analysis (B1101) (2026 DS2, PM)	52
Figure 6.20 – Select Link Analysis (A141) (2026 DS2, PM)	53
Figure 6.21 – Flow Difference (2026 DM vs 2026 DS1, AM)	56
Figure 6.22 – Flow Difference (2026 DS2 vs 2026 DS1, AM)	57
Figure 6.23 – Key Junctions	58
Figure 6.24 – Journey Time Routes	62

Appendix

A. Calculation of PPM and PPK Values	69
Calculations of PPM and PPK Values	70
Introduction	70
Value to Time Costs: Pence per Minute	70
Distance Costs: Pence per Kilometer	77
PPM and PPK Parameters: Final Values	84
B. Sector to Sector Analysis	85
Sector to Sector Analysis	86

C. Convergence Statistics	97
Model Convergence Criteria	98
D. Model Assignment Summary Statistics	100
Model Assignment Summary Statistics	101
E. Link Data for Key Corridors	104
Link Data for Key Corridors	105
F. Traffic Flow Difference Plots	114
Traffic Flow Difference Plots	115
G. Journey Time Data	139
Journey Time Data	140
H. Junction Volume/Capacity Plots	150
Link and Junction Volume/Capacity Plots	151
I. Forecasting Methodology Note	192

Glossary of Abbreviations Used in this Report

Annual Average Daily Traffic	AADT
Cambridgeshire County Council	CCC
Congestion Reference Flow	CRF
Department for Transport	DfT
Design Manual for Roads and Bridges	DMRB
Do Minimum	DM
Do Something	DS
Employers' Business	EB
Fenland District Council	FDC
Home-Based Education	HBE _d
Home-Based Work	HBW
Inter Peak	IP
Light Goods Vehicle	LGV
Local Model Validation Report	LMVR
March Area Transport Study	MATS
Other Goods Vehicle Class 1 (Medium Goods Vehicle)	OGV1
Other Goods Vehicle Class 2 (Heavy Goods Vehicle)	OGV2
Other Trip Purpose	OTP
Passenger Car Unit	PCU
Pence per Kilometre	PPK
Pence per Minute	PPM
Shaping Fenland's Future	SFF
Simulation and Assignment of Traffic in Urban Road Networks	SATURN
Strategic Housing Land Availability Assessment	SHLAA
Trip End Model PROjection	TEMPRO
Traffic Forecasting Report	TFR
Transport Assessment	TA
Trip Rate Information Computer System	TRICS
User Class	UC
Value of Time	VOT
Vehicle Operating Cost	VOC
Volume/Capacity	V/C
Web Transport Analysis Guidance	WebTAG

1. Introduction

This document is the Traffic Forecasting Report. It describes the methodology and results of forecast year MATS SATURN highway models.

Introduction

Background

- 1.1. Atkins Transport Planning & Management was commissioned by Cambridgeshire County Council (CCC) and Fenland District Council (FDC) in July 2010 to undertake a transport study and produce a transport model for the market town of March.
- 1.2. The March Area Transport Study (MATS) sets out to review existing transport problems and issues and will examine a range of proposed measures and policies to improve the current transport system as well as meet the demand expected from future growth in the study area.
- 1.3. The base year SATURN highway model has been validated to represent existing traffic conditions, and it forms the basis for the forecast year modelling work.

This Report

- 1.4. This document is the Traffic Forecasting Report (TFR). It represents the culmination of the forecasting work that followed on from the base year highway model development, and provides traffic modelling results and data for the modelled forecast years.
- 1.5. The report is arranged in six chapters and ten appendices following this introduction:
 - Chapter 2 gives an overview of the forecasting methodology;
 - Chapter 3 defines the scenarios that are being investigated;
 - Chapter 4 gives details of the highway networks for the forecast years, along with other modelling parameters;
 - Chapter 5 describes the processes employed to generate forecast year demand matrices;
 - Chapter 6 presents the forecasting results and their analysis;
 - Chapter 7 summarises and concludes this report;
 - Appendix A contains the details of the calculation of the PPM and PPK parameters;
 - Appendix B provides sector to sector demand matrices for all forecast years;
 - Appendix C contains tables of convergence statistics for each assignment;
 - Appendix D contains tables of model assignment summary statistics;
 - Appendix E provides link data for the key corridors in the study area;
 - Appendix F contains flow difference plots from the SATURN models;
 - Appendix G presents the journey time graphs;
 - Appendix H presents the link and junction Volume/Capacity data for selected locations; and
 - Appendix I provides a copy of the Forecasting Methodology Note for reference.

2. Overview of Forecasting Process

This chapter provides a brief overview of the MATS model and the forecasting process.

Overview of the MATS Model and Forecasting Process

- 2.1. This chapter provides the basic information, such as modelled time periods and user classes, for the MATS model and an overview of the forecast scenarios and forecasting process.
- 2.2. Figure 2.1 below shows the basic forecasting steps and the methodology used to create the forecast year models for this study.

Figure 2.1 – Overview of Forecasting Process

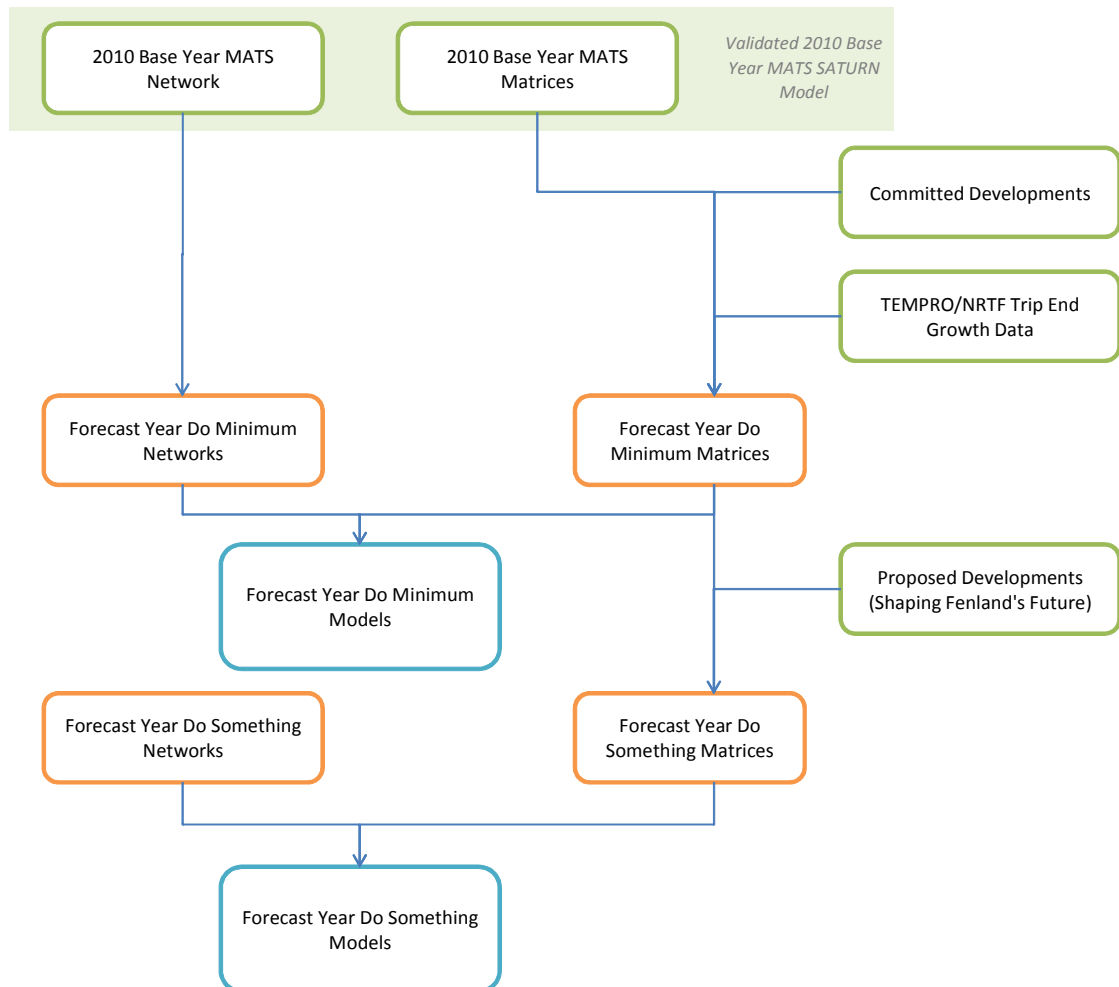

2010 Base Year MATS Model

- 2.3. The starting point for the forecasting process is the **2010 base year MATS** model: the development of this model was reported fully in the MATS Local Model Validation Report (LMVR). Three **time periods** have been modelled:
- AM peak hour (0800-0900);
 - Average inter peak hour (average of 1000-1600); and
 - PM peak hour (1700-1800).
- 2.4. The highway models were created using the SATURN software suite (**S**imulation and **A**ssignment of **T**raffic to **U**rban **R**oad **N**etworks) version 10.9.17 and external spreadsheet calculations. They consist of **demand matrices** that contain information about the origins and destinations of trips, and **networks** that define the road infrastructure (made up of links and nodes/junctions).

User Classes

- 2.5. The demand matrices are split into six types of traveller, known as **user classes**. These are defined and abbreviated as follows:
- 2.6. User Class 1 (**UC1**) – Home-Based Work (**HBW**) – light vehicles (cars, LGVs & motorcycles) making trips from home to place of work, or vice versa.
- 2.7. User Class 2 (**UC2**) – Home-Based Education (**HBEd**) – light vehicles making trips from home to place of education, or vice versa.
- 2.8. User Class 3 (**UC3**) – Employers' Business (**EB**) – light vehicle trips made during work time, i.e. not commuting but travelling for work purposes.
- 2.9. User Class 4 (**UC4**) – Other Trip Purposes (**OTP**) – light vehicles travelling for other purposes such as shopping, leisure, visiting friends/family, etc.
- 2.10. User Class 5 (**UC5**) – Other Goods Vehicles type 1 (**OGV1**) – defined as medium goods vehicles, assumed to be travelling for work purposes.
- 2.11. User Class 6 (**UC6**) – Other Goods Vehicles type 2 (**OGV2**) – defined as heavy goods vehicles, assumed to be travelling for work purposes.

Forecast Years and Scenarios

- 2.12. The **forecast years** for this study are
- 2016;
 - 2021; and
 - 2026.
- 2.13. For each Forecast Year, a set of **Do Minimum** (DM) models was created for each time period: these models include **committed developments** (i.e. those which have already been given planning permission and/or feature in the 2010 Strategic Housing Land Availability Assessment (SHLAA) document and 2007 Employment Land Review document; and background growth.).
- 2.14. Two Do Something (DS) scenarios were tested:
- Do Something Test 1 (DS1) – include the DM developments as above and developments within Shaping Fenland's Future (SFF) Opportunity Zone 1; and
 - Do Something Test 2 (DS2) – as DS1 above and developments within SFF Opportunity Zone 2.

Forecasting Process

2.15. The process followed to create the forecast models and this report can be broken down into four discrete steps:

- 1) **Build the forecast year model networks.** There are no committed infrastructure changes for the forecast years for the MATS network, and the node/link structure of the MATS forecast year models are very similar to the 2010 base year model, except for new accesses for new developments and longer level crossing barrier closure time.
- 2) **Build the forecast year demand matrices.** Starting from the 2010 base year demand matrices, the DM demand matrices are created by including committed developments to the base year matrices. The DS1 demand matrices include all the developments in the DM scenario and SFF Opportunity Zone 1. The DS2 demand matrices include all the developments in the DS1 scenario and SFF Opportunity Zone 2.
- 3) **Assign and converge the SATURN models.** This is an iterative process whereby the SATURN highway demand matrices are assigned to the future year networks to produce a converged solution, indicating how many trips travel along each link and where problems such as congestion may occur.
- 4) **Analyse the results.** Overall and detailed analysis is undertaken on each scenario, summarising the effects of each scenario on the study area.

3. Forecast Year Scenario Definitions

This chapter provides detailed housing and employment growth data for all forecast year scenarios.

Forecast Year Scenario Definitions

- 3.1. The forecast years for this study are 2016, 2021 and 2026; and the forecast scenarios for this study are Do Minimum (DM), Do Something Test 1 (DS1) and Do Something Test 2 (DS2). The definitions of these forecast year scenarios are given in the sections below.

Do Minimum

- 3.2. The DM scenario consists of all committed developments within March. For light vehicles, the total growth level is controlled to the levels as defined by TEMPRO 6.1 (Trip End Model PROjections) growth forecasts. For heavy vehicles, the total growth level is controlled to the levels as defined by National Road Traffic Forecast (NRTF) 2009 Revision 1.1. Table 3.1 to Table 3.3 below shows the growth factors for 2010 to 2016, 2021 and 2026 respectively.

Table 3.1 – Growth Factors (TEMPRO 6.1 & NRTF 2009) (2010 to 2016)

Vehicle Type	Area	Time Period	Trip End Growth	Fuel and Income Factor	Composite Factor
Light	March	AM	1.083	1.070	1.159
		IP	1.094	1.070	1.171
		PM	1.087	1.070	1.163
	Fenland	AM	1.075	1.070	1.150
		IP	1.084	1.070	1.160
		PM	1.078	1.070	1.153
	Cambridgeshire	AM	1.090	1.070	1.166
		IP	1.092	1.070	1.169
		PM	1.091	1.070	1.167
	Rest of Country	AM	1.070	1.070	1.145
		IP	1.069	1.070	1.144
		PM	1.070	1.070	1.145
Heavy (OGV1)	March	All	1.081	1.070	1.157
	Fenland	All	1.081	1.070	1.157
	Cambridgeshire	All	1.081	1.070	1.157
	Rest of Country	All	1.069	1.070	1.144
Heavy (OGV2)	March	All	1.013	1.070	1.084
	Fenland	All	1.013	1.070	1.084
	Cambridgeshire	All	1.013	1.070	1.084
	Rest of Country	All	0.994	1.070	1.064

Table 3.2 – Growth Factors (TEMPRO 6.1 & NRTF 2009) (2010 to 2021)

Vehicle Type	Area	Time Period	Trip End Growth	Fuel and Income Factor	Composite Factor
Light	March	AM	1.136	1.100	1.249
		IP	1.170	1.100	1.287
		PM	1.144	1.100	1.259
	Fenland	AM	1.121	1.100	1.234
		IP	1.153	1.100	1.268
		PM	1.129	1.100	1.242
	Cambridgeshire	AM	1.147	1.100	1.262
		IP	1.162	1.100	1.278
		PM	1.150	1.100	1.265
	Rest of Country	AM	1.115	1.100	1.227
		IP	1.118	1.100	1.230
		PM	1.115	1.100	1.227
Heavy (OGV1)	March	All	1.113	1.100	1.224
	Fenland	All	1.113	1.100	1.224
	Cambridgeshire	All	1.113	1.100	1.224
	Rest of Country	All	1.096	1.100	1.206
Heavy (OGV2)	March	All	1.082	1.100	1.190
	Fenland	All	1.082	1.100	1.190
	Cambridgeshire	All	1.082	1.100	1.190
	Rest of Country	All	1.049	1.100	1.154

Table 3.3 – Growth Factors (TEMPRO 6.1 & NRTF 2009) (2010 to 2026)

Vehicle Type	Area	Time Period	Trip End Growth	Fuel and Income Factor	Composite Factor
Light	March	AM	1.197	1.126	1.348
		IP	1.261	1.126	1.420
		PM	1.212	1.126	1.364
	Fenland	AM	1.176	1.126	1.324
		IP	1.236	1.126	1.392
		PM	1.190	1.126	1.340
	Cambridgeshire	AM	1.212	1.126	1.364
		IP	1.246	1.126	1.403
		PM	1.218	1.126	1.371
	Rest of Country	AM	1.163	1.126	1.309
		IP	1.171	1.126	1.319
		PM	1.164	1.126	1.310
Heavy (OGV1)	March	All	1.144	1.126	1.288
	Fenland	All	1.144	1.126	1.288
	Cambridgeshire	All	1.144	1.126	1.288
	Rest of Country	All	1.124	1.126	1.266
Heavy (OGV2)	March	All	1.153	1.126	1.298
	Fenland	All	1.153	1.126	1.298
	Cambridgeshire	All	1.153	1.126	1.298
	Rest of Country	All	1.107	1.126	1.246

Housing and Employment Developments

- 3.3. The DM scenario consists of all committed housing and employment developments as outlined in the MATS Forecasting Methodology Note (included in Appendix I for reference).
- 3.4. Table 3.4 shows the committed housing developments within March that have been defined the Shaping Fenland's Future Stage 2 Report.

Table 3.4 – SFF Housing Growth Figures

March	Number of Dwellings
Extant	491
Urban Capacity Sites	97
Extra Urban Capacity Sites	199
Windfall	379
Affordable Exceptions	29
Urban Sub-Total	1194

Table extracted from Page 68, Chapter 7, Shaping Fenland's Future, Stage 2 Report V0.1

- 3.5. Where known housing development sites have been identified, the trips associated with the developments have been distributed into specific zones, representative of the geographical location of the sites. For employment developments, existing planning application documents for all committed employment developments have been reviewed. Similar to the housing developments, trips associated with known employment development sites have been distributed into specific zones. The remaining growth was then distributed amongst the remaining zones in March, and the overall growth has been controlled to the TEMPRO 6.1 levels.
- 3.6. It was assumed that all committed developments will be completed by 2016, and would therefore be included in all forecast year DM scenarios.

Model Network

- 3.7. There are no additional infrastructure changes included as part of this scenario, with the exception of some additional zone connection locations to facilitate the large committed developments. Zone connections for all SFF Opportunity Zones have also been included, such that the networks do not differ between the DM and DS scenarios.
- 3.8. Minor network changes, including longer closure time for the level crossing (See Paragraph 4.4) and network parameters (i.e. PPM & PPK) have been incorporated into the DM forecast year networks.

Do Something Test 1

- 3.9. The DS1 scenario includes all the committed developments included in the DM scenario and developments from the SFF Opportunity Zone 1a and 1b. The locations of the site are shown in Figure 3.1, and the size of development for Zone 1b is approximately twice as Zone 1a.
- 3.10. The level of housing and employment developments in the SFF Opportunity Zone 1a and 1b (for 2010 to 2016, 2016 to 2021 and 2021 and 2026 as well as cumulative totals) are described in Table 3.5.
- 3.11. Similar to the DM scenario, the overall growth for DS1 scenario has been controlled to the TEMPRO 6.1 levels (Table 3.1 to Table 3.3), and as such the total level of traffic for DS1 is the same as for the DM. However, the distribution will be altered such that there is a larger proportion of traffic coming from the areas of the SFF Opportunity Zones.

Figure 3.1 – Do Something Test 1 SFF Opportunity Zone Locations

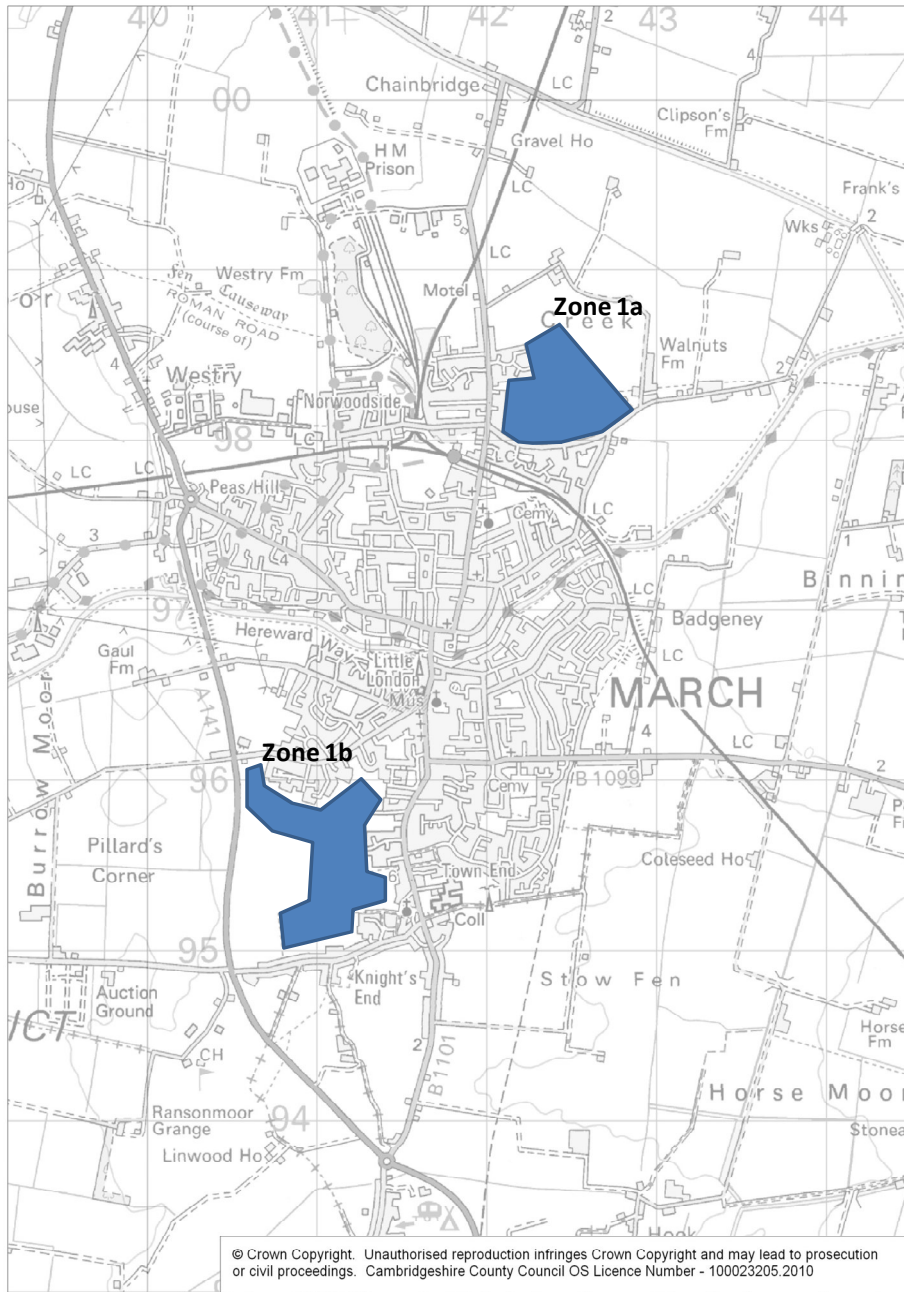

Table 3.5 – SFF Opportunity Zone 1a and 1b Development Profile

Development Type	2010 to 2016			2016 to 2021			2021 to 2026		
	Z1a	Z1b	TOT	Z1a	Z1b	TOT	Z1a	Z1b	TOT
Number of Houses	200	400	600	292	583	875	150	300	450
<i>Cumulative Total</i>	-	-	-	492	983	1475	642	1283	1925
Hectares of Employment	3.57	7.13	10.70	2.97	5.93	8.90	3.00	6.00	9.00
<i>Cumulative Total</i>	-	-	-	6.54	13.06	19.60	9.54	19.06	28.60

Development profile based on trajectory data from Page 78, Chapter 7, Shaping Fenland's Future, Stage 2 Report V0.1

Model Network

3.12. There are no network changes between the DS1 and DM scenario.

Do Something Test 2

- 3.13. The DS2 scenario includes the developments included in the DS1 scenario and the developments from Opportunity Zone 2a and 2b. The locations of the site are shown in Figure 3.2, and the sizes of development for Zone 2a and Zone 2b were assumed to be identical.
- 3.14. The level of housing development in the SFF Opportunity Zone 2a and 2b (for 2010 to 2016, 2016 to 2021 and 2021 and 2026 as well as cumulative totals) are described in Table 3.5. There are no employment developments in Opportunity Zone 2a and 2b.
- 3.15. It should be noted that there are no developments for Opportunity Zone 2a and 2b in 2016, and as such there are no 2016 DS2 models.
- 3.16. The demand for the developments in Opportunity Zone 2a and 2b have been applied to the DS1 demand matrices directly and as such the growth for DS2 scenario is in excess of the TEMPRO 6.1 growth and is greater than for the DM or DS scenarios.

Figure 3.2 – Do Something Test 2 SFF Opportunity Zone Locations

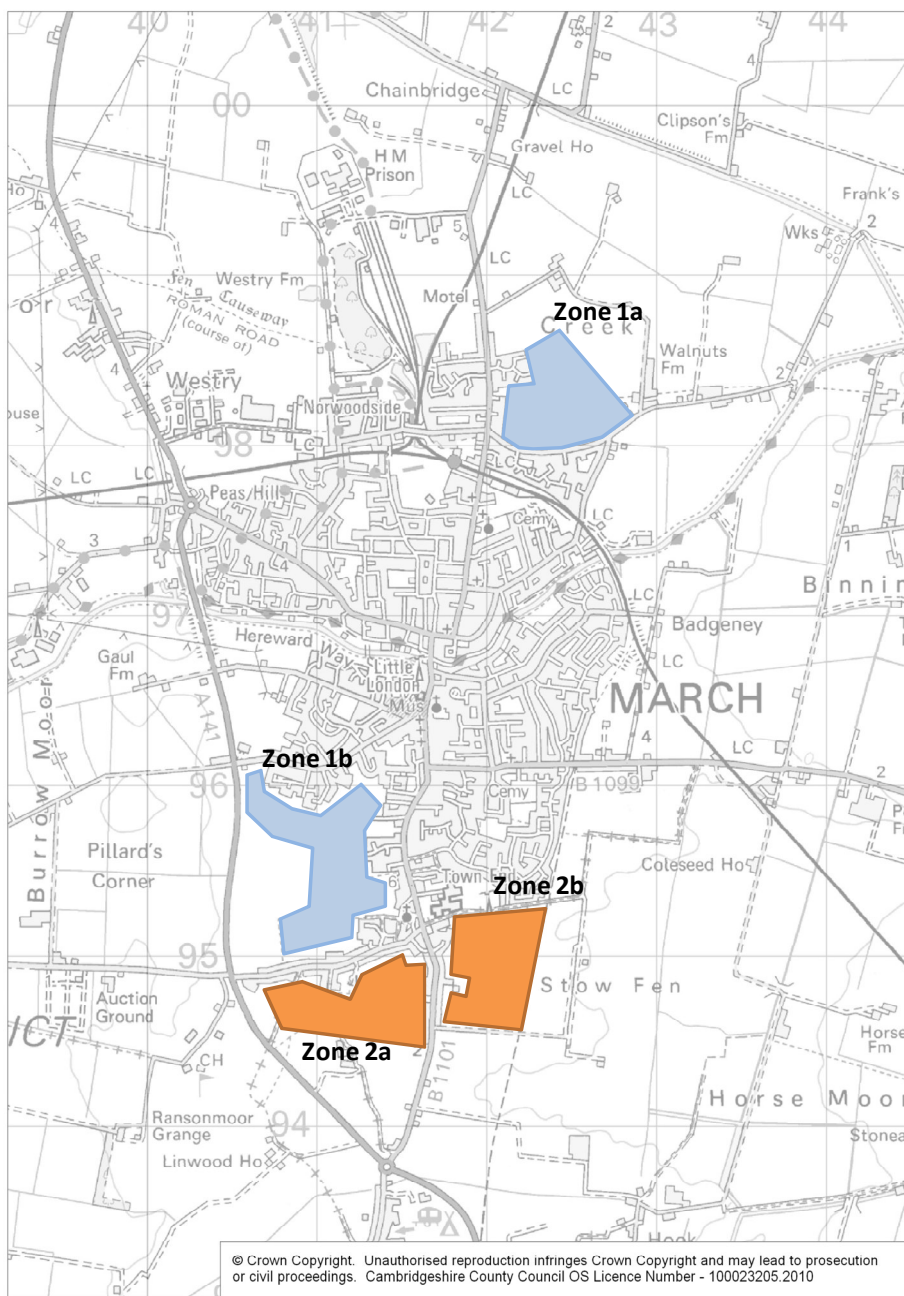

Table 3.6 – SFF Opportunity Zone 2a and 2b Development Profile

Development Type	2010 to 2016			2016 to 2021			2021 to 2026		
	Z2a	Z2b	TOT	Z2a	Z2b	TOT	Z2a	Z2b	TOT
Number of Houses	0	0	0	25	25	50	388	387	775
<i>Cumulative Total</i>	-	-	-	25	25	50	413	412	825
Hectares of Employment	0	0	0	0	0	0	0	0	0
<i>Cumulative Total</i>	-	-	-	0	0	0	0	0	0

Development profile based on trajectory data from Page 78, Chapter 7, Shaping Fenland's Future, Stage 2 Report V0.1

Model Network

3.17. There are no network changes between the DS2 and DM scenario.

4. Forecast Year Networks

This chapter discusses the model network coding that makes up each forecast year network of the SATURN model.

Forecast Year Networks

Do Minimum Networks

- 4.1. There are very few network changes between the 2010 base year MATS network and the forecast year DM network. There are no committed infrastructure changes for all forecast years, and the changes to the network are limited to access and zone connections to facilitate the developments zones and minor changes to reflect longer level crossing closure time in the forecast year.
- 4.2. Figure 4.1 shows the network changes between the 2010 base year model and the forecast year DM network.
- 4.3. It should be noted that:
- all accesses for the SFF Opportunity zones have not been modelled in detail and the potential delay for the development access points have not been considered as detailed development access junction designs are not available at this stage. The accesses coded currently simply provide a way for the development traffic to enter the network. Further modelling work and analysis should be undertaken when detailed development access points are available to reassess the impacts of the developments on junctions in the close proximity of the development sites.
 - although the connection for SFF Opportunity Zone 1a, 1b, 2a and 2b are present in the DM network, there are no demand for these zones in the DM scenarios. Also, the network structure is identical for all forecast years.

Figure 4.1 – 2010 Base Year Network vs Forecast Year Network

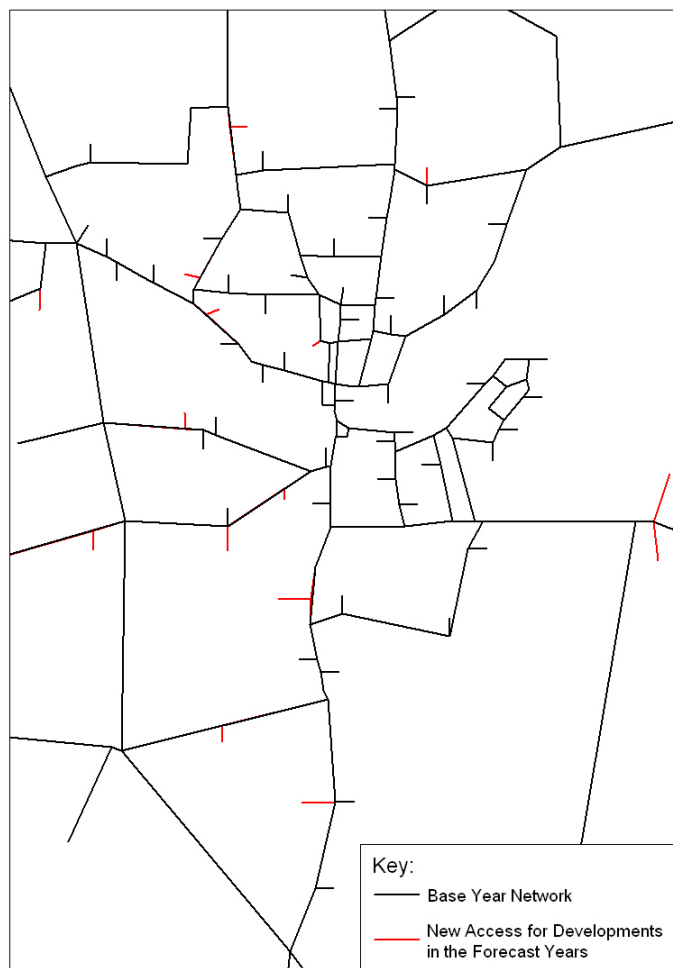

- 4.4. It is expected that the level crossing closure time will increase in the future. For the 2010 base year, the average level crossing closure time is 6 min 42 sec, 11 min 45 sec and 9 min 32 sec for the AM, inter and PM peak respectively. For 2016 and 2021, it is expected that there will be negligible increase in level crossing closure time. For 2026, it is estimated that the level crossing closure time will increase by approximately 45% to 9 min 43 sec, 17 min 2 sec and 13 min 49 sec for the AM, inter and PM peak respectively (based on the *East Cambridgeshire, Summary of Freight Outputs Report* by MDS Transmodal Limited). The link penalties for all approach links to the level crossings for the 2026 networks have been updated to reflect the increase in closure time. It should be noted that as the delay caused by the level crossings are coded as link penalties, it will not be included in the link delay statistics but will be included in the journey time data and will influence traffic routing in the network. Table 4.1 below summarises the link penalty values used for the Station Road level crossing.

Table 4.1 – Level Crossing Link Penalties

Model Year		AM	IP	PM
Base/2016/2021	Average Closure Time per Hour	6m42s	11m45s	9m32s
	% of Hour Closed	11%	20%	16%
	Link Penalty (i.e. delay per veh)	6s	12s	11s
2026	Average Closure Time per Hour	9m43s	17m2s	13m49s
	% of Hour Closed	16%	28%	23%
	Link Penalty (i.e. delay per veh)	8s	17s	16s

Do Something Test 1 and Do Something Test 2 Networks

- 4.5. Since neither of the DS scenarios included any infrastructure improvements, no further changes to the network were required for both DS1 and DS2 networks.

Assignment Parameters

- 4.6. As well as the changes to facilitate the additional zone connections and the increase in level crossing closure time, the SATURN network files contain assignment parameters that determine the behaviour of the model. The majority of these parameters have been left unchanged from the base year networks, with the following exceptions:
- Two parameters define the relative weightings of importance of time and distance for each user class: these are called Pence Per Minute (PPM) and Pence Per Kilometre (PPK) in SATURN. These parameters are predicted to change through time, and therefore have been recalculated for the forecast year networks. Further details are given below.
 - The SIGOPT parameter has been used such that the signal timings are optimised for the forecast year traffic flows. In reality this is a process that would occur, so it is representative of forecast year conditions to have the timings optimised. The signal timing optimisation process has been restricted to traffic signals only and timings for pedestrian crossings are not affected.
 - The convergence criterion, Flow Change Stability (P) has been set to 95% for all forecast year models. A more stringent criterion of 'P' value of 99% has been used for the base year model, but as the traffic demand increases in the forecast year model, it is reasonable to relax this criterion. The DMRB states that transport models should aim for values of 'P' greater than 90%, therefore the 'P' value used for forecast year MATS model are still well within the guidance.
- 4.7. It should be noted that the values of PPM and PPK parameters do not vary according to the different test scenarios: only by year, time period and user class.

PPM and PPK

- 4.8. PPM and PPK represent the travellers' concept of their values of time and distance for each journey, and the ratio between them. The interaction of these parameters has a significant effect on route choice: if time is highly valued but distance is not, then the quickest route will be chosen no matter how far it is; conversely, if distance is highly valued but time is not, then the shortest

route would be chosen no matter how slow it is. Usually, the route choice is a fine balance between the relative importance of time and distance to the traveller.

- 4.9. These parameters are predicted to change through time: they were calculated for the 2010 base year (as described in the MATS Local Model Validation Report), and have been calculated using the same method for the forecast years. This method follows the guidance given in WebTAG 3.5.6D (dated March 2010). Full details of the calculations are given in Appendix A; the resulting values that were used in the models are presented in Table 4.2 to Table 4.4 below.

Table 4.2 – 2016 PPM and PPK Parameters

User Class	Absolute Values (2002 prices)						Model Parameters					
	AM		IP		PM		AM		IP		PM	
	PPM	PPK	PPM	PPK	PPM	PPK	PPM	PPK	PPM	PPK	PPM	PPK
UC1	10.82	9.40	11.21	9.39	11.30	9.16	1.00	0.87	1.00	0.84	1.00	0.81
UC2	20.68	8.90	14.96	8.73	18.63	8.89	1.00	0.43	1.00	0.58	1.00	0.48
UC3	37.92	11.59	37.71	11.52	43.68	11.34	1.00	0.31	1.00	0.31	1.00	0.26
UC4	12.72	9.14	12.91	8.95	13.23	9.20	1.00	0.72	1.00	0.69	1.00	0.70
UC5	21.79	23.54	19.97	23.34	25.68	23.74	1.00	1.08	1.00	1.17	1.00	0.92
UC6	17.12	43.63	17.12	42.86	17.12	44.20	1.00	2.55	1.00	2.50	1.00	2.58

Table 4.3 – 2021 PPM and PPK Parameters

User Class	Absolute Values (2002 prices)						Model Parameters					
	AM		IP		PM		AM		IP		PM	
	PPM	PPK	PPM	PPK	PPM	PPK	PPM	PPK	PPM	PPK	PPM	PPK
UC1	11.56	8.88	11.99	8.86	12.08	8.60	1.00	0.77	1.00	0.74	1.00	0.71
UC2	22.10	8.29	15.99	8.10	19.91	8.28	1.00	0.38	1.00	0.51	1.00	0.42
UC3	41.19	11.33	40.97	11.26	47.45	11.01	1.00	0.28	1.00	0.27	1.00	0.23
UC4	13.59	8.58	13.79	8.36	14.14	8.64	1.00	0.63	1.00	0.61	1.00	0.61
UC5	23.67	23.91	21.69	23.68	27.89	24.14	1.00	1.01	1.00	1.09	1.00	0.87
UC6	18.60	44.37	18.60	43.55	18.60	44.99	1.00	2.39	1.00	2.34	1.00	2.42

Table 4.4 – 2026 PPM and PPK Parameters

User Class	Absolute Values (2002 prices)						Model Parameters					
	AM		IP		PM		AM		IP		PM	
	PPM	PPK	PPM	PPK	PPM	PPK	PPM	PPK	PPM	PPK	PPM	PPK
UC1	12.36	8.30	12.81	8.28	12.91	7.98	1.00	0.67	1.00	0.65	1.00	0.62
UC2	23.63	7.63	17.09	7.41	21.28	7.62	1.00	0.32	1.00	0.43	1.00	0.36
UC3	44.75	11.05	44.51	10.97	51.55	10.66	1.00	0.25	1.00	0.25	1.00	0.21
UC4	14.53	7.96	14.74	7.70	15.12	8.03	1.00	0.55	1.00	0.52	1.00	0.53
UC5	25.71	24.30	23.57	24.04	30.30	24.58	1.00	0.95	1.00	1.02	1.00	0.81
UC6	20.20	45.13	20.20	44.29	20.20	45.88	1.00	2.23	1.00	2.19	1.00	2.27

5. Future Year Demand

This chapter describes the process used to generate the forecast year demand matrices.

Forecast Year Demand

- 5.1. This chapter outlines the methodology adopted to produce the 2016, 2021 and 2026 demand matrices for the MATS SATURN model. The process uses several different growth sources:
- TEMPRO 6.1 provides projections of growth over time for use in local and regional transport models. It presents projections of growth in planning data, car ownership, and resultant growth in trip-making by different modes of transport under a constant cost assumption. The information is provided for over 2,500 zones, and can be aggregated into towns, districts or counties. For this study, trip end growth data for March, Fenland, Cambridgeshire and Rest of Country has been extracted (as shown in Table 3.1 to Table 3.3) from TEMPRO and is used to provide forecasts of all light vehicle user classes (i.e. UC1 to UC4).
 - For the heavy vehicle user classes (i.e. UC5 & UC6), trip end growth factors from NRTF 2009 was used. The NRTF 2009 published by Department for Transport (DfT) provides forecasts of road traffic growth by region and by vehicle type.
 - The SHLAA document, 2007 Employment Land Review document and other planning application data provide information on the committed housing and employment developments in and around March which are included in all forecast year scenarios (i.e. DM, DS1 & DS2).
 - The Shaping Fenland's Future document provides housing and employment information to be included in the DS1 and DS2 scenarios.
 - TRICS (Trip Rate Information Computer System) is a database of surveys from developments across the county, which can be interrogated to provide an estimate of the number of trips that will be generated by a new development. The information can be tailored to suit the individual development, taking into account trends in that areas of the country, and/or location of the development within or outside a town, and/or its size etc.
- 5.2. The forecast year demand matrices were calculated separately for each user class, time period, forecast year and scenario.

Do Minimum

- 5.3. As discussed in Paragraph 3.5, where known housing and employment development sites have been identified, the trips associated with the developments have been distributed into specific zones, representative of the geographical location of the sites. The remaining growth was then distributed amongst the remaining zones in March, and the overall growth has been controlled to the TEMPRO 6.1 levels.
- 5.4. Figure 5.1 and Figure 5.2 below shows the locations of the known housing and employment development sites and the level of AM peak trips (total arrival and departure) associated with the developments based on the MATS zone plan. The purpose of these plots are to show the approximately location and size of the known developments. Inter and PM peak plots were also produced but have not been included in this report as the figures for the inter and PM peak are almost identical to the AM peak.

Figure 5.1 – Locations of the Known Committed Housing Developments

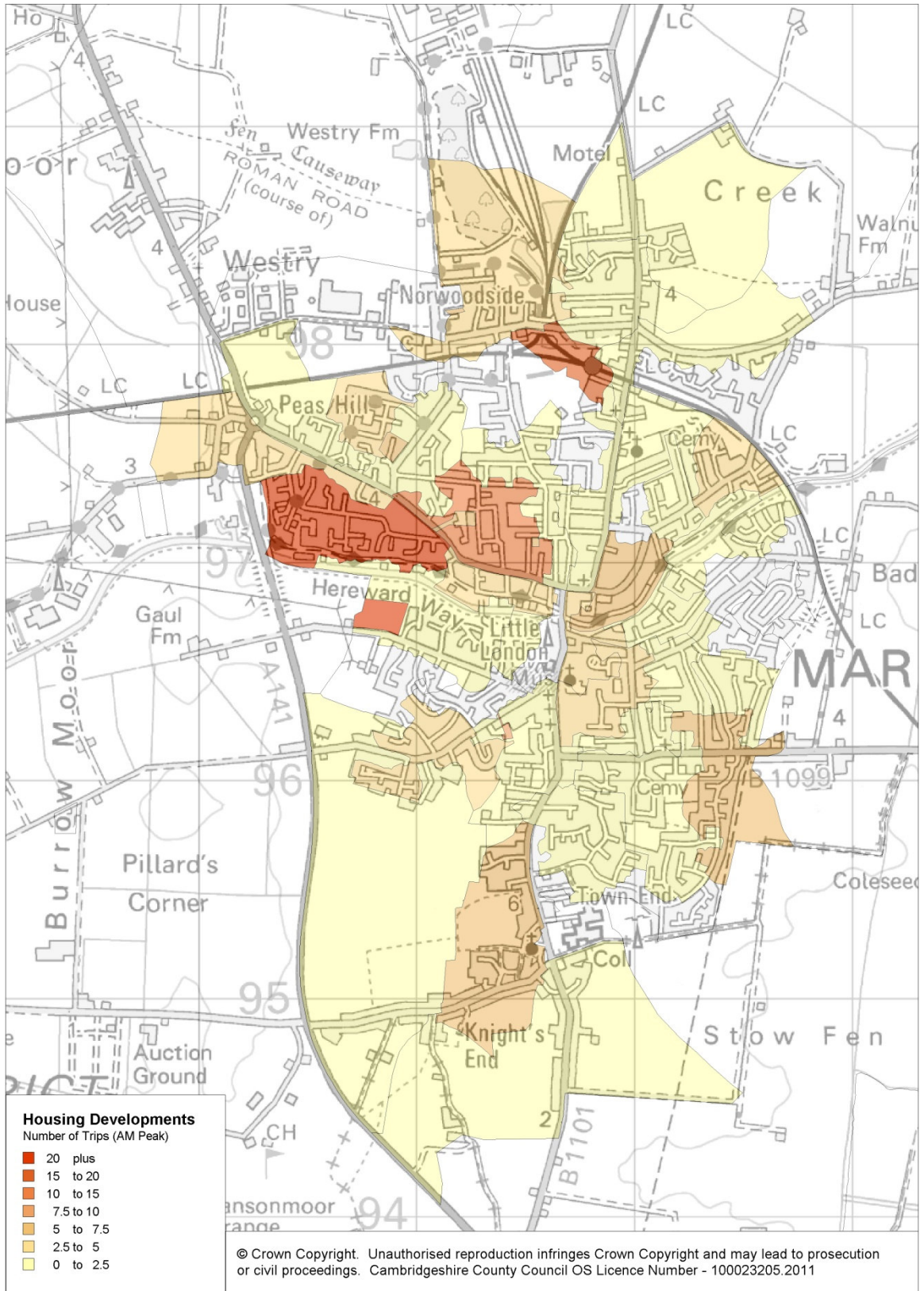
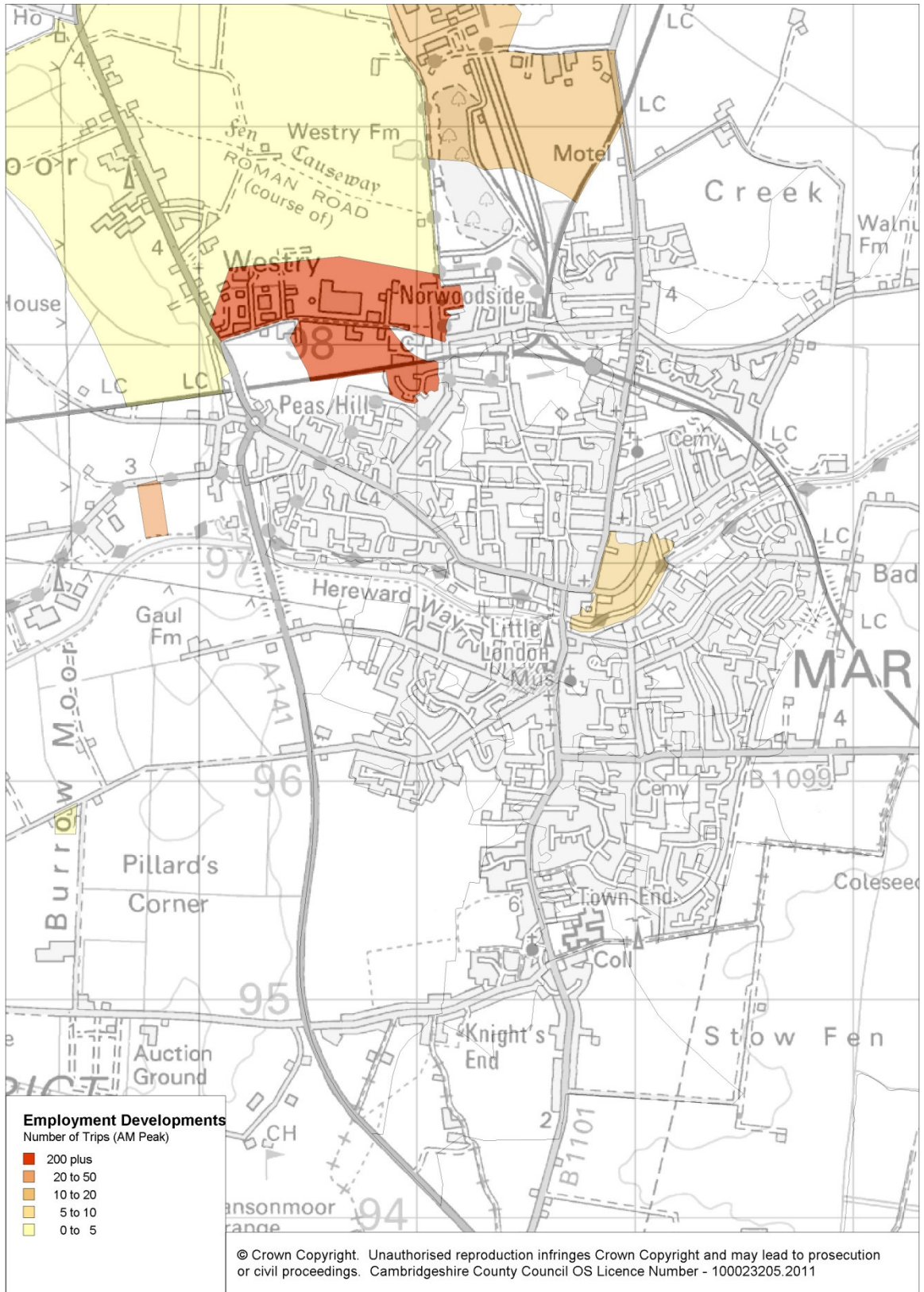

Figure 5.2 – Locations of the Known Committed Employment Developments



5.5. To calculate the trip generation/attraction for the known developments, trip rates from TRICS were used. Table 5.1 below shows the trip rates used for this study. Where available, Transport Assessment (TA) documents were examined, and trip generation/attraction data from the TA was used.

Table 5.1 – TRICS Trip Rates

Development	Unit	AM Peak			Inter Peak			PM Peak		
		Arr	Dep	TOT	Arr	Dep	TOT	Arr	Dep	TOT
Housing	Per dwelling	0.18	0.37	0.55	0.22	0.20	0.42	0.34	0.22	0.56
Employment (Office)	Per 100 sqm GFA	2.12	0.30	2.42	0.54	0.55	1.09	0.18	1.85	2.03
Employment (Industrial Unit)	Per 100 sqm GFA	0.55	0.14	0.69	0.21	0.20	0.41	0.02	0.50	0.52
Employment (Warehousing)	Per 100 sqm GFA	0.28	0.15	0.43	0.14	0.15	0.29	0.11	0.29	0.40
Employment (Parcel Distribution Centres)	Per 100 sqm GFA	0.38	0.82	1.20	0.35	0.35	0.70	1.11	1.26	2.37

Arr = Arrival; Dep = Departure; TOT = Total; GFA = Gross Floor Area.

- 5.6. After applying the trip end growth for the known developments, the remaining growth has been distributed amongst the remaining zones and finally controlled to the TEMPRO 6.1 levels. At the end of this process, a set of forecast year DM trip ends were generated. To distribute the trip ends, a gravity model and the Furness process (similar to the process used to generate the synthetic parts of the base year matrices, as discussed in the MATS LMVR) was used to produce the full DM demand matrices.
- 5.7. It should be noted that all DM known developments are expected to be completed by 2016, therefore the difference between the 2016, 2021 and 2026 is the background growth controlled by TEMPRO 6.1 only.

Do Something Test 1

- 5.8. Using the same trip rates as the DM scenario, the trips associated with the developments for SFF Opportunity Zone 1a and 1b (as shown in Table 3.5) were calculated as well as for the known developments (included in the DM scenario). Similar to the DM trip ends, the overall growth was controlled to TEMPRO 6.1 levels. The forecast year DS1 trip ends were then distributed using a gravity model the Furness process to produce a set of forecast year DS1 demand matrices.
- 5.9. As discussed previously, as both DM and DS1 scenarios are controlled to the TEMPRO 6.1 levels, the overall demand matrix totals for these two scenarios are the same but with different demand distribution.

Do Something Test 2

- 5.10. Using the same trip rates as the DM scenario, the trips associated with the developments for SFF Opportunity Zone 2a and 2b (as shown in Table 3.6) were calculated. These trips were then added to the DS1 matrices by distributing them based on the DS1 trip ends. The demand matrices for this scenario are in excess of the TEMPRO 6.1 level, and as such, the matrix totals for DS2 scenario is greater than both DM and DS1 scenarios.

Final Forecast Year Matrices

Matrix Totals

- 5.11. Table 5.2 to Table 5.4 below show the demand matrix totals for all forecast years, time periods and modelled scenarios.
- 5.12. As discussed in Chapter 3, the matrix totals for the DM and DS1 scenarios are controlled to the same levels (i.e. TEMPRO 6.1), and the matrix totals for these two scenarios are almost identical, except for very small difference due to rounding.
- 5.13. The demand for DS2 is higher than DM and DS1, as it includes the SFF Opportunity Zone 2a and 2b developments which have been added to the DS1 matrices, in excess of the TEMPRO 6.1 growth levels. It should also be noted that there are no 2016 DS2 models as there are no developments for SFF Opportunity Zone 2a and 2b for 2016.

Table 5.2 – Matrix Totals (DM)

Scenario		AM	IP	PM
2010 Base		6,420	5,306	6,912
2016 DM		7,410	6,131	7,973
2016 DM – 2010 Base	Difference	990	825	1,061
	% Difference	15.4%	15.6%	15.3%
2021 DM		7,990	6,691	8,650
2021 DM – 2010 Base	Difference	1,570	1,385	1,738
	% Difference	24.5%	26.1%	25.1%
2026 DM		8,619	7,317	9,400
2026 DM – 2010 Base	Difference	2,199	2,011	2,488
	% Difference	34.2%	37.9%	36.0%

Table 5.3 – Matrix Totals (DS1)

Scenario		AM	IP	PM
2010 Base		6,420	5,306	6,912
2016 DS1		7,415	6,135	7,975
2016 DS1 – 2010 Base	Difference	995	829	1,063
	% Difference	15.5%	15.6%	15.4%
2021 DS1		7,988	6,696	8,654
2021 DS1 – 2010 Base	Difference	1,568	1,390	1,742
	% Difference	24.4%	26.2%	25.2%
2026 DS1		8,618	7,321	9,403
2026 DS1 – 2010 Base	Difference	2,198	2,015	2,491
	% Difference	34.2%	38.0%	36.0%

Table 5.4 – Matrix Total (DS2)

Scenario		AM	IP	PM
2010 Base		6,420	5,306	6,912
2021 DS2		8,015	6,716	8,681
2021 DS2 – 2010 Base	Difference	1,595	1,410	1,769
	% Difference	24.8%	26.6%	25.6%
2026 DS2		9,040	7,632	9,824
2026 DS2 – 2010 Base	Difference	2,620	2,326	2,912
	% Difference	40.8%	43.8%	42.1%

Sector to Sector Analysis

- 5.14. To show the change in trip distribution pattern in the forecast years, the demand matrices were aggregated using the MATS 8 sector system (See Appendix B for sector plan) and the sector to sector movements compared.
- 5.15. As the matrix totals show the PM peak is forecasted to have greatest increase in traffic demand, analysis to summarise the matrices at a sector to sector level was undertaken for this peak period only. Also to understand the full impact of the SFF Opportunity Zone developments, the analysis has been undertaken on the 2026 demand matrices.
- 5.16. Table 5.5 to Table 5.8 shows the PM peak sector to sector matrices for 2010 base year, DM, DS1 and DS2 scenarios. Sector to sector matrices for all other time periods are included in Appendix B for reference.
- 5.17. The sector to sector matrices below show that the trip distribution between 2010 base year and 2026 DM is broadly similar as might be expected. The committed developments included in the DM scenario are located throughout March and the overall trip distribution for the DM scenario remains similar to the base.
- 5.18. Comparison between the 2026 DM and DS1 trip distribution shows that there is an increase in trip ends for Sector 3 and decrease in trip ends for Sector 2 in the DS1 scenario. The DS1 scenario includes developments for SFF Opportunity Zone 1a (which is within Sector 1) and 1b (which is within Sector 3). As the growth for March for DM and DS1 are controlled to the same TEMPRO 6.1 growth level, the growth for the Opportunity Zones are balanced by reduced background growth in other remaining March zones.
- 5.19. For Sector 1, which contains the smaller Opportunity Zone 1a, the overall trip ends remain fairly consistent as the increase in trips to/from the Opportunity Zone 1a is balanced out with the decrease in background growth for the remaining zones in this sector. For Sector 3, which contains the larger Opportunity Zone 1b, the overall trip ends increases as trips associated with Opportunity Zone 1b is greater than the reduction in trips due to the lower background growth. For Sector 2, which includes background growth only, the overall trip ends reduce.
- 5.20. For DS2 scenario, the trips associated with Opportunity Zone 2a and 2b have been added to the DS1 matrices. As Opportunity Zone 2a is within Sector 3 and Opportunity Zone 2b is within Sector 6, there are increases in trips to/from these two sectors in the DS2 matrix when compared to the DS1 matrix whilst the trips to/from other sectors remain identical between the DS2 and DS1 scenario.

Table 5.5 – Sector to Sector Matrix (2010 Base Year, PM)

		Origin								TOT
		1	2	3	4	5	6	7	8	
Destination	1	182 (3%)	173 (3%)	227 (3%)	183 (3%)	4 (0%)	126 (2%)	114 (2%)	96 (1%)	1103 (16%)
	2	164 (2%)	200 (3%)	152 (2%)	82 (1%)	12 (0%)	112 (2%)	63 (1%)	103 (1%)	887 (13%)
	3	147 (2%)	156 (2%)	176 (3%)	98 (1%)	18 (0%)	218 (3%)	68 (1%)	78 (1%)	960 (14%)
	4	338 (5%)	102 (1%)	182 (3%)	506 (7%)	11 (0%)	350 (5%)	111 (2%)	99 (1%)	1699 (25%)
	5	9 (0%)	6 (0%)	12 (0%)	18 (0%)	0 (0%)	9 (0%)	7 (0%)	6 (0%)	68 (1%)
	6	82 (1%)	87 (1%)	181 (3%)	227 (3%)	9 (0%)	109 (2%)	36 (1%)	97 (1%)	828 (12%)
	7	170 (2%)	159 (2%)	139 (2%)	179 (3%)	3 (0%)	86 (1%)	6 (0%)	58 (1%)	799 (12%)
	8	72 (1%)	130 (2%)	109 (2%)	105 (2%)	4 (0%)	69 (1%)	40 (1%)	39 (1%)	568 (8%)
	TOT	1164 (17%)	1012 (15%)	1178 (17%)	1397 (20%)	60 (1%)	1079 (16%)	445 (6%)	576 (8%)	6912 (100%)

Table 5.6 – Sector to Sector Matrix (2026 DM, PM)

		Origin								
		1	2	3	4	5	6	7	8	TOT
Destination	1	250 (3%)	242 (3%)	316 (3%)	267 (3%)	4 (0%)	149 (2%)	150 (2%)	122 (1%)	1500 (16%)
	2	230 (2%)	284 (3%)	230 (2%)	123 (1%)	14 (0%)	124 (1%)	83 (1%)	140 (1%)	1228 (13%)
	3	214 (2%)	228 (2%)	281 (3%)	151 (2%)	21 (0%)	273 (3%)	78 (1%)	109 (1%)	1356 (14%)
	4	495 (5%)	143 (2%)	291 (3%)	693 (7%)	16 (0%)	476 (5%)	129 (1%)	157 (2%)	2400 (26%)
	5	13 (0%)	7 (0%)	16 (0%)	7 (0%)	0 (0%)	30 (0%)	8 (0%)	3 (0%)	83 (1%)
	6	99 (1%)	97 (1%)	221 (2%)	345 (4%)	10 (0%)	103 (1%)	41 (0%)	96 (1%)	1012 (11%)
	7	213 (2%)	210 (2%)	175 (2%)	296 (3%)	4 (0%)	101 (1%)	9 (0%)	74 (1%)	1081 (12%)
	8	91 (1%)	168 (2%)	136 (1%)	156 (2%)	5 (0%)	79 (1%)	54 (1%)	50 (1%)	740 (8%)
	TOT	1605 (17%)	1378 (15%)	1664 (18%)	2038 (22%)	76 (1%)	1335 (14%)	551 (6%)	753 (8%)	9400 (100%)

Table 5.7 – Sector to Sector Matrix (2026 DS1, PM)

		Origin								
		1	2	3	4	5	6	7	8	TOT
Destination	1	274 (3%)	176 (2%)	491 (5%)	194 (2%)	5 (0%)	109 (1%)	119 (1%)	89 (1%)	1458 (16%)
	2	95 (1%)	119 (1%)	133 (1%)	61 (1%)	7 (0%)	83 (1%)	52 (1%)	86 (1%)	636 (7%)
	3	470 (5%)	346 (4%)	616 (7%)	165 (2%)	22 (0%)	208 (2%)	68 (1%)	90 (1%)	1987 (21%)
	4	396 (4%)	103 (1%)	235 (2%)	723 (8%)	19 (0%)	580 (6%)	165 (2%)	183 (2%)	2404 (26%)
	5	7 (0%)	6 (0%)	19 (0%)	30 (0%)	0 (0%)	9 (0%)	8 (0%)	5 (0%)	84 (1%)
	6	82 (1%)	81 (1%)	184 (2%)	356 (4%)	9 (0%)	116 (1%)	56 (1%)	130 (1%)	1013 (11%)
	7	172 (2%)	152 (2%)	156 (2%)	341 (4%)	6 (0%)	136 (1%)	15 (0%)	104 (1%)	1082 (12%)
	8	86 (1%)	132 (1%)	118 (1%)	169 (2%)	6 (0%)	95 (1%)	69 (1%)	66 (1%)	740 (8%)
	TOT	1582 (17%)	1116 (12%)	1952 (21%)	2038 (22%)	76 (1%)	1336 (14%)	551 (6%)	753 (8%)	9403 (100%)

Table 5.8 – Sector to Sector Matrix (2026 DS2, PM)

		Origin								
		1	2	3	4	5	6	7	8	TOT
Destination	1	274 (3%)	176 (2%)	512 (5%)	194 (2%)	5 (0%)	128 (1%)	119 (1%)	89 (1%)	1498 (15%)
	2	95 (1%)	119 (1%)	162 (2%)	61 (1%)	7 (0%)	111 (1%)	52 (1%)	86 (1%)	693 (7%)
	3	483 (5%)	365 (4%)	689 (7%)	172 (2%)	26 (0%)	270 (3%)	69 (1%)	92 (1%)	2166 (22%)
	4	396 (4%)	103 (1%)	248 (3%)	723 (7%)	19 (0%)	591 (6%)	165 (2%)	183 (2%)	2427 (25%)
	5	7 (0%)	6 (0%)	26 (0%)	30 (0%)	0 (0%)	15 (0%)	8 (0%)	5 (0%)	97 (1%)
	6	93 (1%)	98 (1%)	234 (2%)	361 (4%)	12 (0%)	125 (1%)	56 (1%)	132 (1%)	1111 (11%)
	7	172 (2%)	152 (2%)	157 (2%)	341 (3%)	6 (0%)	137 (1%)	15 (0%)	104 (1%)	1084 (11%)
	8	86 (1%)	132 (1%)	122 (1%)	169 (2%)	6 (0%)	98 (1%)	69 (1%)	66 (1%)	747 (8%)
	TOT	1606 (16%)	1151 (12%)	2151 (22%)	2050 (21%)	82 (1%)	1475 (15%)	552 (6%)	757 (8%)	9824 (100%)

6. Forecasting Results

This chapter summarises the forecasting results, including model summary statistics, change in link and junction flow and locations of congestion.

Forecasting Results

6.1. This chapter provides modelling outputs and results from the MATS forecast year models. The following data has been extracted to show the model performance of the forecast year models and the impacts of the future developments on the March local transport network.

- Model convergence
- Model summary statistics
- Locations of congestion hot spots
- Link flow data for key corridors
- Turning flow data for key junctions
- Journey time data

Model Convergence

6.2. The following convergence criteria have been adopted for the MATS forecast year models. All forecast year met the following criteria and full convergence statistics can be found in Appendix C for reference.

6.3. 'Delta' is the measure of convergence of the final assignment to ensure that alternative routes used in the assignment process do not differ significantly from the final minimum cost. It is the difference between costs on the various multiple assigned routes and those along the final minimum cost routes, as a percentage of the minimum cost routes. Its value should be less than 1%.

6.4. Flow Change Stability (P) is the measure of convergence of assignment-simulation loops. It is the percentage of links where assigned flows change by less than 5% between successive assignment simulation loops. Assignment model iterations should continue until at least four successive values of 'P' greater than 90% have been obtained. For the forecast year MATS models, 'P' value of 95% have been used.

6.5. 'Gap' is the measure of convergence between the final SATASS/SATSIM loop. It is the difference between costs on the assigned routes and those along the minimum cost routes, as a percentage of the cost routes. A value of less than 0.25% is recommended.

Model Assignment Summary Statistics

6.6. The model assignment summary statistics contained within the SATURN model output provide a good overview about the performance of the models. These statistics cover the whole model and can provide a good comparison between the performances of different scenarios, although they do not give detailed information about the performance of individual links and junctions. The statistics that have been extracted and examined are:

- Total Travel Time (pcu-hr);
- Total Travel Distance (pcu-km);
- Average Speed (kph);
- Total Trips Loaded (pcu).

6.7. The model assignment summary statistics for all forecast year models are included in Appendix D.

6.8. Total travel time, total travel distance and total trips loaded increase proportionally with forecast years (and demand) as might be expected. The change in these three statistics is fairly consistent, in that the percentage increase in total trips loaded is similar to total travel time and total travel distance:

- For 2010 to 2016, the total travel time, total travel distance and total trips loaded increase by 10 to 20% for all scenarios;

- For 2010 to 2021, the total travel time, total travel distance and total trips loaded increase by 10 to 20% for all scenarios; and
- For 2010 to 2026, the total travel time, total travel distance and total trips loaded increase by 30 to 40%.

6.9. In general, the average model speed reduces slightly for the forecast year models when compared to the 2010 base year model. The model scenario with the most significant average speed reduction is the 2026 DS2 PM peak where the speed reduces from 60.8 kph in the 2010 base year PM peak model to 56.2 kph in the 2026 DS2 PM peak model. Considering that the matrix size increase by over 40% (see Table 5.4), a reduction of 4.6 kph in average model speed is comparatively small. This suggests that the average speeds are maintained on the March network, demonstrating that in general the current infrastructure is able to accommodate the additional demand in the forecast years, although additional congestions and delays are expected at some junctions and locations which caused the slight reduction in average speed.

Locations of Congestion Hot Spots

Link Volume/Capacity

- 6.10. Figure 6.1 to Figure 6.4 show the links with high Volume/Capacity (V/C) ratio (i.e.>85%) for the PM peak models. These links are operating very close to capacity, and therefore congestions and delays are expected at these locations.
- 6.11. Links with high V/C for AM and inter peak models were also extracted, but as PM peak is the busiest peak hour, the plots for AM and inter peak models are not presented below and have been included in Appendix H only.
- 6.12. As shown in the figures below, the locations of congestion are very similar for all forecast year scenarios. The busiest junctions based on the V/C plots are:
- 1 – B1101 Station Road/B1101 Broad Street/B1099 Dartford Road;
 - 2 – A141/B1099 Wisbech Road;
 - 3 – A141/Hostmoor Avenue;
 - 4 – B1101 High Street/Burrowmoor Road;
 - 5 – B1101 High Street/St Peters Road;
 - 6 – A141/B1101 Wimblington Road;
 - 7 – A141/Gaul Road; and
 - 8 – B1101 Elm Road/Twenty Foot Road.
- 6.13. Link V/C values for all time periods for the above junctions can also be found in Table H.1 to Table H.3 in Appendix H for reference.

Figure 6.1 – Locations of Congestion Hot Spots (2010 Base, PM)



Figure 6.2 – Locations of Congestion Hot Spots (Forecast Year DM Scenarios, PM)

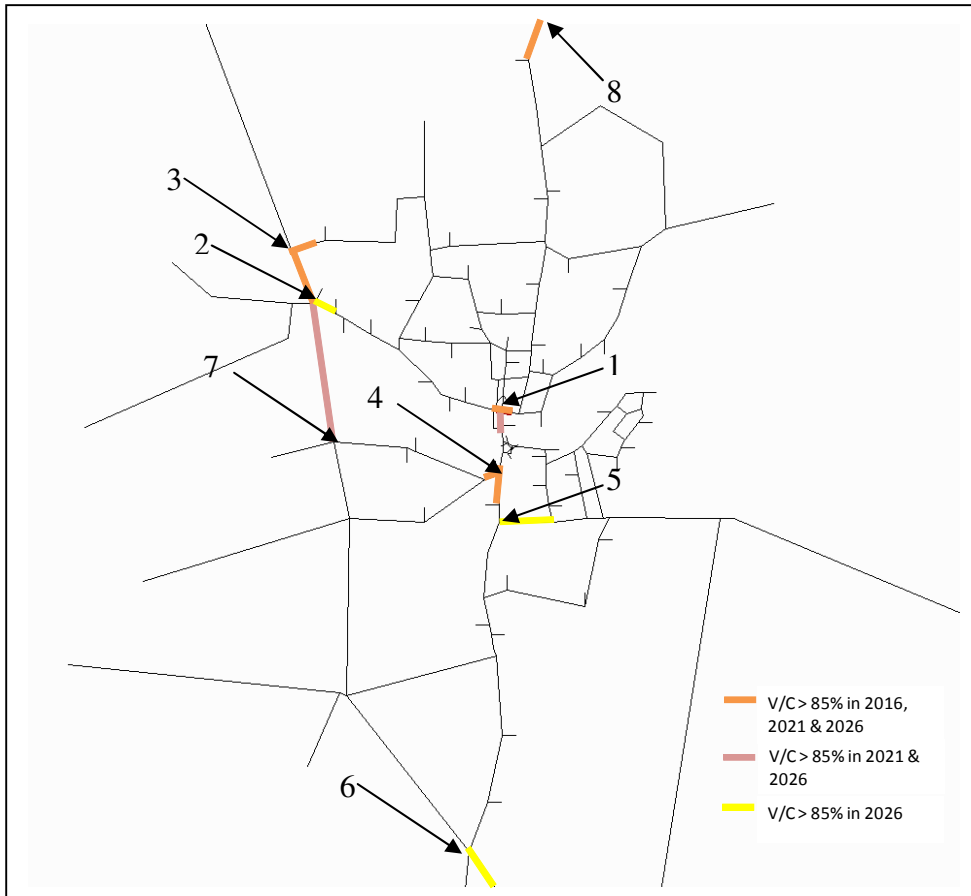

Figure 6.3 – Locations of Congestion Hot Spots (Forecast Year DS1 Scenarios, PM)

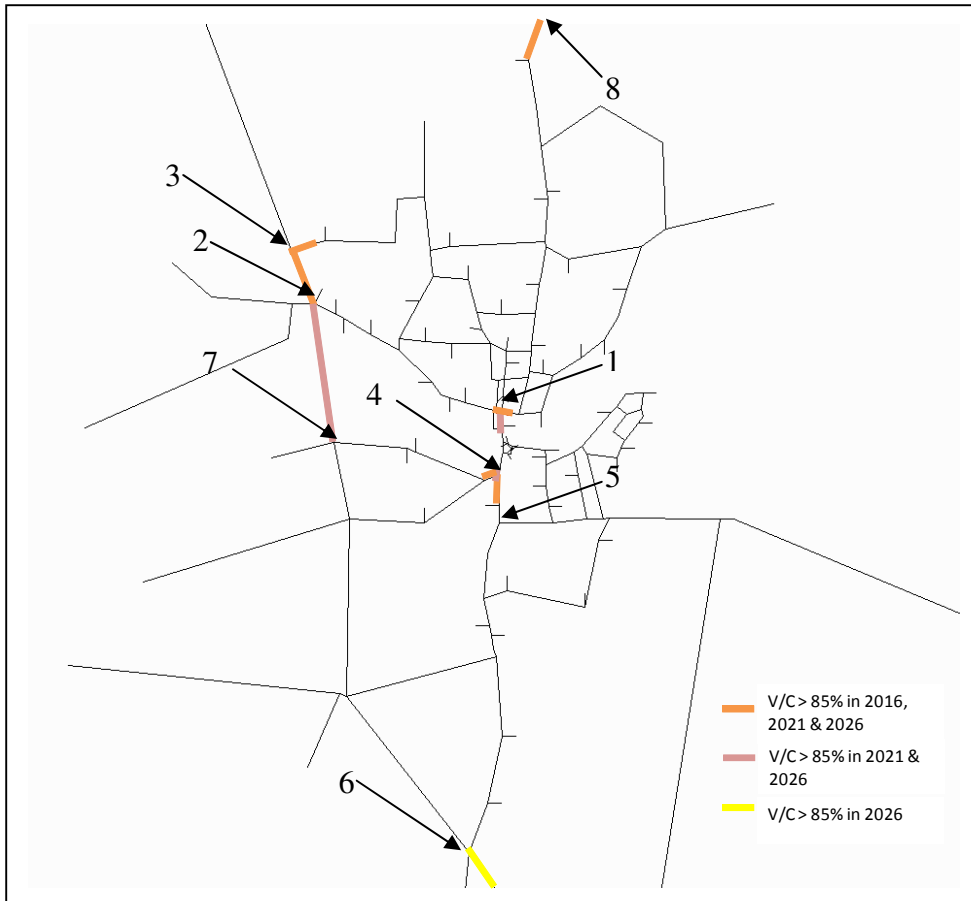
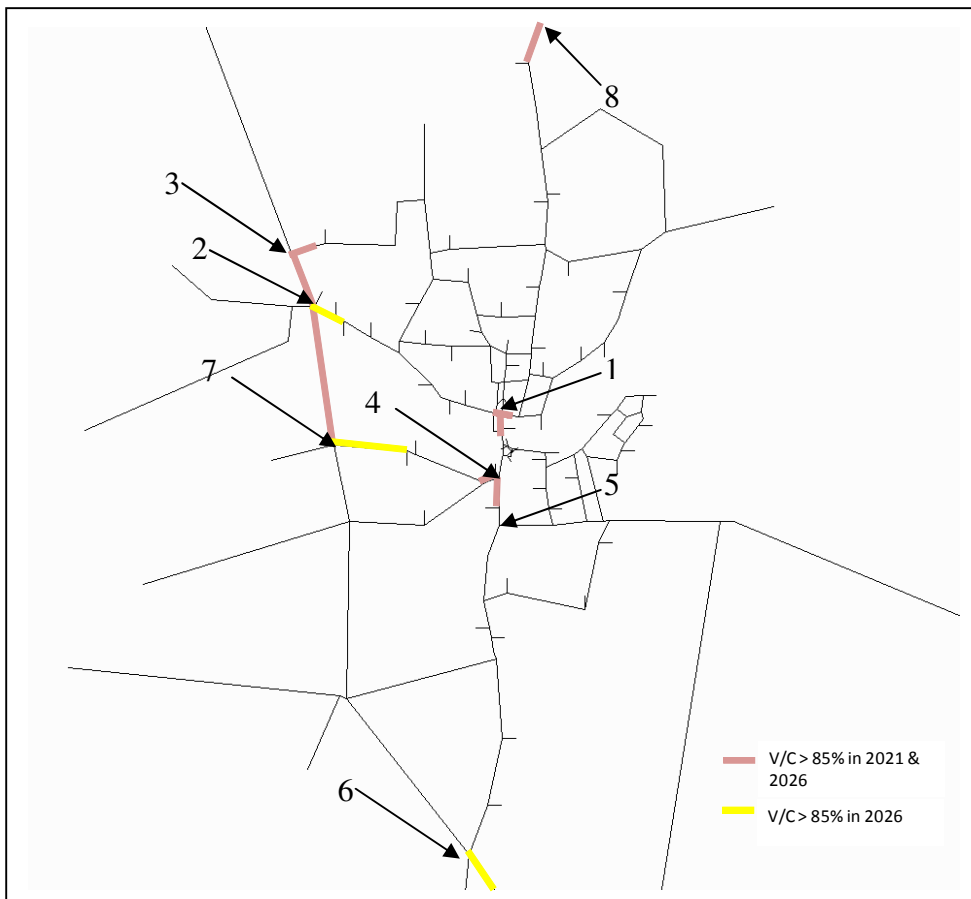

Figure 6.4 – Locations of Congestion Hot Spots (Forecast Year DS2 Scenarios, PM)



- 6.14. Initial observation shows that the links with high V/C are mainly on the B1101 and A141. As these two routes are the main north-south corridors for March, and provide the only two crossing points for River Nene, it is not surprising that these two corridors will see an increase in V/C and delay in the forecast year as demand increases.
- 6.15. Also, as the traffic flow increases on the A141 in the forecast years, it becomes more difficult for the minor road traffic, such as Gaul Road and Burrowmoor Road, to find gaps and join the A141, resulting in higher V/C for the minor road approaches to the A141, particularly in 2026 (See also Appendix E for detailed V/C data). Hostmoor Avenue has significant increase in committed employment developments, as shown in Figure 5.2, which causes additional delay for this link.
- 6.16. Comparison between the DM and DS1 plots (Figure 6.2 & Figure 6.3) show that the V/C for B1099 St Peters Road is over 85% in the DM scenario but not in the DS1 scenario for 2026. Although the total model demand level for these two scenarios are both controlled to the same level (i.e. TEMPRO 6.1), the distribution is different. For DM, there are no large development sites and the increase in demand is more evenly distributed throughout March; whereas for DS1, SFF Opportunity Zone 1a and 1b (situated in the north and west of March) are the major development sites and there are significant increases in demand to/from these sites.
- 6.17. The flow difference plots between DS1 and DM scenario for 2026 PM peak (Figure F.21) shows the impact of different demand distribution on link flows and that the flow for the B1099 St Peters Road approach to the junction is lower in the DS1 scenario when compared to the DM, resulting in less delay for the B1099 St Peters Road in the DS1 scenario. Although the signal optimisation process, SIGOPT (See Paragraph 4.6), has been used to adjust the signal timing at this junction in response to the change in demand on the approaches to the junction, the delay for the B1099 St Peters Road is still marginally greater in DM than the DS1 scenario. Figure 6.5 and Figure 6.6 below show the junction arrive flow and signal timings from the 2026 DM and DS1 PM peak model respectively.

Figure 6.5 – B1101 High Street/B1099 St Peters Road Junction (2026 DM, PM)

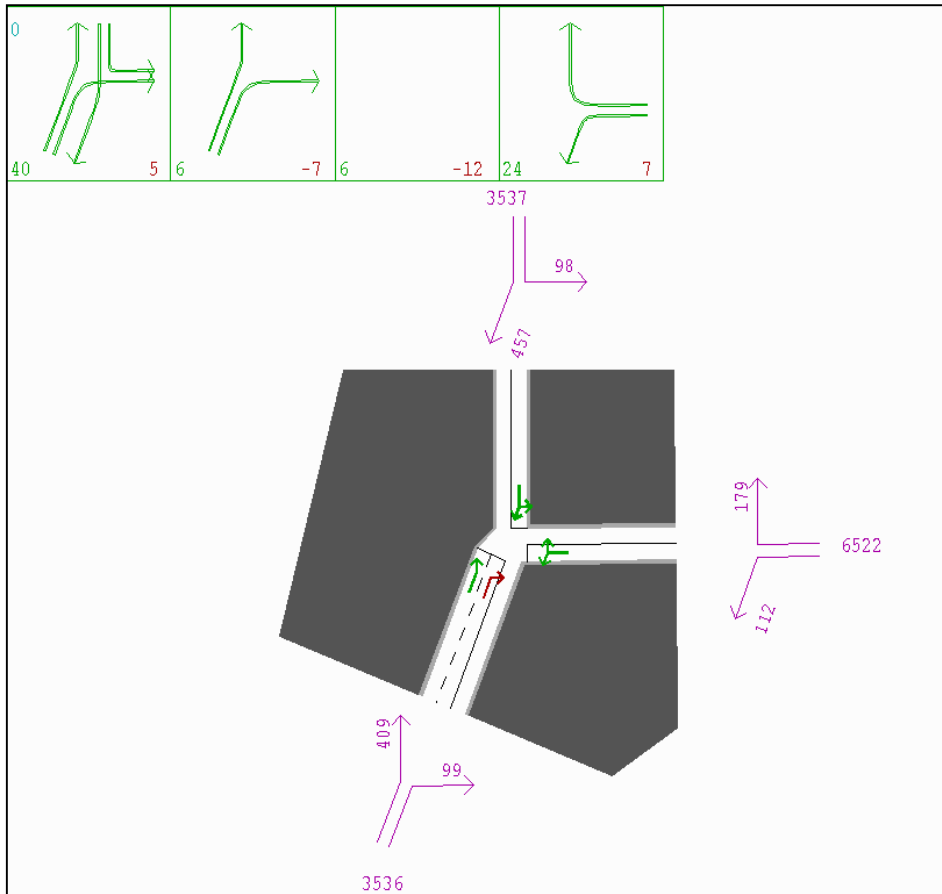
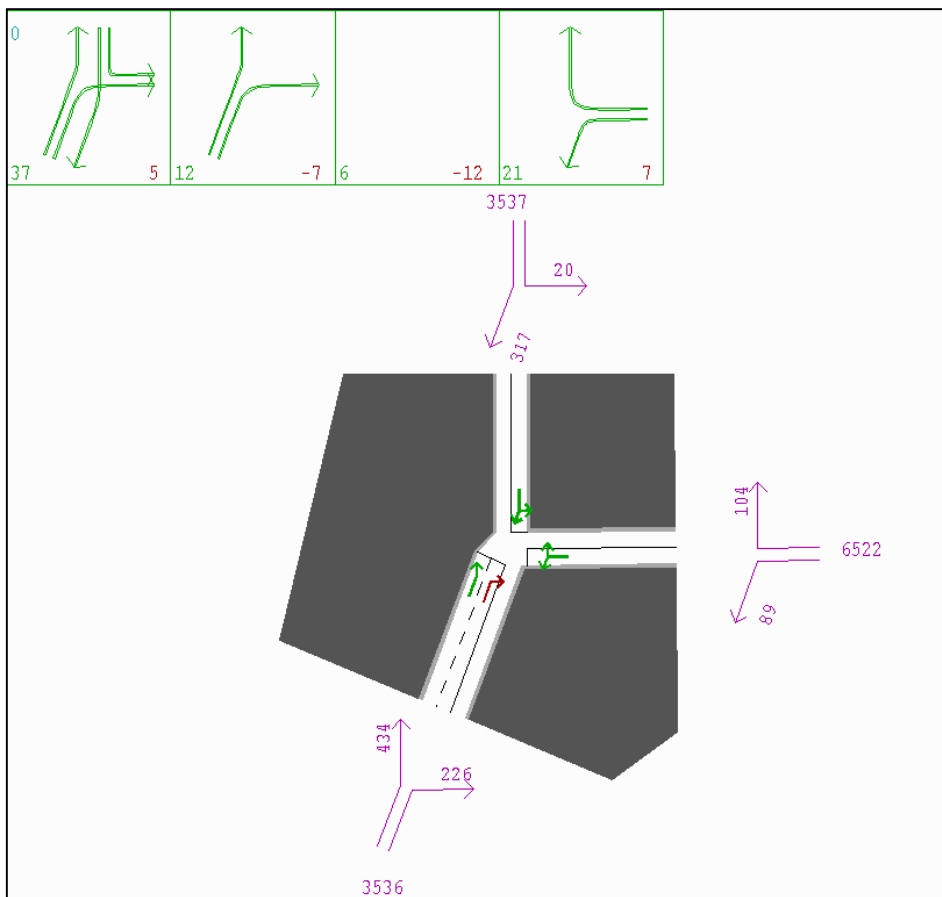

Figure 6.6 – B1101 High Street/B1099 St Peters Road Junction (2026 DS1, PM)



6.18. The above paragraphs have been focused on the performance of the PM peak network. For the AM peak, all the links and junctions highlighted above as operating at or over capacity (i.e. V/C >85%) in the PM peak are also busy in the AM peak, but with marginally lower V/C ratio. The only *exceptions* are:

- 5 – B1101 High Street/St Peters Road;
- 6 – A141/B1101 Wimblington Road; and
- 8 – B1101 Elm Road/Twenty Foot Road

which all approach arms to these junctions are operating at under 85% link V/C in the AM peak.

6.19. For the inter peak, the network is much quieter and only four junctions have one or more approaches with link V/C at or greater than 85%. These junctions are:

- 1 – B1101 Station Road/B1101 Broad Street/B1099 Dartford Road;
- 2 – A141/B1099 Wisbech Road;
- 3 – A141/Hostmoor Avenue; and
- 4 – B1101 High Street/Burrowmoor Road.

Junction Volume/Capacity

6.20. Junction V/C is the flow weighted V/C for all turning movements at the junction. Figure 6.7 to Figure 6.10 show the junction V/C for the PM peak models (Larger version of the junction V/C figures can be found in Appendix H for reference). Again, only PM peak data is shown below as it is the busiest peak hour, and junction V/C figures for the AM and inter peak are included in Appendix H for information. For the busiest junctions, the V/C and junction delay values for all modelled scenarios have been extracted and presented in Table H.4 in Appendix H for reference and comparison.

6.21. The junction V/C figures highlight the junctions that are busy and operating close to capacity. Green nodes (V/C < 75%) indicate that the junction is operating under capacity and there is no capacity issue at the junction. Amber nodes (75% < V/C < 85%) indicate that the junction is busy and some queuing can be expected. Red nodes (V/C > 85%) indicate that the junction is very close to or over capacity and significant queuing and delay can be expected.

6.22. Figure 6.7 shows that for the 2010 base year, most junctions within the network are operating under capacity and are generally free-flowing. The two busiest junctions, with amber status, are in the centre of March:

- B1101 High Street/Burrowmoor Road; and
- B1101 Station Road/B1101 Broad Street/B1099 Dartford Road.

6.23. These two junctions change to red status in 2016 DM and DS1 scenario as traffic flow increases for the centre of March. In addition, the 2016 models also show that the A141/Hostmoor Avenue will be very busy due increase in demand for this junction to/from the committed development (See Figure 5.2). For the 2016 DM PM peak model, the A141/Hostmoor Avenue junction is in amber status; and for the 2016 DS1 PM peak model, the junction is in red status. To summarise, the busiest junctions in 2016 PM peak are:

- B1101 High Street/Burrowmoor Road;
- B1101 Station Road/B1101 Broad Street/B1099 Dartford Road; and
- A141/Hostmoor Avenue.

6.24. For 2021 PM peak, all modelled scenarios (i.e. DM, DS1 and DS2) shows the same trend that the following junctions are in red status whilst the rest of the junctions in the network are in green status:

- B1101 High Street/Burrowmoor Road;
- B1101 Station Road/B1101 Broad Street/B1099 Dartford Road; and
- A141/Hostmoor Avenue.

6.25. For all 2026 modelled scenarios, the three red status junctions in 2021 continue to remain red as might be expected. For 2026 DM and DS1 PM peak, A141/B1099 Wisbech Road roundabout changes to amber status; and for 2026 DS2 PM peak, two additional junctions along the A141 (A141/Gaul Road and A141/Burrowmoor Road) change to amber status. To summarise, the junctions with over 75% V/C in 2026 PM peak include:

- B1101 High Street/Burrowmoor Road;
- B1101 Station Road/B1101 Broad Street/B1099 Dartford Road;
- A141/Hostmoor Avenue;
- A141/B1099 Wisbech Road roundabout;
- A141/Gaul Road (2026 DS2 PM peak only); and
- A141/Burrowmoor Road (2026 DS2 PM peak only).

6.26. The junctions with high V/C values in the PM peak, as highlighted above, are generally busy in the AM peak but with marginally lower V/C values for all modelled forecast years and scenarios. For the inter peak, only the following junctions have been highlighted as busy:

- B1101 High Street/Burrowmoor Road;
- B1101 Station Road/B1101 Broad Street/B1099 Dartford Road; and
- A141/Hostmoor Avenue.

A141/B1099 Wisbech Road Roundabout

6.27. It should be noted that for junctions with a mixture of busy and quiet approaches, the junction V/C might not be a good indication of the performance of the junction as it is the average V/C of all approach arms. For example, for A141/B1099 Wisbech Road roundabout which is a 5-arm roundabout, two of the approach arms are minor approaches with very low demand (i.e. Retail access and Whittlesey Road). The junction V/C plots below show that this junction only turn to amber status in 2026 which seems to suggest that this junction is operating under capacity prior to 2026. However, when analysing the link V/C by approach arm, the A141 (N) and A141 (S) approaches are operating at over 75% (link V/C) for 2016 PM peak which continues to increase for subsequent forecast years. For 2026 PM peak, A141 (N), A141 (S) and B1099 Wisbech Road approaches are all operating at over 75% link V/C for all scenarios (See Figure 6.2 to Figure 6.4 and Table H.3 for link V/C data).

Figure 6.7 – Junction V/C (2010, PM)

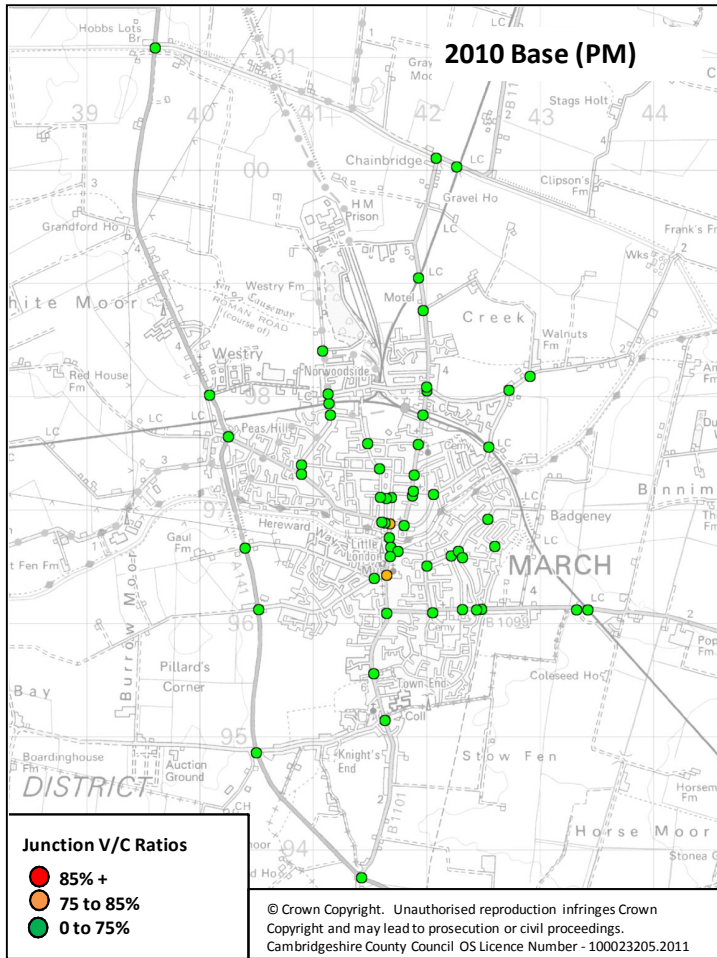

Figure 6.8 – Junction V/C (2016, PM)

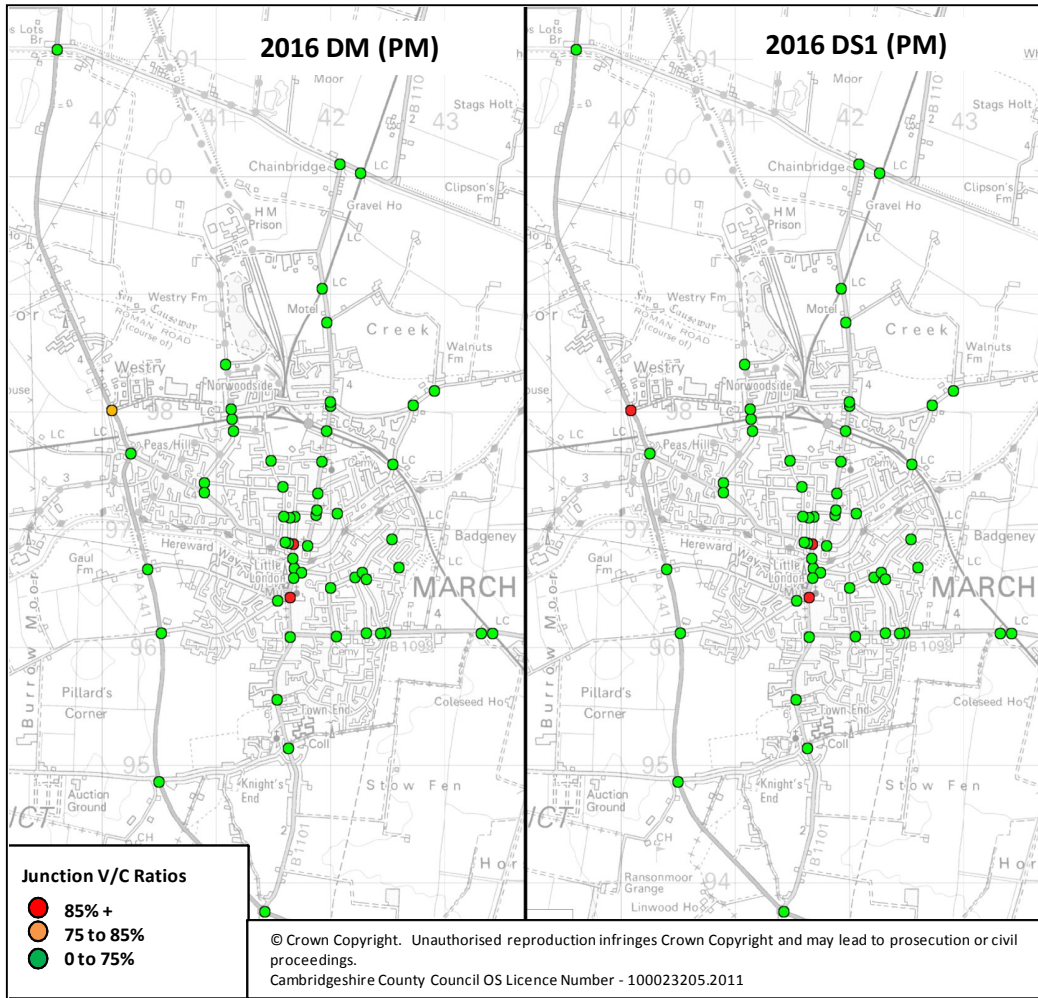

Figure 6.9 – Junction V/C (2021, PM)

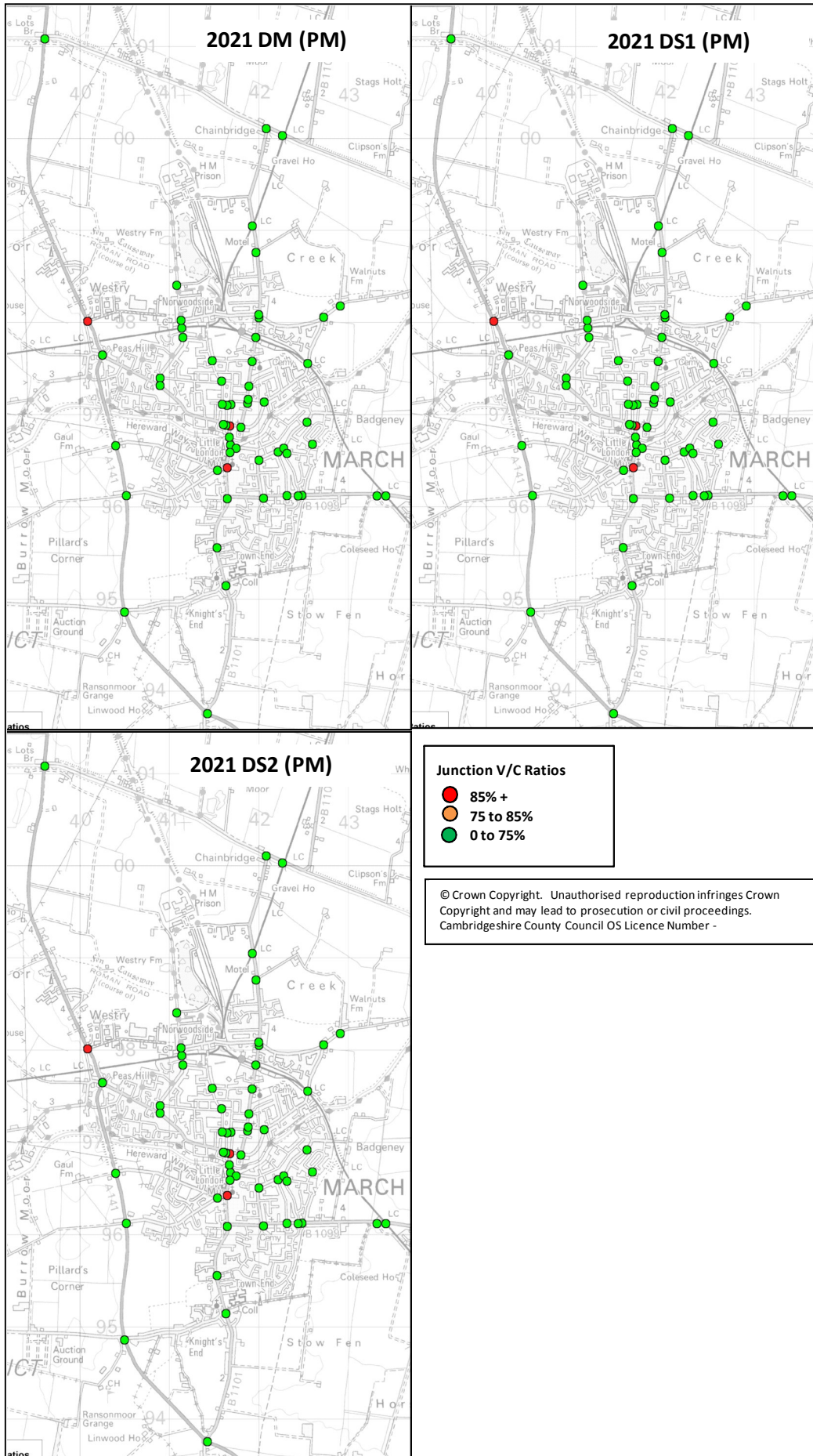
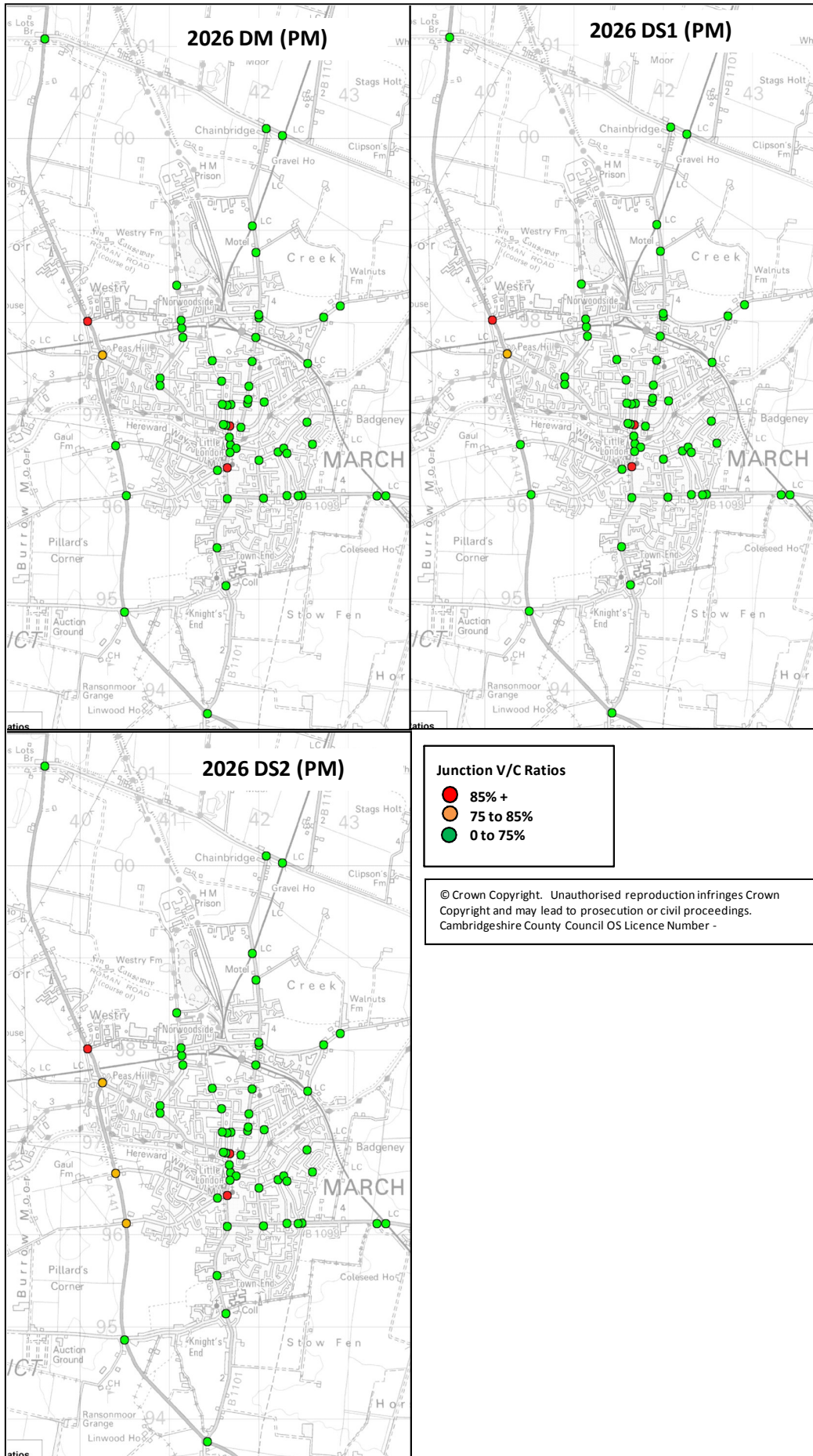

Figure 6.10 – Junction V/C (2026, PM)



Summary

- 6.28. The link and junction V/C plots show the busiest junctions within the March network as well as provide an indication of whether the junctions can accommodate the demand and the operational performance of the junctions in the forecast years.
- 6.29. Both link and junction V/C plots show the congestion hot spots within the March network and how these change over time. The results from both link and junction V/C plots are generally consistent and Table 6.1 below summarises the congestion hot spots for all modelled scenarios.

Table 6.1 – Congestion Hot Spots Summary

Description	2010 Base	2016 DM	2016 DS1	2021 DM	2021 DS1	2021 DS2	2026 DM	2026 DS1	2026 DS2
AM									
B1101 Station Road/B1101 Broad Street/B1099 Dartford Road		●	●	●	●	●	●	●	●
A141/B1099 Wisbech Road				●	●	●	●	●	●
A141/Hostmoor Avenue		●	●	●	●	●	●	●	●
B1101 High Street/Burrowmoor Road		●	●	●	●	●	●	●	●
B1101 High Street/St Peters Road									
A141/B1101 Wimblington Road									
A141/Gaul Road							●	●	●
B1101 Elm Road/Twenty Foot Road									
A141/Burrowmoor Road		●	●	●	●	●	●	●	●
IP									
B1101 Station Road/B1101 Broad Street/B1099 Dartford Road				●	●	●	●	●	●
A141/B1099 Wisbech Road							●	●	●
A141/Hostmoor Avenue				●	●	●	●	●	●
B1101 High Street/Burrowmoor Road					●	●	●	●	●
B1101 High Street/St Peters Road									
A141/B1101 Wimblington Road									
A141/Gaul Road									
B1101 Elm Road/Twenty Foot Road									
A141/Burrowmoor Road				●	●	●	●	●	●
PM									
B1101 Station Road/B1101 Broad Street/B1099 Dartford Road	●	●	●	●	●	●	●	●	●
A141/B1099 Wisbech Road		●	●	●	●	●	●	●	●
A141/Hostmoor Avenue		●	●	●	●	●	●	●	●
B1101 High Street/Burrowmoor Road		●	●	●	●	●	●	●	●
B1101 High Street/St Peters Road							●		
A141/B1101 Wimblington Road							●	●	●
A141/Gaul Road									●
B1101 Elm Road/Twenty Foot Road		●	●	●	●	●	●	●	●
A141/Burrowmoor Road	●	●	●	●	●	●	●	●	●

- 6.30. To further understand the cause of these congestion hot spots, modelled data for key corridors and junctions are extracted; and the changes in traffic flow volume and pattern were investigated. These are discussed in the sections below.

Link Flow Data for Key Corridors

- 6.31. 42 key links have been identified, as shown in Figure 6.11 (The numbers shown in the figure represent the link IDs). Modelled data, including flow, V/C and delay, have been extracted for these 42 key links, which can be found in Appendix E.
- 6.32. These key links include all the key radial routes as identified previously when processing the traffic flow data (See Figure 4.2, MATS Data Collection Report), as well as other links which have been identified as congestion hot spots and links which are located in close proximity to the SFF Opportunity Zones.
- 6.33. Flow difference plots, which shows the change in link flow between the 2010 base and forecast year DM scenarios; DM and DS1 scenarios; and DS2 and DS1 scenarios have also been extracted for all forecast years and time periods and included in Appendix F for reference.

Figure 6.11 – Key Links

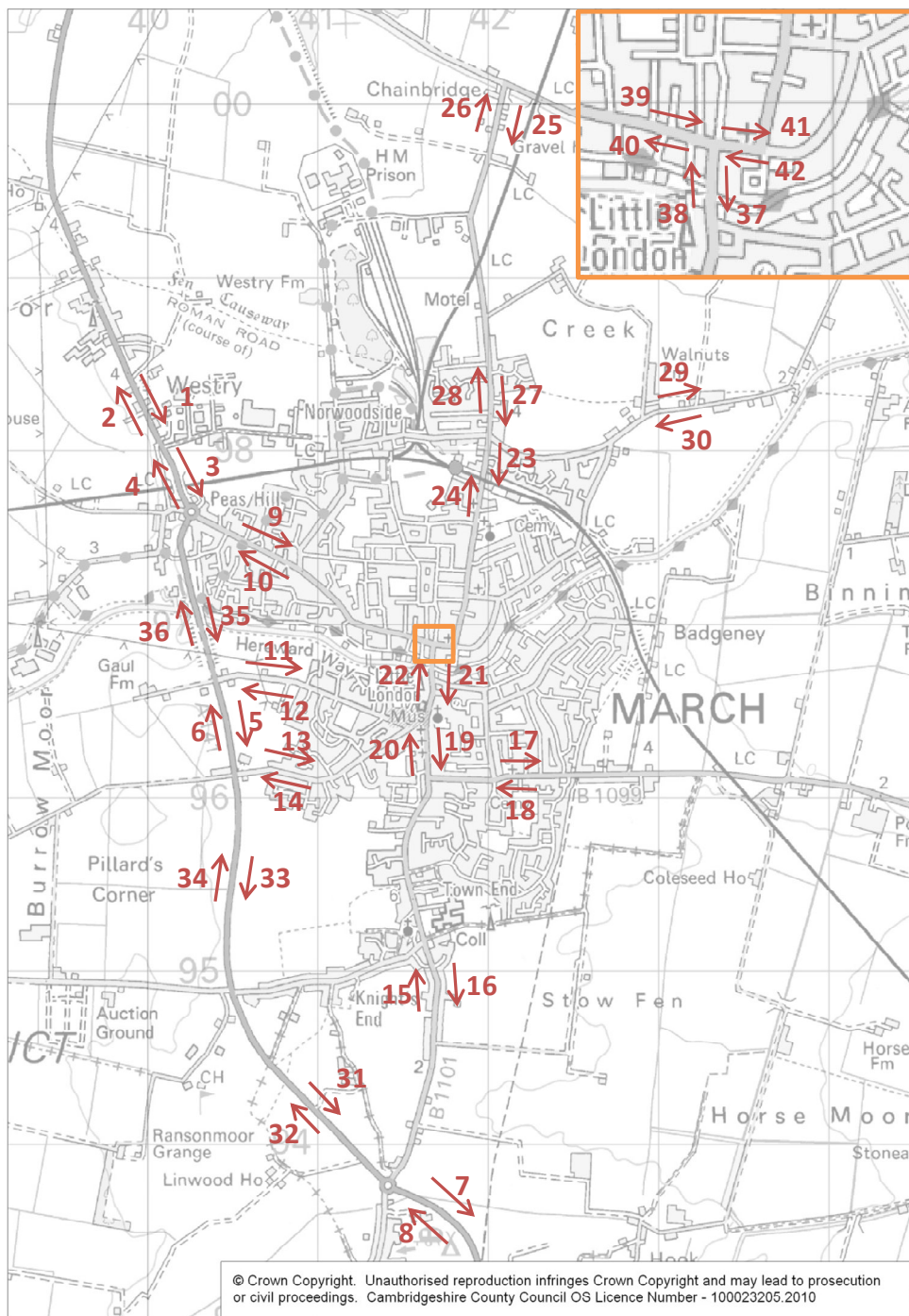

- 6.34. The following paragraphs discuss the changes in flow for the congestion hot spots identified in previous paragraphs.
- 6.35. From the congestion hot spots figures, it is evident that the busiest and most congested movement for the March network in the forecast years is the north-south movements on the A141 and B1101. Table 6.2 shows the two-way traffic flow data for the B1101 High Street (i.e. Link 21 & 22) and A141 Isle of Ely Way (i.e. Link 5 & 6) for all forecast years, scenarios and time periods.
- 6.36. The combined B1101 and A141 data shows that the traffic flows for the north-south movement increases steadily over the years as might be expected.
- 6.37. Comparison between the DM and DS1 scenarios shows that the traffic flows on the B1101 and A141 are higher in the DS1 than DM for all modelled forecast years. As SFF Opportunity Zone 1b is located between the A141 and B1101, this is not surprising.
- 6.38. Similarly, comparison between the DS1 and DS2 in general shows that the flows on the B1101 and A141 are higher in the DS2 than DS1 scenario with the exception of B1101 2026 PM peak. SFF Opportunity Zone 2a is located between the A141 and B1101, with the access for Opportunity Zone 2b being via the B1101, flow increases for these two corridors are expected.
- 6.39. Figure 6.12 to Figure 6.14 below shows the traffic growth profile for the B1101 and the A141 for AM, inter and PM peak respectively. These figures show for the AM and PM peaks that the level of traffic using the B1101 through March town centre remain consistent between 2021 and 2026, suggesting that the B1101 High Street reaches its capacity in 2021 and the north-south traffic movement therefore prefers the A141 post 2021 as traffic levels continue to increase for the A141 between 2021 and 2026. The inter peak shows a steady increase in traffic levels through to 2026.

Table 6.2 – Traffic Flow Data (pcu) for B1101 High Street and A141 Isle of Ely Way

	B1101 High Street			A141 Isle of Ely Way			B1101 & A141 Total		
	AM	IP	PM	AM	IP	PM	AM	IP	PM
2010 Base	1,034	827	1,047	1,480	1,106	1,529	2,514	1,934	2,577
2016 DM	1,309	962	1,270	1,764	1,270	1,865	3,073	2,232	3,135
2021 DM	1,364	1,087	1,324	1,961	1,393	2,061	3,325	2,480	3,385
2026 DM	1,465	1,251	1,382	2,158	1,547	2,274	3,623	2,798	3,656
2016 DS1	1,380	1,028	1,325	1,857	1,311	1,925	3,237	2,339	3,250
2021 DS1	1,561	1,316	1,579	2,200	1,467	2,181	3,761	2,783	3,760
2026 DS1	1,588	1,505	1,598	2,558	1,748	2,545	4,146	3,253	4,143
2021 DS2	1,565	1,322	1,565	2,209	1,468	2,207	3,774	2,790	3,772
2026 DS2	1,590	1,549	1,593	2,655	1,822	2,658	4,245	3,371	4,251

Figure 6.12 – Traffic Growth Profile for B1101 and A141 (AM)

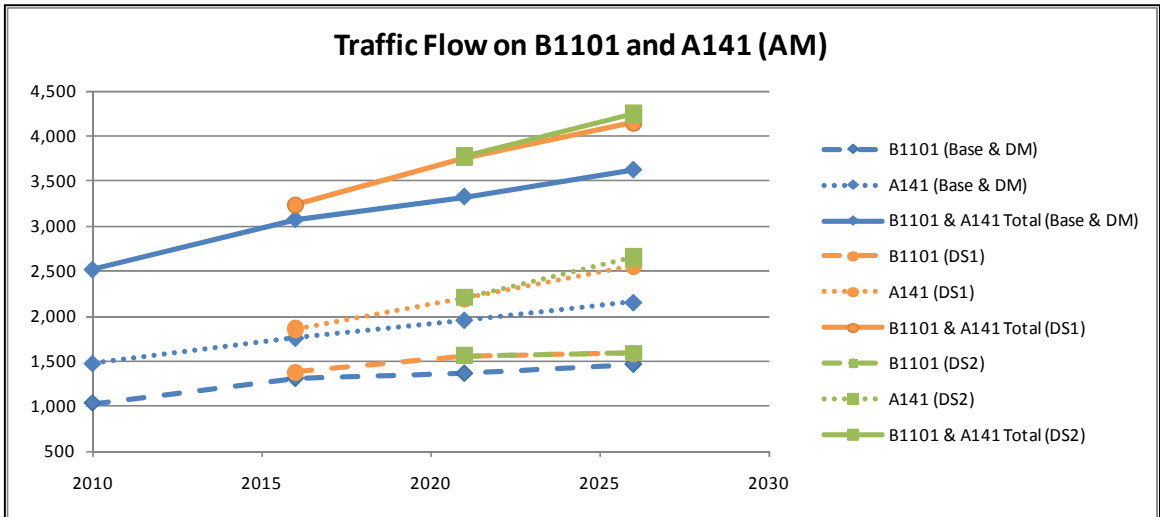

Figure 6.13 – Traffic Growth Profile for B1101 and A141 (IP)

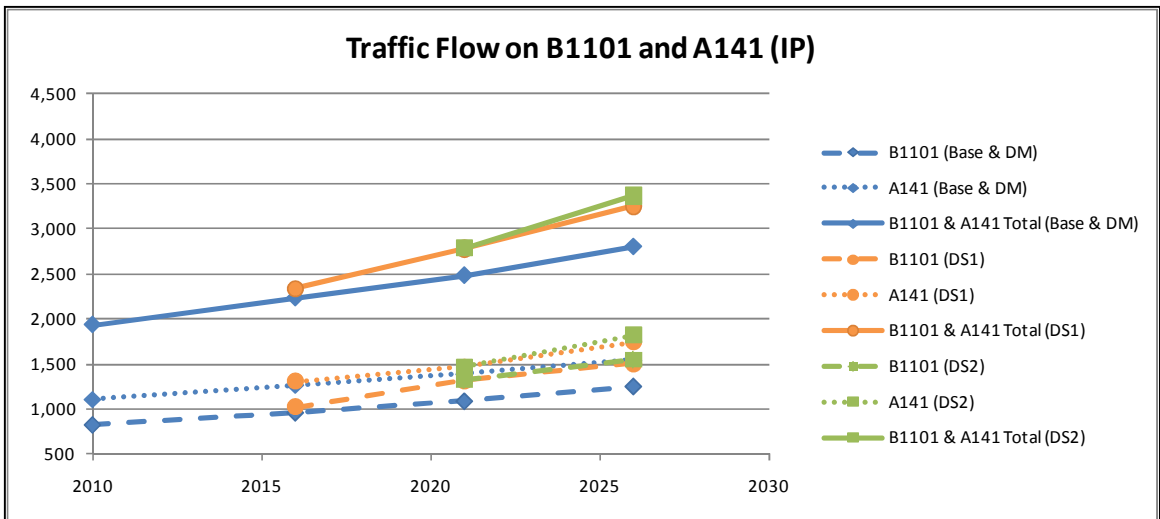
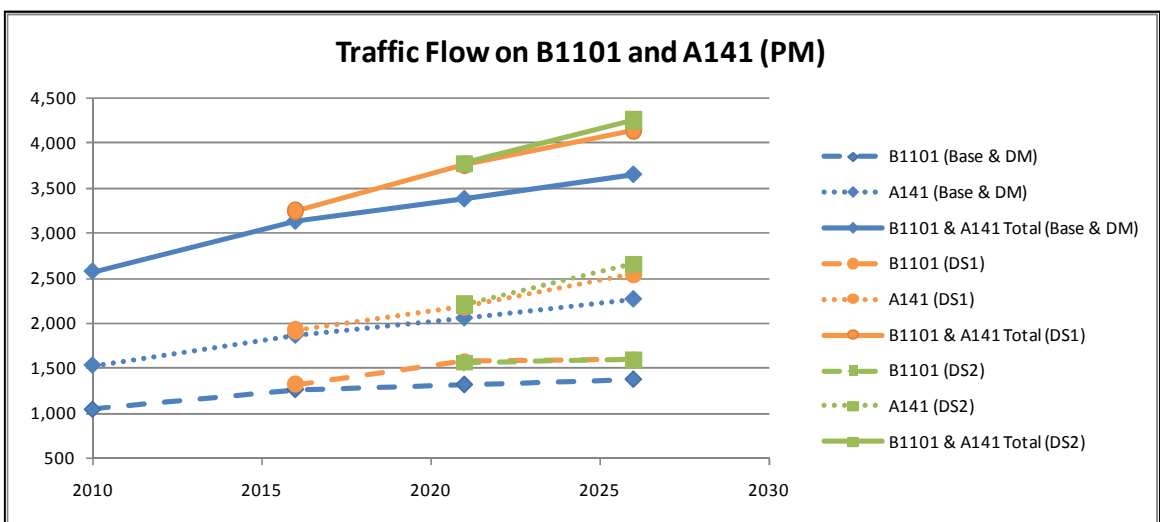

Figure 6.14 – Traffic Growth Profile for B1101 and A141 (PM)



Routing Analysis

- 6.40. Select Link Analysis was undertaken for the B1101 and A141 to gain further understanding of the trips that use these corridors (i.e. the key north-south corridors for the March network). Select Link Analysis provides information on the origin/destination and routing of the trips that use a specific link. It is a useful tool to check if and how the natures of trips using a specific link change in the forecast years.
- 6.41. Figure 6.15 and Figure 6.16 shows the Select Link Analysis routing plots for the B1101 and A141 for the 2010 base year PM peak model. The Select Link Analysis was undertaken by direction, the figure on the left is for southbound and the figure on the right is for northbound. Figure 6.17 to Figure 6.20 show the equivalent Select Link Analysis routing plots for the 2026 DM PM peak model and 2026 DS2 PM peak model. The following plots have been included in this report because they show the routing change for the B1101 and A141 most clearly.
- 6.42. As discussed previously, as the traffic demand for the north-south movement increases in the forecast year, the B1101 becomes more congested and more vehicles choose to use the A141. Comparison between Figure 6.16 and Figure 6.18 shows that in 2026, there is more northbound traffic using the A141 to travel to the north of March (B1101 Elm Road via Norwood Road) than in 2010 (movement marked on Figure 6.18).
- 6.43. Comparison between Figure 6.17 and Figure 6.19 shows that there are more traffic to/from the SFF Opportunity Zones using the B1101 as might be expected. As the capacity of the B1101 is being filled by the Opportunity Zone traffic, the A141 becomes more attractive for other movements, such as from B1099 Upwell Road to north and also traffic to/from B1101 Elm Road (movements marked on Figure 6.20).

Figure 6.15 – Select Link Analysis (B1101) (2010 Base, PM)



Figure 6.16 – Select Link Analysis (A141) (2010 Base, PM)

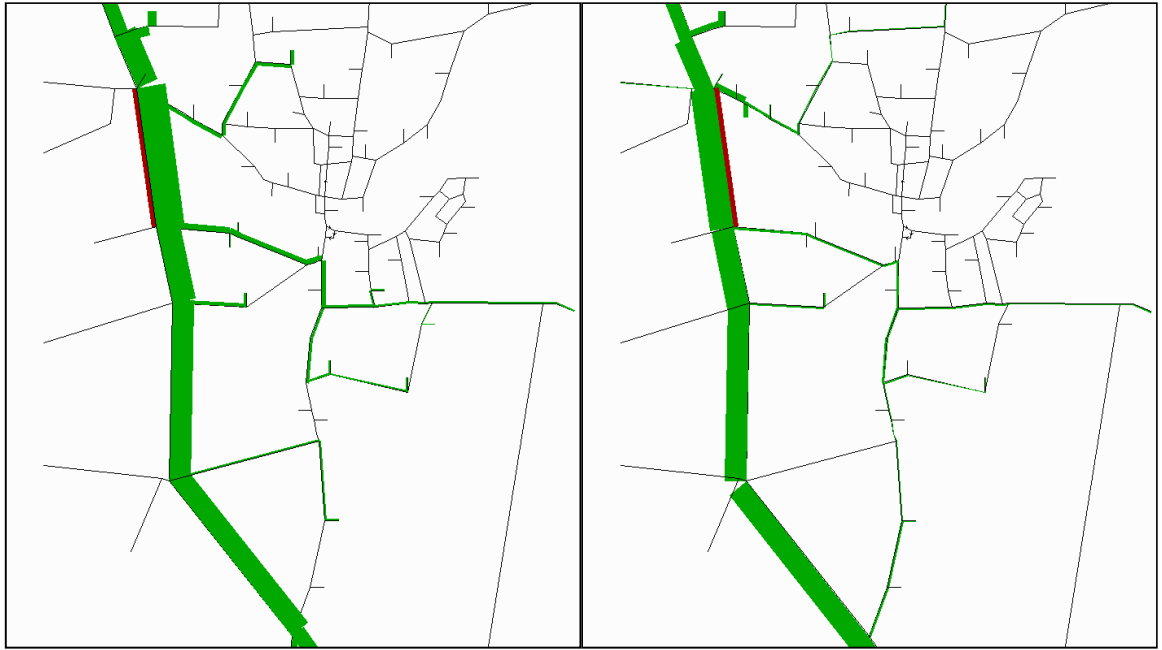

Figure 6.17 – Select Link Analysis (B1101) (2026 DM, PM)

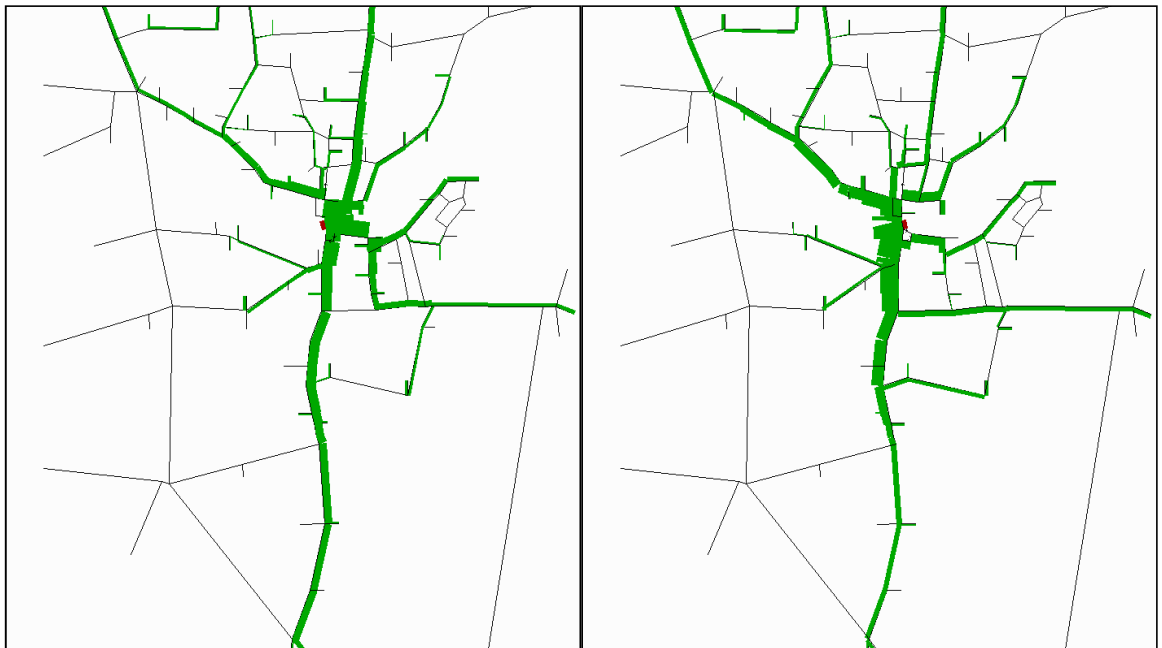

Figure 6.18 – Select Link Analysis (A141) (2026 DM, PM)



Figure 6.19 – Select Link Analysis (B1101) (2026 DS2, PM)

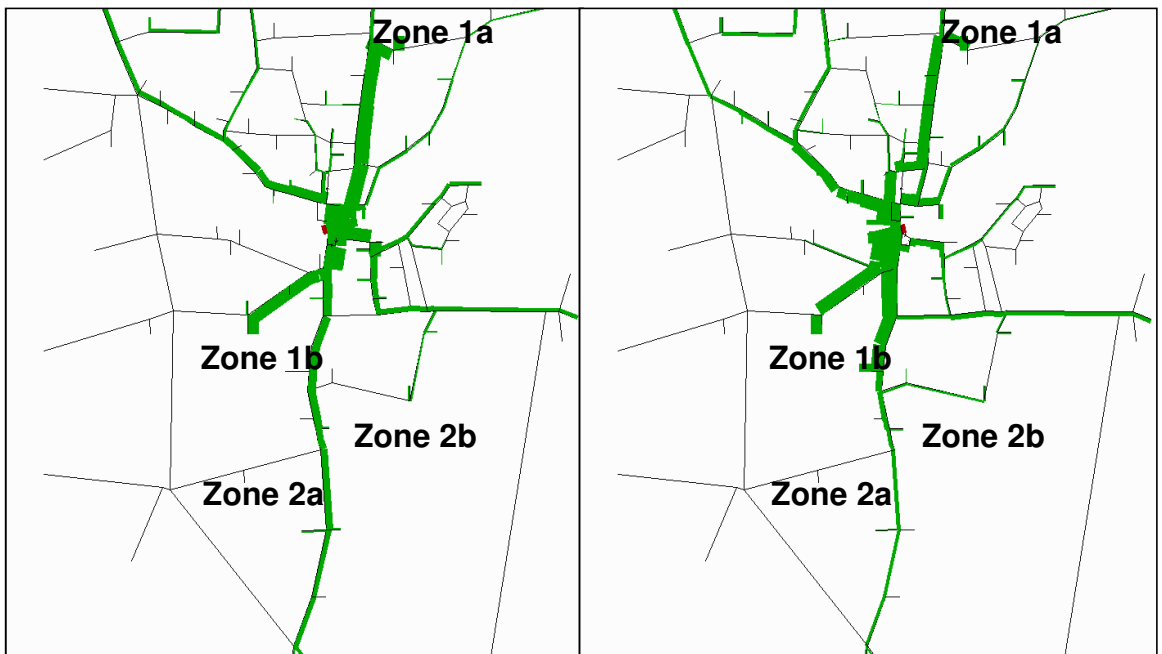

Table 6.3 – AADT/CRF Ratio for Key Links (See Figure 6.11 for Key Link Locations)

LinkID	2010 Base	2016 DM	2016 DS1	2021 DM	2021 DS1	2021 DS2	2026 DM	2026 DS1	2026 DS2
1	43%	47%	47%	50%	51%	51%	53%	54%	54%
2	45%	46%	46%	49%	49%	49%	51%	51%	51%
3	27%	31%	31%	31%	31%	31%	31%	32%	32%
4	56%	67%	67%	70%	69%	69%	72%	71%	70%
5	39%	48%	51%	53%	63%	63%	58%	73%	75%
6	38%	47%	49%	53%	56%	56%	59%	65%	67%
7	44%	50%	50%	54%	53%	53%	58%	56%	56%
8	47%	53%	52%	57%	56%	56%	61%	60%	61%
9	26%	32%	26%	36%	30%	31%	42%	41%	42%
10	42%	49%	44%	52%	47%	48%	60%	53%	56%
11	14%	16%	11%	17%	9%	9%	18%	5%	5%
12	8%	8%	7%	8%	7%	7%	9%	6%	6%
13	11%	14%	14%	16%	15%	15%	18%	20%	21%
14	7%	7%	7%	7%	7%	7%	7%	8%	7%
15	34%	35%	31%	35%	31%	31%	36%	29%	31%
16	38%	40%	37%	43%	35%	37%	43%	36%	40%
17	16%	16%	14%	18%	14%	14%	20%	15%	16%
18	12%	14%	14%	16%	15%	15%	17%	17%	17%
19	36%	41%	35%	41%	29%	29%	40%	24%	23%
20	35%	42%	39%	44%	39%	39%	46%	39%	39%
21	34%	40%	45%	42%	52%	52%	44%	54%	54%
22	44%	57%	56%	60%	64%	64%	64%	64%	64%
23	25%	29%	33%	31%	43%	43%	34%	51%	49%
24	19%	24%	30%	24%	42%	42%	27%	51%	51%
25	22%	29%	28%	31%	28%	28%	34%	30%	30%
26	23%	32%	32%	34%	34%	34%	35%	35%	35%
27	29%	35%	32%	38%	31%	31%	42%	32%	32%
28	24%	35%	32%	37%	32%	32%	38%	32%	32%
29	4%	5%	5%	5%	5%	5%	6%	6%	6%
30	4%	5%	5%	5%	5%	5%	6%	6%	7%
31	33%	39%	40%	42%	47%	47%	46%	55%	55%
32	39%	48%	48%	53%	55%	56%	60%	64%	66%
33	38%	46%	47%	50%	55%	55%	55%	63%	65%
34	39%	48%	48%	53%	55%	56%	60%	64%	67%
35	45%	53%	54%	57%	62%	62%	61%	72%	74%
36	40%	47%	49%	53%	56%	56%	58%	66%	68%
37	51%	59%	59%	63%	67%	67%	68%	69%	69%
38	16%	19%	17%	18%	18%	18%	19%	18%	18%
39	24%	24%	24%	25%	25%	25%	26%	26%	26%
40	31%	36%	33%	37%	33%	33%	36%	32%	31%
41	28%	27%	30%	29%	29%	31%	31%	25%	25%
42	37%	40%	41%	44%	44%	45%	44%	48%	49%

Turning Flow Data for Key Junctions

6.48. Turning flow data was extracted from the models for the junctions located in close proximity to the congestion hot spots, as identified in Paragraph 6.12, and the following junctions, which are located in close proximity to the SFF Opportunity Zones:

- B1101 Elm Road/Estover Road/Norwood Road;
- B1101 Wimblington Road/Jobs Lane;
- A141/Burrowmoor Road; and
- A141/Gaul Road.

6.49. Figure 6.23 (on Page 58) shows the location of the key junctions, and Table 6.4 to Table 6.6 (on Page 59 to 61) shows the total traffic flow through the junctions for all models. For the flow comparison between the DS1 and DM scenarios and between DS2 and DS1 scenario of relevant forecast years, all junctions with flow change greater than +5% have been highlighted in bold.

DM vs 2010 Base

6.50. Comparison between the forecast year DM scenario and the 2010 base shows that the junction with the greatest percentage increase in total junction flow is B1101 Elm Road/Twenty Foot Road junction. This junction is relatively free-flowing in the 2010 base, but as the A141 becomes busier in the forecast year, the minor country route becomes a more attractive route to travel northbound toward Wisbech for the traffic originating from the northern part of March. Although the absolute increase for this junction is not significant, the V/C and delay data (See congestion hot spot plots (Figure 6.1 to Figure 6.4) and link data (Appendix E)), shows that the northbound arm approach to this junction will have difficulties in accommodating the additional demand. The B1101 Elm Road/Estover Road/Norwood Road junction also shows significant percentage increase in the forecast year as a result of more traffic using this minor country route.

6.51. As might be expected, all junctions on the A141 show an increase in total junction flows as traffic flow on the A141 increases. The percentage increase for 2026 DM when compared to 2010 base for the southern A141 roundabout (A141/B1101 Wimblington Road) is 27% to 34% for all time periods; and for the northern A141 roundabout (A141/B1099 Wisbech Road) is 33% to 37% for all time periods.

6.52. For the junctions on the B1101 along the High Street, there are also increases in total junction flows, although generally not as significant as the junctions on the A141.

6.53. The following bullet points list the junctions that are predicted to have the greatest percentage increase in total junction flow between the DM scenario and 2010 base. The trend is consistent between the all modelled forecast years and time periods.

- A141/Burrowmoor Road;
- B1101 Elm Road/Estover Road/Norwood Road; and
- B1101 Elm Road/Twenty Foot Road.

DS1 vs DM

6.54. As discussed in previous chapters, the total demand for DM and DS1 scenarios are the same but with different distribution (See Chapter 3 for Forecast Year Scenario Definitions). Therefore, it is expected that for some of the junctions, the total flow will increase whilst for others, it may decrease.

6.55. B1101 Elm Road/Estover Road/Norwood Road junction which is in close proximity to SFF Opportunity Zone 1a shows an increase in total junction flow as might be expected. Analysis shows that majority of development traffic from Zone 1a enters the network via Estover Road and the increase in flow for this junction is mainly due to the development traffic.

6.56. For B1101 High Street/Burrowmoor Road junction which is in close proximity to Zone 1b, the total junction flow remains fairly consistent between the DS1 and DM scenario. Although there is more traffic travelling to the junction from the Burrowmoor Road approach due to the developments for Zone 1b, there is a reduction in flow from B1101 High Street southern approach, resulting in negligible change in total junction flow for this junction.

Figure 6.23 – Key Junctions



Table 6.4 – Total Junction Flow (2016)

ID	Description	2010 Base	2026 DM	DM vs Base	2026 DS1	DS1 vs DM *
AM						
1	A141/Hostmoor Ave	2,124	2,558	20%	2,554	0%
2	A141/B1099 Wisbech Rd	2,491	2,951	18%	2,908	-1%
3	A141/Gaul Rd	1,643	1,931	18%	1,994	3%
4	A141/Burrowmoor Rd	1,542	1,823	18%	1,905	4%
5	A141/B1101 Wimblington Rd	2,217	2,507	13%	2,454	-2%
6	B1101 Wimblington Rd/Jobs Ln	1,062	1,147	8%	1,035	-10%
7	B1101 Elm Rd/Estover Rd/Norwood Rd	1,429	1,683	18%	1,809	7%
8	B1101 Elm Rd/Twenty Foot Rd	476	597	25%	571	-4%
9	B1101 Station Rd/B1101 Broad St/B1099 Dartford Rd	1,310	1,482	13%	1,468	-1%
10	B1101 High St/Burrowmoor Rd	1,238	1,503	21%	1,536	2%
11	B1101 High St/St Peters Rd	1,059	1,199	13%	1,058	-12%
IP						
1	A141/Hostmoor Ave	2,000	2,357	18%	2,359	0%
2	A141/B1099 Wisbech Rd	2,095	2,461	17%	2,433	-1%
3	A141/Gaul Rd	1,289	1,487	15%	1,516	2%
4	A141/Burrowmoor Rd	1,153	1,337	16%	1,376	3%
5	A141/B1101 Wimblington Rd	1,764	1,976	12%	1,956	-1%
6	B1101 Wimblington Rd/Jobs Ln	855	931	9%	874	-6%
7	B1101 Elm Rd/Estover Rd/Norwood Rd	1,118	1,273	14%	1,373	8%
8	B1101 Elm Rd/Twenty Foot Rd	314	345	10%	341	-1%
9	B1101 Station Rd/B1101 Broad St/B1099 Dartford Rd	1,229	1,391	13%	1,342	-4%
10	B1101 High St/Burrowmoor Rd	1,070	1,241	16%	1,282	3%
11	B1101 High St/St Peters Rd	951	1,042	10%	973	-7%
PM						
1	A141/Hostmoor Ave	2,345	2,791	19%	2,800	0%
2	A141/B1099 Wisbech Rd	2,688	3,078	15%	3,041	-1%
3	A141/Gaul Rd	1,737	2,065	19%	2,065	0%
4	A141/Burrowmoor Rd	1,616	1,940	20%	1,988	2%
5	A141/B1101 Wimblington Rd	2,374	2,635	11%	2,608	-1%
6	B1101 Wimblington Rd/Jobs Ln	990	1,008	2%	954	-5%
7	B1101 Elm Rd/Estover Rd/Norwood Rd	1,423	1,803	27%	1,922	7%
8	B1101 Elm Rd/Twenty Foot Rd	537	711	32%	695	-2%
9	B1101 Station Rd/B1101 Broad St/B1099 Dartford Rd	1,509	1,627	8%	1,631	0%
10	B1101 High St/Burrowmoor Rd	1,321	1,520	15%	1,506	-1%
11	B1101 High St/St Peters Rd	1,197	1,302	9%	1,207	-7%

* Percentage change > +5% = highlighted in bold

Table 6.5 – Total Junction Flow (2021)

ID	Description	2010 Base	2021 DM	DM vs Base	2021 DS1	DS1 vs DM *	2021 DS2	DS2 vs DS1 *	DS2 vs DM *
AM									
1	A141/Hostmoor Ave	2,124	2,719	28%	2,726	0%	2,726	0%	0%
2	A141/B1099 Wisbech Rd	2,491	3,171	27%	3,135	-1%	3,146	0%	-1%
3	A141/Gaul Rd	1,643	2,112	29%	2,265	7%	2,271	0%	8%
4	A141/Burrowmoor Rd	1,542	2,011	30%	2,244	12%	2,255	0%	12%
5	A141/B1101 Wimblington Rd	2,217	2,697	22%	2,583	-4%	2,585	0%	-4%
6	B1101 Wimblington Rd/Jobs Ln	1,062	1,218	15%	934	-23%	936	0%	-23%
7	B1101 Elm Rd/Estover Rd/Norwood Rd	1,429	1,829	28%	2,081	14%	2,078	0%	14%
8	B1101 Elm Rd/Twenty Foot Rd	476	650	37%	586	-10%	588	0%	-10%
9	B1101 Station Rd/B1101 Broad St/B1099 Dartford Rd	1,310	1,495	14%	1,561	4%	1,563	0%	5%
10	B1101 High St/Burrowmoor Rd	1,238	1,557	26%	1,634	5%	1,636	0%	5%
11	B1101 High St/St Peters Rd	1,059	1,248	18%	948	-24%	951	0%	-24%
IP									
1	A141/Hostmoor Ave	2,000	2,538	27%	2,535	0%	2,536	0%	0%
2	A141/B1099 Wisbech Rd	2,095	2,665	27%	2,584	-3%	2,584	0%	-3%
3	A141/Gaul Rd	1,289	1,610	25%	1,636	2%	1,643	0%	2%
4	A141/Burrowmoor Rd	1,153	1,482	29%	1,549	5%	1,551	0%	5%
5	A141/B1101 Wimblington Rd	1,764	2,143	21%	2,105	-2%	2,108	0%	-2%
6	B1101 Wimblington Rd/Jobs Ln	855	991	16%	891	-10%	901	1%	-9%
7	B1101 Elm Rd/Estover Rd/Norwood Rd	1,118	1,405	26%	1,661	18%	1,665	0%	19%
8	B1101 Elm Rd/Twenty Foot Rd	314	391	25%	391	0%	393	1%	1%
9	B1101 Station Rd/B1101 Broad St/B1099 Dartford Rd	1,229	1,491	21%	1,455	-2%	1,467	1%	-2%
10	B1101 High St/Burrowmoor Rd	1,070	1,377	29%	1,541	12%	1,551	1%	13%
11	B1101 High St/St Peters Rd	951	1,155	21%	1,027	-11%	1,031	0%	-11%
PM									
1	A141/Hostmoor Ave	2,345	2,868	22%	2,872	0%	2,869	0%	0%
2	A141/B1099 Wisbech Rd	2,688	3,283	22%	3,198	-3%	3,222	1%	-2%
3	A141/Gaul Rd	1,737	2,277	31%	2,262	-1%	2,271	0%	0%
4	A141/Burrowmoor Rd	1,616	2,138	32%	2,257	6%	2,264	0%	6%
5	A141/B1101 Wimblington Rd	2,374	2,827	19%	2,781	-2%	2,788	0%	-1%
6	B1101 Wimblington Rd/Jobs Ln	990	1,045	6%	907	-13%	936	3%	-10%
7	B1101 Elm Rd/Estover Rd/Norwood Rd	1,423	1,904	34%	2,174	14%	2,168	0%	14%
8	B1101 Elm Rd/Twenty Foot Rd	537	751	40%	726	-3%	728	0%	-3%
9	B1101 Station Rd/B1101 Broad St/B1099 Dartford Rd	1,509	1,690	12%	1,708	1%	1,719	1%	2%
10	B1101 High St/Burrowmoor Rd	1,321	1,573	19%	1,648	5%	1,643	0%	4%
11	B1101 High St/St Peters Rd	1,197	1,336	12%	1,195	-11%	1,207	1%	-10%

* Percentage change > +5% = highlighted in **bold**

Table 6.6 – Total Junction Flow (2026)

ID	Description	2010 Base	2026 DM	DM vs Base	2026 DS1	DS1 vs DM *	2026 DS2	DS2 vs DS1 *	DS2 vs DM *
AM									
1	A141/Hostmoor Ave	2,124	2,824	33%	2,813	0%	2,799	0%	-1%
2	A141/B1099 Wisbech Rd	2,491	3,358	35%	3,394	1%	3,461	2%	3%
3	A141/Gaul Rd	1,643	2,266	38%	2,616	15%	2,710	4%	20%
4	A141/Burrowmoor Rd	1,542	2,211	43%	2,622	19%	2,737	4%	24%
5	A141/B1101 Wimblington Rd	2,217	2,899	31%	2,735	-6%	2,788	2%	-4%
6	B1101 Wimblington Rd/Jobs Ln	1,062	1,255	18%	771	-39%	919	19%	-27%
7	B1101 Elm Rd/Estover Rd/Norwood Rd	1,429	2,027	42%	2,308	14%	2,317	0%	14%
8	B1101 Elm Rd/Twenty Foot Rd	476	733	54%	641	-13%	643	0%	-12%
9	B1101 Station Rd/B1101 Broad St/B1099 Dartford Rd	1,310	1,572	20%	1,629	4%	1,651	1%	5%
10	B1101 High St/Burrowmoor Rd	1,238	1,604	30%	1,646	3%	1,670	1%	4%
11	B1101 High St/St Peters Rd	1,059	1,242	17%	894	-28%	987	10%	-21%
IP									
1	A141/Hostmoor Ave	2,000	2,702	35%	2,728	1%	2,727	0%	1%
2	A141/B1099 Wisbech Rd	2,095	2,870	37%	2,832	-1%	2,886	2%	1%
3	A141/Gaul Rd	1,289	1,741	35%	1,826	5%	1,879	3%	8%
4	A141/Burrowmoor Rd	1,153	1,645	43%	1,835	12%	1,903	4%	16%
5	A141/B1101 Wimblington Rd	1,764	2,363	34%	2,294	-3%	2,314	1%	-2%
6	B1101 Wimblington Rd/Jobs Ln	855	1,070	25%	879	-18%	979	11%	-9%
7	B1101 Elm Rd/Estover Rd/Norwood Rd	1,118	1,605	44%	1,916	19%	1,930	1%	20%
8	B1101 Elm Rd/Twenty Foot Rd	314	473	51%	445	-6%	447	0%	-5%
9	B1101 Station Rd/B1101 Broad St/B1099 Dartford Rd	1,229	1,619	32%	1,596	-1%	1,630	2%	1%
10	B1101 High St/Burrowmoor Rd	1,070	1,504	41%	1,615	7%	1,647	2%	10%
11	B1101 High St/St Peters Rd	951	1,233	30%	987	-20%	1,071	9%	-13%
PM									
1	A141/Hostmoor Ave	2,345	2,933	25%	2,918	-1%	2,909	0%	-1%
2	A141/B1099 Wisbech Rd	2,688	3,564	33%	3,578	0%	3,684	3%	3%
3	A141/Gaul Rd	1,737	2,489	43%	2,622	5%	2,738	4%	10%
4	A141/Burrowmoor Rd	1,616	2,384	48%	2,588	9%	2,725	5%	14%
5	A141/B1101 Wimblington Rd	2,374	3,023	27%	2,998	-1%	3,040	1%	1%
6	B1101 Wimblington Rd/Jobs Ln	990	1,025	4%	872	-15%	984	13%	-4%
7	B1101 Elm Rd/Estover Rd/Norwood Rd	1,423	1,980	39%	2,361	19%	2,335	-1%	18%
8	B1101 Elm Rd/Twenty Foot Rd	537	808	50%	782	-3%	778	-1%	-4%
9	B1101 Station Rd/B1101 Broad St/B1099 Dartford Rd	1,509	1,724	14%	1,720	0%	1,729	1%	0%
10	B1101 High St/Burrowmoor Rd	1,321	1,612	22%	1,677	4%	1,685	0%	5%
11	B1101 High St/St Peters Rd	1,197	1,354	13%	1,190	-12%	1,250	5%	-8%

* Percentage change > +5% = highlighted in **bold**

Journey Time Data

6.62. Cumulative modelled journey times were collated for three routes, two north-south routes and one east-west route. These routes are shown in Figure 6.24 below:

- Pink Route – A141 Northbound and A141 Southbound;
- Red Route – March South to North and March North to South (via B1101); and
- Blue Route – March East to West and March West to East (via B1099/B1101).

6.63. The cumulative journey time graphs for all journey time routes, forecast years, scenarios and time periods are included in Appendix G.

Figure 6.24 – Journey Time Routes

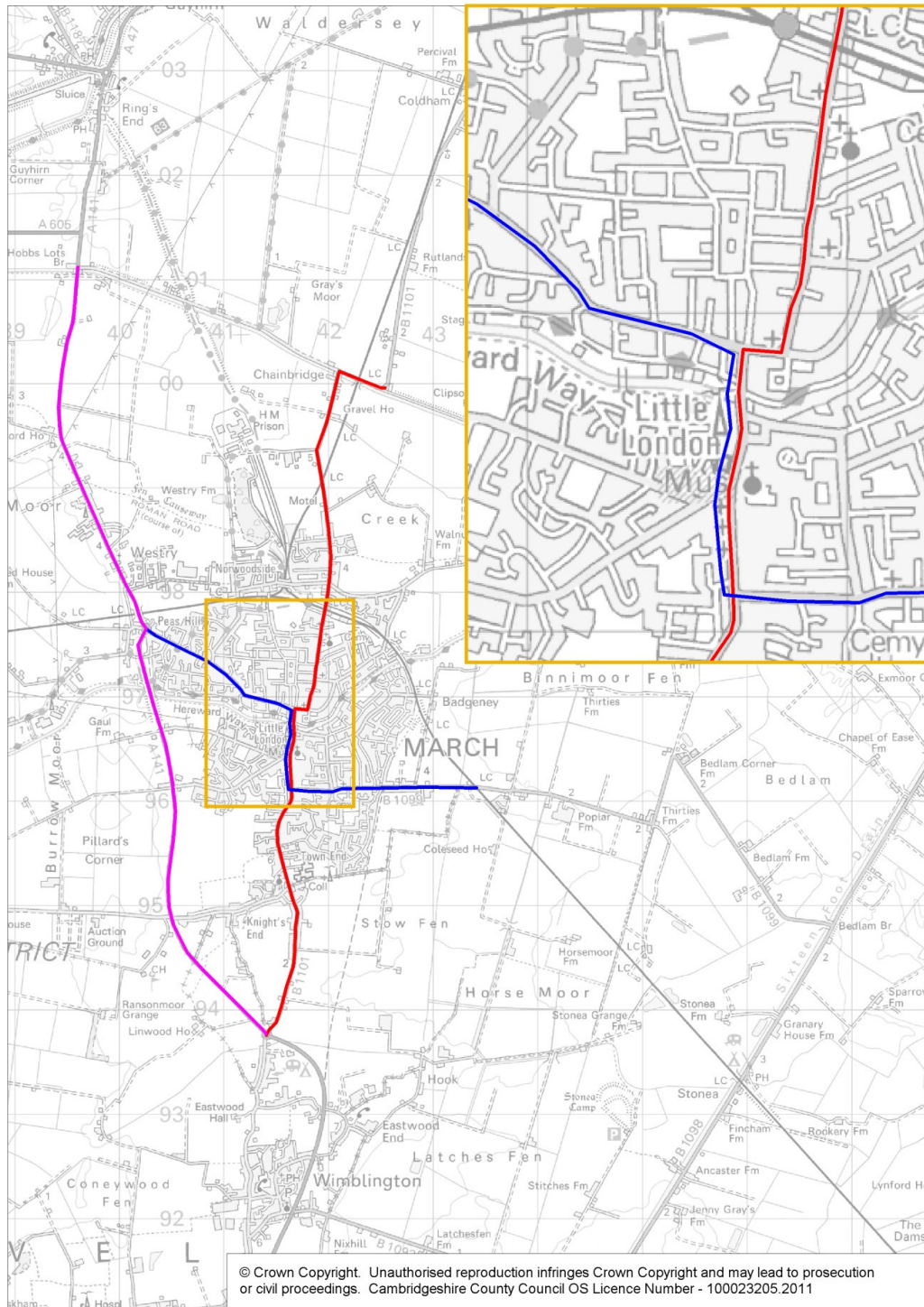

A141 (Pink Route)

- 6.64. For the A141, the journey time is generally proportional to the traffic flow volume that the greater the flow, the longer the journey times. Table 3.1 shows the traffic flow on the A141; Figure G.2 and Figure G.3 show the AM peak journey time; Figure G.8 and Figure G.9 show the inter peak journey time; and Figure G.14 and Figure G.15 show the PM peak journey time.

Northbound

- 6.65. For the A141 northbound, the journey times increase slightly for the AM and inter peak as the demand increase in the forecast years, but the journey time data also suggests that the route is able to accommodate the additional traffic for these two peak hours for all forecast years and scenarios.
- 6.66. However for the A141 northbound PM peak, the model shows that the A141/Hostmoor Avenue junction will begin to have difficulties in accommodating the forecast year traffic in 2021 PM peak (for all scenarios), resulting increase in journey times. For 2026 DM PM peak, the A141/Hostmoor Avenue continues to experience significant delay and the model shows that the A141/B1099 Wisbech Road roundabout junction will also have difficulties in accommodating the additional traffic, resulting in significant increase in delay for this junction. For 2026 DS1 and DS2 PM peak, the northbound traffic flow for the A141 is greater than DM. Whilst the level of delay for A141/Hostmoor Avenue remains fairly consistent at the 2026 DM level, the model shows that the delay for A141/B1099 Wisbech Road roundabout will be greater in the 2026 DS1 and DS2 scenarios when compared to the 2026 DM.

Southbound

- 6.67. The journey time data shows that the A141 southbound is able to accommodate the increase in traffic flow without significant increase in journey time for all forecast years, scenarios and time periods.

March North-South (Red Route)

Northbound

- 6.68. The journey time data shows that this route is beginning to have capacity issues in the 2021 as delay for B1101 High Street/Burrowmoor Road junction increases, particularly in the PM peak.
- 6.69. For 2026, particularly the DS1 and DS2 scenarios where most of the development traffic enters the network directly onto the B1101 or nearby roads, the data shows that the journey times for this route will increase significantly, particularly for the PM peak. For all time periods, journey time comparison between the scenarios for 2026 shows that the delay will be most significant in the DS2 scenario, follow by DS1, then DM.
- 6.70. The data also shows that increase in delay will be most significant for the following junctions:
- B1101 High Street/Burrowmoor Road; and
 - B1101 Elm Road/Twenty Foot Road (PM peak only).

Southbound

- 6.71. For the southbound route, the busiest time period is the AM peak. The AM peak journey time data shows that this route is able to accommodate the additional traffic for all forecast year DM scenarios. However, for the DS1 and DS2 scenarios, the data shows that the delay for B1101 Station Road/B1101 Broad Street/B1099 Dartford Road junction will increase in 2021. For the 2026 DS1 and DS2 scenarios, the model shows that this junction will experience significant increase in delay as the junction reaches its capacity. The B1101 High Street/St Peters Road junction¹ also shows increase in delay suggesting that this junction also have difficulties in accommodating the demand in these DS scenarios.

¹ It is important to note that signal timings for the B1101 High Street/St Peters Road junction have been optimised as part of the SIGOPT process (see Paragraph 4.6), and it is believed that the delay for this junction will be greater if the signal timings have not been updated according to the change in demand in different modelled scenarios.

- 6.72. For the inter peak and PM peak, there are also slight increase in journey times as the demand for the route increase, but the data suggests that the route is able to accommodate the additional traffic for these two peak hours for all forecast years and scenarios.

March East-West (Blue Route)

- 6.73. The journey time data for this route shows similar results to the red route. This route overlaps with the red route between the B1101 High Street/St Peters Road and B1101 Station Road/B1101 Broad Street/B1099 Dartford Road junctions. Similar to the Red Route, this stretch of the B1101 contains some of the most congested junctions in March that are most affected by the forecast year traffic, namely:
- B1101 High Street/St Peters Road;
 - B1101 High Street/Burrowmoor Road;
 - B1101 Station Road/B1101 Broad Street/B1099 Dartford Road

Eastbound

- 6.74. The eastbound blue route overlaps with the southbound red route. Similar to the southbound red route results, the busiest time period for this route is the AM peak and the journey time data shows that there will be significant increase in delay for the following junctions in the 2026 DS1 and DS2 AM peak scenarios:
- B1101 Station Road/B1101 Broad Street/B1099 Dartford Road; and
 - B1101 High Street/ St Peters Road.

- 6.75. For the DM AM peak models, the journey time data shows that there is only slight increase in journey times for all forecast years.

- 6.76. For the inter peak and PM peak, there are also slight increase in journey times as the demand for the route increase, but the data suggests that the route is able to accommodate the additional traffic for these two peak hours for all forecast years and scenarios.

Westbound

- 6.77. The westbound blue route overlaps with the northbound red route. Again, similar to the northbound red route results, the busiest time period for this route is the PM peak. The data shows that the route is able to accommodate the 2016 demand, however for 2021, the delay for B1101 High Street/Burrowmoor Road junction increases, resulting in longer overall journey time for this route. This junction continues to have difficulties in coping with the additional demand in 2026 and the delay increases significantly for all 2026 scenarios.
- 6.78. For the AM and inter peak models, there are also increase in delay for the B1101 High Street/Burrowmoor Road junction, particularly for the 2026 DS 2 scenario.

Summary

- 6.79. The journey time data shows that in general the existing infrastructure is able to accommodate the 2016 demand (for all scenarios) without causing significant increase in delay for all journey time routes.
- 6.80. For 2021, the journey time data shows that some of junctions beginning to show capacity issues for the busier time periods. These junctions include:
- A141/Hostmoor Avenue;
 - B1101 High Street/Burrowmoor Road;
 - B1101 Station Road/B1101 Broad Street.B1988 Dartford Road.
- 6.81. In most cases, the increase in journey times and delay in 2021 for the above junctions occurs in the DM as well the DS1 and DS2 scenarios.
- 6.82. For 2026, the junctions that are operating at capacity in 2021 continue to have difficulties accommodating the additional demand in 2026, resulting in significant increase in delay for these

junctions. The delays for these junctions are most significant in the DS2 scenario, follow by DS1 scenario, then DM scenario.

- 6.83. The journey time data also shows that although the A141/B1099 Wisbech Road roundabout junction can accommodate the 2026 DM demand, it has capacity issue in the 2026 DS1 and DS2 scenarios. The demand for the A141 for the DS scenarios are greater than the DM, and the modelling shows significant increase in delay for this junction for the DS scenarios.

7. Summary



Summary

- 7.1. This report presents the traffic forecasting methodology and results for the March Area Transport Study.
- 7.2. The forecast year models have been developed from the validated 2010 base year MATS model, and the modelling has been carried out for three forecast years, three scenarios and three time periods:
- Forecast Years: 2016; 2021 and 2026.
 - Scenarios: Do Minimum (incl. Committed Developments only);
Do Something Test 1 (incl. Committed Developments & SFF Opportunity Zone 1a & 1b); and
Do Something Test 2 (incl. Committed Developments & SFF Opportunity Zone 1a, 1b, 2a & 2b).
 - Time Periods: AM peak (0800-0900); Inter peak (Average hour between 1000 and 1600); and PM peak (1700-1800).
- 7.3. A variety of data, including flow and journey time data, has been extracted from the forecast year SATURN models to show the impact of the forecast year traffic on the March network.
- 7.4. The average model speeds from the model assignment summary statistics reduce only slightly for the forecast year models when compared to the 2010 base year models. This suggests that overall, the March network is able to accommodate the additional demand in the forecast years without causing network-wide delay and congestion. However, increases in delay are expected for some of the busiest junctions in March as shown by other more detailed model data analysis.
- 7.5. The modelled data shows that the A141 and B1101 corridors will be most affected by the forecast year traffic. These two routes provide the only two crossing points for River Nene and are the two most important transport corridors for the March network. They are some of the busiest routes in the 2010 base year scenario and the modelling results for forecast year scenarios show that some junctions on these two routes will have difficulties in accommodating the forecast year traffic, resulting in significant increase in delay and journey times.
- 7.6. The modelling shows that for 2016, the March network is generally able to accommodate the increase in background and SFF Opportunity Zone traffic. Due to the large committed development in the Hostmoor Avenue Industrial Area, the A141/Hostmoor Avenue junction begin to show strain in accommodating the additional traffic, resulting in slight increase in delay for this junction. The northbound approach to the B1101 Elm Road/Twenty Foot Road junction also shows high V/C in the PM peak due to increase in northbound flow from the background growth applied.
- 7.7. For 2021, the modelling shows that some of the junctions on the A141 and B1101 have difficulties in accommodating the forecast year traffic. These junctions include:
- A141/Hostmoor Avenue;
 - B1101 High Street/Burrowmoor Road;
 - B1101 Station Road/B1101 Broad Street/B1099 Dartford Road;
 - A141/B1099 Wisbech Road; and
 - B1101 Elm Road/Twenty Foot Road (PM peak only).
- 7.8. The traffic growth profile for the A141 and B1101 shows that the rate of traffic growth for B1101 reduces whilst growth for the A141 increases in post 2021, suggesting that as congestion increases for the B1101 corridor, traffic chooses to use the A141 to travel from north to south and vice versa. For the A141/B1099 Wisbech Road roundabout, the A141 approach arms are very busy with high link V/C values (>80%) for both A141 northbound and southbound approaches to the roundabout for both AM and PM peak.

- 7.9. For 2026, the junctions as listed in Paragraph 7.7 continue to show significant delay and congestion. For the A141/B1099 Wisbech roundabout, the journey time data shows that it will be operating at capacity and significant delay is expected at this junction in 2026, particularly in the PM peak.
- 7.10. For the junctions that are located in close proximity to the SFF Opportunity Zones, all are expected to have an increase in traffic flow. For B1101 Wimblington Road/Jobs Lane (Opportunity Zone 2) and B1101 Elm Road/Estover Road/Norwood Road (Opportunity Zone 1a) junctions, the modelling shows that they are able to accommodate the development traffic without significantly affecting the operation of the junctions. For B1101 High Street/Burrowmoor Road (Opportunity Zone 1b), the modelling shows that this junction will have difficulties in accommodating the additional development traffic, resulting in additional delay for this junction.
- 7.11. It should be noted that although the Opportunity Zone development traffic might not have negative impacts on the junctions immediately adjacent to the development sites, all Opportunity Zone developments are expected to increase the traffic flow in March town centre, putting extra strain on some of the busiest junctions in the network (as discussed in Paragraph 7.7 and 7.9) and increase the delay in the March network.
- 7.12. Comparison of the modelling results between DS scenarios and DM scenario shows that
- For 2016, the existing infrastructure can support the additional Opportunity Zone development traffic without causing significant delay to the overall network and key junctions in March.
 - For 2021, as the network and junctions are busier with the higher DM demand, the modelling results show that some individual junctions begin to have difficulties in accommodating the additional Opportunity Zone development traffic. The modelling shows that the development traffic is expected to increase delay for some of the key junctions in March town centre, such as B1101 High Street/Burrowmoor Road and B1101 Station Road/B1101 Broad Street/B1099 Dartford Road junctions. The A141 approaches for the A141/B1099 Wisbech Road roundabout are also operating close to capacity and delay can be expected for certain junction movements.
 - For 2026, the additional Opportunity Zone development traffic causes further delay to the junctions in March town centre and also the junctions on the A141. From the journey time data, both DS1 and DS2 scenarios will cause increase in delay and journey time for the following junctions when compared to the relevant DM scenario:
 - A141/B1099 Wisbech Road;
 - A141/Gaul Road;
 - A141/Burrowmoor Road;
 - B1101 High Street/Burrowmoor Road;
 - B1101 High Street/St Peters Road²; and
 - B1101 Station Road/B1101 Broad Street/B1099 Dartford Road.

As discussed above, the overall average model speeds for the DS scenarios reduce only slightly when compared to the 2010 base year models, suggesting that the increase in delay caused by the additional Opportunity Zone development traffic for both DS1 and DS2 scenarios is not network-wide but for the above isolated junctions only. However it is recommended that transport improvements to be considered for the above junctions for any developments post 2021 to mitigate the impact of the additional development traffic on the operation of these junctions, particularly for the junctions on the A141 as it is used by strategic traffic.

² B1101 High Street/St Peters Road junction is a signalised junction. As discussed in Chapter 6, signal timing optimisation was undertaken as part of the modelling process to ensure the delay at this junction is minimised in the forecast years, and it should be noted that without signal timing optimisation, greater delay and congestion can be expected at this junction in the forecast years.

A. Calculation of PPM and PPK Values

Calculations of PPM and PPK Values

Introduction

- A.1 Two important parameters that are input to SATURN models are Pence per Minute (PPM) and Pence per Kilometre (PPK) values. These represent the travellers' valuation of the time and distance of each journey, and the ratio between the two. The interaction of these parameters has significant effect on route choice. If time is highly valued but distance is not, then the quickest route will be chosen no matter how far it is; conversely, if distance is highly valued but time is not, the shortest route would be chosen no matter how slow it is. Generally, the route choice is a balance between the relative importance of time and distance to the traveller.
- A.2 These parameters are predicted to change through time: they were calculated for the 2010 base year (as described in the MATS Local Model Validation Report), and have been calculated using the same method for the forecast years (as described below).

Value to Time Costs: Pence per Minute

- A.3 The PPM model parameter was calculated based on time costs from WebTAG Unit 3.5.6D (dated March 2010). All references to WebTAG in the following paragraphs refer to WebTAG Unit 3.5.6D.
- A.4 WebTAG Table 1 provides the latest Values of Working Time per person, recommended by the DfT, expressed in 2002 values and prices in pounds per hour. These values are given in Table A.1. These have been applied to the EB trips purpose for cars and LGV (i.e. UC3), and to OGV1 and OGV2 (i.e. UC5 and UC6).

Table A.1 – 2002 Values of Working Time per Person (2002 prices, £/hour)

Vehicle Occupant	Resource Cost	Perceived Cost	Market Price
Car driver	21.86	21.86	26.43
Car passenger	15.66	15.66	18.94
LGV (driver or passenger)	8.42	8.42	10.18
OGV1/OGV2 (driver or passenger)	8.42	8.42	10.18

- A.5 WebTAG Table 2 provides the latest Values of Non-Working Time per person, expressed in 2002 values and prices in pounds per hour. These values are given in Table A.2. 'Commuting' values have been applied to HBW (i.e. UC1) and HBEd (i.e. UC2) trip purposes; 'other' values have been applied to the other trip purposes (i.e. UC4).

Table A.2 – 2002 Values of Non-Working Time per Person (2002 prices, £/hour)

Purpose	Resource Cost	Perceived Cost	Market Price
Commuting	4.17	5.04	5.04
Other	3.68	4.46	4.46

- A.6 Vehicle occupancies for the 2010 base year (Table A.5), proportion of travel for each purpose (Table A.9) and proportions of vehicles making up each user class (Table A.10) have all been calculated from the 2010 RSI data that was collected in March for this study.
- A.7 Vehicle occupancies for the forecast years (Table A.6 to Table A.8) have been calculated from these base year values using the annual percentage change given in WebTAG Table 6 (reproduced in Table A.3). The changes in vehicle occupancies from 2010 to 2016, 2021 and 2026 are give in Table A.4.
- A.8 Proportion of travel for each purpose and proportions of vehicles making up each user class are assumed to remain constant from 2010 to 2026.

Table A.3 – Annual Percentage Change in Car Passenger Occupancy (%pa) up to 2036

Journey Purpose	Weekday AM	Weekday IP	Weekday PM
Work	-0.48	-0.4	-0.62
Non-Work (commuting and other)	-0.67	-0.65	-0.53

Table A.4 – Change in Car Passenger Occupancy (2010 to 2016, 2021 and 2026)

Journey Purpose	2010 to 2016	2010 to 2021	2010 to 2026
Work – AM	0.972	0.948	0.926
Work – IP	0.976	0.957	0.938
Work – PM	0.963	0.934	0.905
Non-Work – AM	0.960	0.929	0.898
Non-Work – IP	0.962	0.931	0.901
Non-Work – PM	0.969	0.943	0.918

Table A.5 – 2010 Vehicle Occupancy per Trip (including driver)

Vehicle Type / Journey Purpose	2010 RSI Data		
	AM	IP	PM
Car / HBW (UC1)	1.10	1.11	1.14
Car / HBEd (UC2)	2.10	1.52	1.92
Car / EB (UC3)	1.16	1.13	1.27
Car / OTP (UC4)	1.47	1.48	1.52
LGV / HBW (UC1)	1.06	1.32	1.23
LGV / HBEd (UC2)	2.00	-	1.00
LGV / EB (UC3)	1.21	1.23	1.13
LGV / OTP (UC4)	1.32	1.39	1.50
OGV1 / Work (UC5)	1.27	1.17	1.50
OGV2 / Work (UC6)	1.00	1.00	1.00

Table A.6 – 2016 Vehicle Occupancy per Trip (including driver)

Vehicle Type / Journey Purpose	AM	IP	PM
Car / HBW (UC1)	1.10	1.11	1.14
Car / HBEd (UC2)	2.06	1.50	1.89
Car / EB (UC3)	1.15	1.12	1.26
Car / OTP (UC4)	1.45	1.47	1.50
LGV / HBW (UC1)	1.05	1.30	1.22
LGV / HBEd (UC2)	1.96	-	1.00
LGV / EB (UC3)	1.20	1.22	1.13
LGV / OTP (UC4)	1.30	1.38	1.48
OGV1 / Work (UC5)	1.26	1.16	1.48
OGV2 / Work (UC6)	1.00	1.00	1.00

Table A.7 – 2021 Vehicle Occupancy per Trip (including driver)

Vehicle Type / Journey Purpose	AM	IP	PM
Car / HBW (UC1)	1.10	1.10	1.13
Car / HBEd (UC2)	2.02	1.48	1.86
Car / EB (UC3)	1.15	1.12	1.25
Car / OTP (UC4)	1.44	1.45	1.49
LGV / HBW (UC1)	1.05	1.30	1.21
LGV / HBEd (UC2)	1.93	-	1.00
LGV / EB (UC3)	1.20	1.22	1.12
LGV / OTP (UC4)	1.29	1.37	1.47
OGV1 / Work (UC5)	1.26	1.16	1.47
OGV2 / Work (UC6)	1.00	1.00	1.00

Table A.8 – 2026 Vehicle Occupancy per Trip (including driver)

Vehicle Type / Journey Purpose	AM	IP	PM
Car / HBW (UC1)	1.09	1.10	1.13
Car / HBEd (UC2)	1.99	1.47	1.84
Car / EB (UC3)	1.14	1.12	1.24
Car / OTP (UC4)	1.42	1.44	1.48
LGV / HBW (UC1)	1.05	1.29	1.21
LGV / HBEd (UC2)	1.90	-	1.00
LGV / EB (UC3)	1.19	1.21	1.12
LGV / OTP (UC4)	1.28	1.36	1.46
OGV1 / Work (UC5)	1.25	1.15	1.46
OGV2 / Work (UC6)	1.00	1.00	1.00

Table A.9 – Proportion of Vehicle Travelling for Each Purpose (2010, 2016, 2021 and 2026)

Vehicle Type / Journey Purpose	AM	IP	PM
Car / HBW (UC1)	46%	19%	40%
Car / HBEd (UC2)	4%	2%	4%
Car / EB (UC3)	11%	11%	7%
Car / OTP (UC4)	39%	68%	49%
Car / All Purposes (UC1 to UC4)	100%	100%	100%
LGV / HBW (UC1)	40%	22%	33%
LGV / HBEd (UC2)	1%	0%	1%
LGV / EB (UC3)	39%	54%	23%
LGV / OTP (UC4)	20%	24%	43%
LGV / All Purposes (UC1 to UC4)	100%	100%	100%
OGV1 / Work (UC5)	100%	100%	100%
OGV2 / Work (UC6)	100%	100%	100%

Table A.10 – Proportion of Vehicle Type in Each User Class (2010, 2016, 2021 and 2026)

User Class	Vehicle Type	AM	IP	PM
UC1	Car	86%	87%	92%
	LGV	14%	13%	8%
UC2	Car	97%	100%	97%
	LGV	3%	0%	3%
UC3	Car	60%	61%	72%
	LGV	40%	39%	28%
UC4	Car	92%	96%	91%
	LGV	8%	4%	9%
UC5	OGV1	100%	100%	100%
UC6	OGV2	100%	100%	100%

A.9 The 2002 value of time costs for each vehicle type and journey purposes (car, LGV, OGV1 and OGV2; HBW, HBEd, EB and OTP) were combined in the relevant proportions of occupancy (Table A.5) and purpose (Table A.9) to derive the values of time cost in 2002 values (at 2002 prices), given in Table A.11.

Table A.11 – 2002 Perceived Values of Time per Vehicle (2002 prices, £/hour)

Vehicle Type	Journey Purpose	AM	IP	PM
Car	HBW	5.57	5.60	5.74
	HBEd	10.60	7.65	9.66
	EB	24.29	23.82	26.04
	OTP	6.56	6.62	6.78
LGV	HBW	5.33	6.64	6.18
	HBEd	10.08	-	5.04
	EB	10.15	10.34	9.54
	OTP	5.87	6.22	6.69
OGV1	Work	10.72	9.82	12.63
OGV2	Work	8.42	8.42	8.42

A.10 WebTAG Table 3 provides the forecast growth in the values of time for 2002 onwards, which have been used to calculate growth factors from 2002 to 2016, 2021 and 2026. These figures are shown in Table A.12.

Table A.12 – Forecast Growth in the Working and Non-Working Values of Time

Year	GDP Growth (%pa)	Population Growth (%pa)	Work VOT Growth (%pa)	Non-Work VOT Growth (%pa)
2002-2003	2.81	0.36	2.44	1.95
2003-2004	2.95	0.39	2.55	2.04
2004-2005	2.17	0.49	1.67	1.34
2005-2006	2.85	0.66	2.18	1.74
2006-2007	2.56	0.58	1.97	1.57
2007-2008	0.55	0.64	-0.09	-0.07
2008-2009	-4.75	0.67	-5.38	-4.31
2009-2010	1.25	0.73	0.52	0.41
2010-2011	3.50	0.73	2.75	0.20
2011-2012	3.25	0.71	2.52	2.01
2012-2013	3.25	0.70	2.54	2.03
2013-2014	3.25	0.69	2.54	2.03
2014-2015	2.75	0.69	2.05	1.64
2015-2016	2.75	0.69	2.05	1.64
2016-2021	2.35	0.67	1.67	1.34
2021-2031	2.25	0.57	1.67	1.34
2002-2016	-	-	1.220	1.173
2002-2021	-	-	1.325	1.253
2002-2026	-	-	1.440	1.340

A.11

The 2002 values of time (Table A.11) were combined with the 2002 to 2010 factor (Table A.12) to give the 2016, 2021 and 2026 values of time, at 2002 prices in pounds per hour (Table A.13 to Table A.15).

Table A.13 – 2016 Perceived Values of Time per Vehicles (2002 prices, £/hour)

Vehicle Type	Journey Purpose	AM	IP	PM
Car	HBW	6.53	6.57	6.74
	HBEEd	12.43	8.98	11.33
	EB	29.63	29.05	31.76
	OTP	7.70	7.76	7.95
LGV	HBW	6.25	7.78	7.25
	HBEEd	11.82	-	5.91
	EB	12.39	12.61	11.64
	OTP	6.88	7.30	7.85
OGV1	Work	13.07	11.98	15.41
OGV2	Work	10.27	10.27	10.27

Table A.14 – 2021 Perceived Values of Time per Vehicles (2002 prices, £/hour)

Vehicle Type	Journey Purpose	AM	IP	PM
Car	HBW	6.98	7.02	7.20
	HBEd	13.28	9.59	12.11
	EB	32.19	31.56	34.50
	OTP	8.23	8.30	8.50
LGV	HBW	6.68	8.32	7.75
	HBEd	12.64	-	6.32
	EB	13.45	13.70	12.64
	OTP	7.36	7.80	8.39
OGV1	Work	14.20	13.02	16.74
OGV2	Work	11.16	11.16	11.16

Table A.15 – 2026 Perceived Values of Time per Vehicles (2002 prices, £/hour)

Vehicle Type	Journey Purpose	AM	IP	PM
Car	HBW	7.46	7.50	7.69
	HBEd	14.20	10.25	12.94
	EB	34.97	34.29	37.48
	OTP	8.80	8.87	9.08
LGV	HBW	7.13	8.89	8.28
	HBEd	13.50	-	6.75
	EB	14.62	14.88	13.74
	OTP	7.86	8.33	8.96
OGV1	Work	15.43	14.14	18.18
OGV2	Work	12.12	12.12	12.12

A.12

The 2016, 2021 and 2026 values of time were converted from vehicle type to user classes using the proportions given in Table A.10. The PPM parameter was established by converting these values of time in pounds per hour to pence per minute. The values used within the base year MATS SATURN highway model are shown in Table A.16 to Table A.18.

Table A.16 – 2016 Perceived Values of Time per Vehicles (2002 prices, £/hour)

User Class	Value of Time	AM	IP	PM
UC1	£/hour	6.49	6.73	6.78
	PPM	10.82	11.21	11.30
UC2	£/hour	12.41	8.98	11.18
	PPM	20.68	14.96	18.63
UC3	£/hour	22.75	22.63	26.21
	PPM	37.92	37.71	43.68
UC4	£/hour	7.63	7.74	7.94
	PPM	12.72	12.91	13.23
UC5	£/hour	13.07	11.98	15.41
	PPM	21.79	19.97	25.68
UC6	£/hour	10.27	10.27	10.27
	PPM	17.12	17.12	17.12

Table A.17 – 2021 Perceived Values of Time per Vehicles (2002 prices, £/hour)

User Class	Value of Time	AM	IP	PM
UC1	£/hour	6.94	7.19	7.25
	PPM	11.56	11.99	12.08
UC2	£/hour	13.26	9.59	11.95
	PPM	22.10	15.99	19.91
UC3	£/hour	24.71	24.58	28.47
	PPM	41.19	40.97	47.45
UC4	£/hour	8.16	8.28	8.49
	PPM	13.59	13.79	14.14
UC5	£/hour	14.20	13.02	16.74
	PPM	23.67	21.69	27.89
UC6	£/hour	11.16	11.16	11.16
	PPM	18.60	18.60	18.60

Table A.18 – 2026 Perceived Values of Time per Vehicles (2002 prices, £/hour)

User Class	Value of Time	AM	IP	PM
UC1	£/hour	7.41	7.69	7.74
	PPM	12.36	12.81	12.91
UC2	£/hour	14.18	10.25	12.77
	PPM	23.63	17.09	21.28
UC3	£/hour	26.85	26.70	30.93
	PPM	44.75	44.51	51.55
UC4	£/hour	8.72	8.85	9.07
	PPM	14.53	14.74	15.12
UC5	£/hour	15.43	14.14	18.18
	PPM	25.71	23.57	30.30
UC6	£/hour	12.12	12.12	12.12
	PPM	20.20	20.20	20.20

Distance Costs: Pence per Kilometer

- A.13 The PPK value (also known as Vehicle Operation Cost (VOC)) is partially based on speed within the model. The speeds for the forecast year models were obtained by running the models using the 2010 base year PPM and PPK value to provide an initial estimate of the model speed (Table A.19).

Table A.19 – Forecast Year Model Speeds (kph)

Forecast Year	AM	IP	PM
2016	63	68	60
2021	62	67	59
2026	61	66	58

- A.14 WebTAG 3.5.6D gives details on the calculations required to produce the VOC, which are composed of a fuel element and non-fuel element.

Fuel Element

- A.15 WebTAG Table 10 gives the values of the four parameters that are used to calculate fuel consumption. The parameters are expressed in average 2002 values and prices and these have been reproduced in Table A.20) below.

Table A.20 – 2002 Fuel VOC Formulae Parameter Values (2002 prices, litres/kilometre)

Vehicle Category	Parameters			
	a	b	c	d
Average Car	0.9574479	0.04782644	-0.00012946	2.53734E-06
Average LGV	1.162824392	0.061032451	-0.00049695	8.63611E-06
OGV1	1.564481329	0.260097879	-0.00378306	3.24446E-05
OGV2	3.613294863	0.42026914	-0.00494704	3.82806E-05

- A.16 These parameters, along with the average speed (v) for each time period, are used to calculate the fuel consumption for each forecast year model using the following formula. The results are shown in Table A.21.

$$L = (a + bv + cv^2 + dv^3)/v$$

Where:

L = fuel consumption, expressed in litres per kilometre;

v = average speed in kilometres per hour; and

a, b, c, d are parameters defined for each vehicle category.

Table A.21 – 2002 Fuel Consumption Values (2002 prices, litres/kilometre)

Vehicle Category	AM Ave Speed (kph)	AM Fuel Consumption (litre/km)	IP Ave Speed (kph)	IP Fuel Consumption (litre/km)	PM Ave Speed (kph)	PM Fuel Consumption (litre/km)
2016						
Average Car	63.01	0.065	67.74	0.065	60.25	0.065
Average LGV	63.01	0.082	67.74	0.084	60.25	0.082
OGV1	63.01	0.175	67.74	0.176	60.25	0.176
OGV2	63.01	0.318	67.74	0.314	60.25	0.321
2021						
Average Car	62.20	0.065	66.87	0.065	59.35	0.065
Average LGV	62.20	0.082	66.87	0.084	59.35	0.082
OGV1	62.20	0.175	66.87	0.176	59.35	0.176
OGV2	62.20	0.319	66.87	0.315	59.35	0.322
2026						
Average Car	61.29	0.065	65.79	0.065	58.15	0.065
Average LGV	61.29	0.082	65.79	0.083	58.15	0.081
OGV1	61.29	0.176	65.79	0.175	58.15	0.177
OGV2	61.29	0.320	65.79	0.315	58.15	0.324

A.17

In order to factor these 2002 fuel efficiency values to 2016, 2021 and 2026 levels, WebTAG Table 13 was used (reproduced in Table A.22).

Table A.22 – Fuel Efficiency Improvements

Year	Change in Vehicle Efficiency (%pa)			
	Average Car	Average LGV	OGV1	OGV2
2002-2003	-0.79	0.64	0.46	-0.17
2003-2004	-0.83	-1.42	0	0
2004-2005	-1.04	-1.78	0	0
2005-2006	-1.02	-1.49	-1.23	-1.23
2006-2007	-0.44	-1.49	-1.23	-1.23
2007-2008	-1.06	-1.49	-1.23	-1.23
2008-2010	-1.11	-1.49	-1.23	-1.23
2010-2015	-1.25	0	0	0
2015-2020	-2.58	0	0	0
2020-2025	-3.54	0	0	0
2025-2030	-2.58	0	0	0
2002-2016	0.8493	0.9040	0.9443	0.9384
2002-2021	0.7379	0.9040	0.9443	0.9384
2002-2026	0.6223	0.9040	0.9443	0.9384

- A.18 Multiplying these factors (Table A.22) by the 2002 fuel consumption values (Table A.21) gives the 2016, 2021 and 2026 fuel consumption values which is provided in Table A.23.

Table A.23 – 2016, 2021 and 2026 Fuel Consumption Values (litres/kilometre)

Vehicle Category	AM	IP	PM
2016			
Average Car	0.055	0.055	0.055
Average LGV	0.075	0.076	0.074
OGV1	0.166	0.166	0.166
OGV2	0.298	0.295	0.301
2021			
Average Car	0.048	0.048	0.048
Average LGV	0.074	0.076	0.074
OGV1	0.166	0.166	0.166
OGV2	0.299	0.295	0.303
2026			
Average Car	0.040	0.040	0.041
Average LGV	0.074	0.075	0.074
OGV1	0.166	0.166	0.167
OGV2	0.300	0.296	0.304

- A.19 WebTAG Table 11 gives the 2008 resource costs for fuel and WebTAG Table 14 gives the forecast growth for future years. These have been combined to give the 2016, 2021 and 2026 fuel costs, in 2002 prices, shown in Table A.24 below.

Table A.24 – 2016, 2021 and 2026 Fuel Costs (2002 prices, pence/litre)

Vehicle Category	Fuel	Duty	Tax	Pence/litre
2016				
Car (work)	34.34	51.90	-	86.24
Car (non-work)	34.34	51.90	17.50	101.33
LGV (work)	36.19	51.90	-	88.09
LGV (non-work)	36.19	51.90	17.50	103.50
OGV1	36.32	51.90	-	88.22
OGV2	36.32	51.90	-	88.22
2021				
Car (work)	36.15	51.90	-	88.05
Car (non-work)	36.15	51.90	17.50	103.46
LGV (work)	38.11	51.90	-	90.01
LGV (non-work)	38.11	51.90	17.50	105.76
OGV1	38.25	51.90	-	90.15
OGV2	38.25	51.90	-	90.15
2026				
Car (work)	37.96	51.90	-	89.86
Car (non-work)	37.96	51.90	17.50	105.58
LGV (work)	40.01	51.90	-	91.91
LGV (non-work)	40.01	51.90	17.50	108.00
OGV1	40.17	51.90	-	92.07
OGV2	40.17	51.90	-	92.07

A.20 These fuel costs (Table A.24) can be multiplied by the fuel consumption values (Table A.23) to produce the fuel element of the VOC, which is provided in Table A.25 below.

Table A.25 – 2016, 2021 and 2026 Fuel Element of VOC (2002 prices, pence/kilometre)

Vehicle Category	AM litre/km	AM pence/km	IP litre/km	IP pence/km	PM litre/km	PM pence/km
2016						
Car (work)	0.055	4.756	0.055	4.749	0.055	4.770
Car (non-work)	0.055	5.588	0.055	5.580	0.055	5.605
LGV (work)	0.075	6.567	0.076	6.702	0.074	6.509
LGV (non-work)	0.075	7.716	0.076	7.875	0.074	7.648
OGV1	0.166	14.610	0.166	14.647	0.166	14.655
OGV2	0.298	26.317	0.295	26.009	0.301	26.587
2021						
Car (work)	0.048	4.222	0.048	4.212	0.048	4.237
Car (non-work)	0.048	4.961	0.048	4.949	0.048	4.978
LGV (work)	0.074	6.690	0.076	6.819	0.074	6.635
LGV (non-work)	0.074	7.861	0.076	8.012	0.074	7.796
OGV1	0.166	14.937	0.166	14.949	0.166	15.001
OGV2	0.299	26.965	0.295	26.620	0.303	27.272
2026						
Car (work)	0.040	3.637	0.040	3.626	0.041	3.654
Car (non-work)	0.040	4.274	0.040	4.261	0.041	4.293
LGV (work)	0.074	6.812	0.075	6.929	0.074	6.758
LGV (non-work)	0.074	8.004	0.075	8.141	0.074	7.941
OGV1	0.166	15.270	0.166	15.251	0.167	15.364
OGV2	0.300	27.630	0.296	27.250	0.304	28.007

Non-Fuel Element

A.21 WebTAG Paragraph 1.3.16 gives a formula for calculating the non-fuel element of VOC (in pence per kilometre), which includes expenses such as oil, tyres, maintenance and depreciation for all vehicles, along with a vehicle capital saving for vehicles in working time only. The formula is:

$$C = a1 + \frac{b1}{v}$$

Where:

C = cost in pence per kilometre travelled;

v = average link speed in kilometres per hour;

A.22 WebTAG Table 15 gives the values of parameters $a1$ and $b1$ for input to the above formula, reproduced in Table A.26.

Table A.26 – Non-Fuel Element Formula Parameter Values

Vehicle Category	Parameter Values	
	$a1$ (pence/km)	$b1$ (pence/km)
Car (work)	4.069	111.391
Car (non-work)	3.151	-
LGV (work)	5.910	38.603
LGV (non-work)	5.910	-
OGV1	5.501	216.165
OGV2	10.702	416.672

A.23

Using the average speed (v) for each time period, the non-fuel element of the VOC can be calculated (Table A.27).

Table A.27 – Non-Fuel Element of VOC (2002 prices, pence/kilometre)

Vehicle Category	AM Ave Speed (kph)	AM Non-Fuel VOC (pence/km)	IP Ave Speed (kph)	IP Non-Fuel VOC (pence/km)	PM Ave Speed (kph)	PM Non-Fuel VOC (pence/km)
2016						
Car (work)	63.01	5.84	67.74	5.71	60.25	5.92
Car (non-work)	63.01	3.15	67.74	3.15	60.25	3.15
LGV (work)	63.01	6.52	67.74	6.48	60.25	6.55
LGV (non-work)	63.01	5.91	67.74	5.91	60.25	5.91
OGV1	63.01	8.93	67.74	8.69	60.25	9.09
OGV2	63.01	17.31	67.74	16.85	60.25	17.62
2021						
Car (work)	62.20	5.86	66.87	5.73	59.35	5.95
Car (non-work)	62.20	3.15	66.87	3.15	59.35	3.15
LGV (work)	62.20	6.53	66.87	6.49	59.35	6.56
LGV (non-work)	62.20	5.91	66.87	5.91	59.35	5.91
OGV1	62.20	8.98	66.87	8.73	59.35	9.14
OGV2	62.20	17.40	66.87	16.93	59.35	17.72
2026						
Car (work)	61.29	5.89	65.79	5.76	58.15	5.98
Car (non-work)	61.29	3.15	65.79	3.15	58.15	3.15
LGV (work)	61.29	6.54	65.79	6.50	58.15	6.57
LGV (non-work)	61.29	5.91	65.79	5.91	58.15	5.91
OGV1	61.29	9.03	65.79	8.79	58.15	9.22
OGV2	61.29	17.50	65.79	17.04	58.15	17.87

Total Vehicle Operating Cost

A.24

The fuel and non-fuel elements of VOC are summed to give the total VOC for each vehicle category for each time period, shown in Table A.28.

Table A.28 – Total VOC for Each Vehicle Category (2002 prices, pence/kilometre)

Vehicle Category	AM			IP			PM		
	Fuel VOC	Non-Fuel VOC	Total VOC	Fuel VOC	Non-Fuel VOC	Total VOC	Fuel VOC	Non-Fuel VOC	Total VOC
2016									
Car (work)	4.76	5.84	10.59	4.75	5.71	10.46	4.77	5.92	10.69
Car (non-work)	5.59	3.15	8.74	5.58	3.15	8.73	5.60	3.15	8.76
LGV (work)	6.57	6.52	13.09	6.70	6.48	13.18	6.51	6.55	13.06
LGV (non-work)	7.72	5.91	13.63	7.87	5.91	13.78	7.65	5.91	13.56
OGV1	14.61	8.93	23.54	14.65	8.69	23.34	14.66	9.09	23.74
OGV2	26.32	17.31	43.63	26.01	16.85	42.86	26.59	17.62	44.20
2021									
Car (work)	4.22	5.86	10.08	4.21	5.73	9.95	4.24	5.95	10.18
Car (non-work)	4.96	3.15	8.11	4.95	3.15	8.10	4.98	3.15	8.13
LGV (work)	6.69	6.53	13.22	6.82	6.49	13.31	6.64	6.56	13.20
LGV (non-work)	7.86	5.91	13.77	8.01	5.91	13.92	7.80	5.91	13.71
OGV1	14.94	8.98	23.91	14.95	8.73	23.68	15.00	9.14	24.14
OGV2	26.97	17.40	44.37	26.62	16.93	43.55	27.27	17.72	44.99
2026									
Car (work)	3.64	5.89	9.52	3.63	5.76	9.39	3.65	5.98	9.64
Car (non-work)	4.27	3.15	7.42	4.26	3.15	7.41	4.29	3.15	7.44
LGV (work)	6.81	6.54	13.35	6.93	6.50	13.43	6.76	6.57	13.33
LGV (non-work)	8.00	5.91	13.91	8.14	5.91	14.05	7.94	5.91	13.85
OGV1	15.27	9.03	24.30	15.25	8.79	24.04	15.36	9.22	24.58
OGV2	27.63	17.50	45.13	27.25	17.04	44.29	28.01	17.87	45.88

A.25 Using the proportions of vehicles given in Table A., the PPK values for each user class can be derived – these are shown in Table A.29.

Table A.29 – 2016, 2021 and 2026 Vehicle Operating Costs (PPK) (2002 prices)

User Class	AM	IP	PM
2016			
UC1	9.40	9.39	9.16
UC2	8.90	8.73	8.89
UC3	11.59	11.52	11.34
UC4	9.14	8.95	9.20
UC5	23.54	23.34	23.74
UC6	43.63	42.86	44.20
2021			
UC1	8.88	8.86	8.60
UC2	8.29	8.10	8.28
UC3	11.33	11.26	11.01
UC4	8.58	8.36	8.64
UC5	23.91	23.68	24.14
UC6	44.37	43.55	44.99
2026			
UC1	8.30	8.28	7.98
UC2	7.63	7.41	7.62
UC3	11.05	10.97	10.66
UC4	7.96	7.70	8.03
UC5	24.30	24.04	24.58
UC6	45.13	44.29	45.88

PPM and PPK Parameters: Final Values

A.26

When input into the SATURN models, the PPM and PPK values are given as a ratio, rather than absolute values. The final parameters for the 2016, 2021 and 2026 models are given in Table A.30, Table A.31 and Table A.32 respectively.

Table A.30 – 2016 PPM and PPK Parameters

User Class	Absolute Values (2002 prices)						Model Parameters					
	AM		IP		PM		AM		IP		PM	
	PPM	PPK	PPM	PPK	PPM	PPK	PPM	PPK	PPM	PPK	PPM	PPK
UC1	10.82	9.40	11.21	9.39	11.30	9.16	1.00	0.87	1.00	0.84	1.00	0.81
UC2	20.68	8.90	14.96	8.73	18.63	8.89	1.00	0.43	1.00	0.58	1.00	0.48
UC3	37.92	11.59	37.71	11.52	43.68	11.34	1.00	0.31	1.00	0.31	1.00	0.26
UC4	12.72	9.14	12.91	8.95	13.23	9.20	1.00	0.72	1.00	0.69	1.00	0.70
UC5	21.79	23.54	19.97	23.34	25.68	23.74	1.00	1.08	1.00	1.17	1.00	0.92
UC6	17.12	43.63	17.12	42.86	17.12	44.20	1.00	2.55	1.00	2.50	1.00	2.58

Table A.31 – 2021 PPM and PPK Parameters

User Class	Absolute Values (2002 prices)						Model Parameters					
	AM		IP		PM		AM		IP		PM	
	PPM	PPK	PPM	PPK	PPM	PPK	PPM	PPK	PPM	PPK	PPM	PPK
UC1	11.56	8.88	11.99	8.86	12.08	8.60	1.00	0.77	1.00	0.74	1.00	0.71
UC2	22.10	8.29	15.99	8.10	19.91	8.28	1.00	0.38	1.00	0.51	1.00	0.42
UC3	41.19	11.33	40.97	11.26	47.45	11.01	1.00	0.28	1.00	0.27	1.00	0.23
UC4	13.59	8.58	13.79	8.36	14.14	8.64	1.00	0.63	1.00	0.61	1.00	0.61
UC5	23.67	23.91	21.69	23.68	27.89	24.14	1.00	1.01	1.00	1.09	1.00	0.87
UC6	18.60	44.37	18.60	43.55	18.60	44.99	1.00	2.39	1.00	2.34	1.00	2.42

Table A.32 – 2026 PPM and PPK Parameters

User Class	Absolute Values (2002 prices)						Model Parameters					
	AM		IP		PM		AM		IP		PM	
	PPM	PPK	PPM	PPK	PPM	PPK	PPM	PPK	PPM	PPK	PPM	PPK
UC1	12.36	8.30	12.81	8.28	12.91	7.98	1.00	0.67	1.00	0.65	1.00	0.62
UC2	23.63	7.63	17.09	7.41	21.28	7.62	1.00	0.32	1.00	0.43	1.00	0.36
UC3	44.75	11.05	44.51	10.97	51.55	10.66	1.00	0.25	1.00	0.25	1.00	0.21
UC4	14.53	7.96	14.74	7.70	15.12	8.03	1.00	0.55	1.00	0.52	1.00	0.53
UC5	25.71	24.30	23.57	24.04	30.30	24.58	1.00	0.95	1.00	1.02	1.00	0.81
UC6	20.20	45.13	20.20	44.29	20.20	45.88	1.00	2.23	1.00	2.19	1.00	2.27

B. Sector to Sector Analysis



Sector to Sector Analysis

- B.1 The following table shows the sector to sector movements for the 2010 base year demand matrices and all forecast year demand matrices. These tables show the change in demand distribution between scenarios and forecast years.
- B.2 Figure B.1 and Figure B.2 show the MATS 8 sector system.

Figure B.1 – MATS Sector System (Overview)

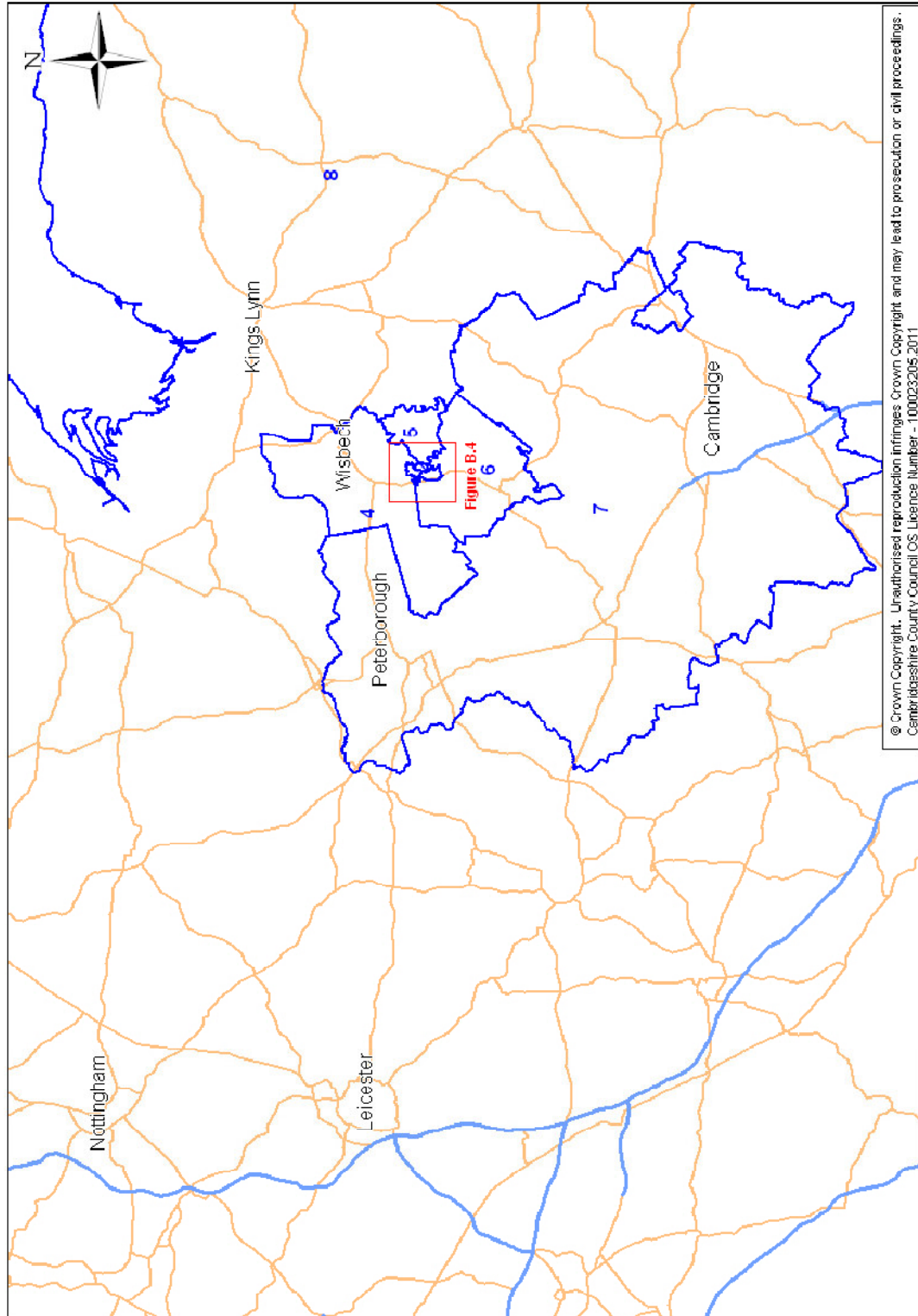
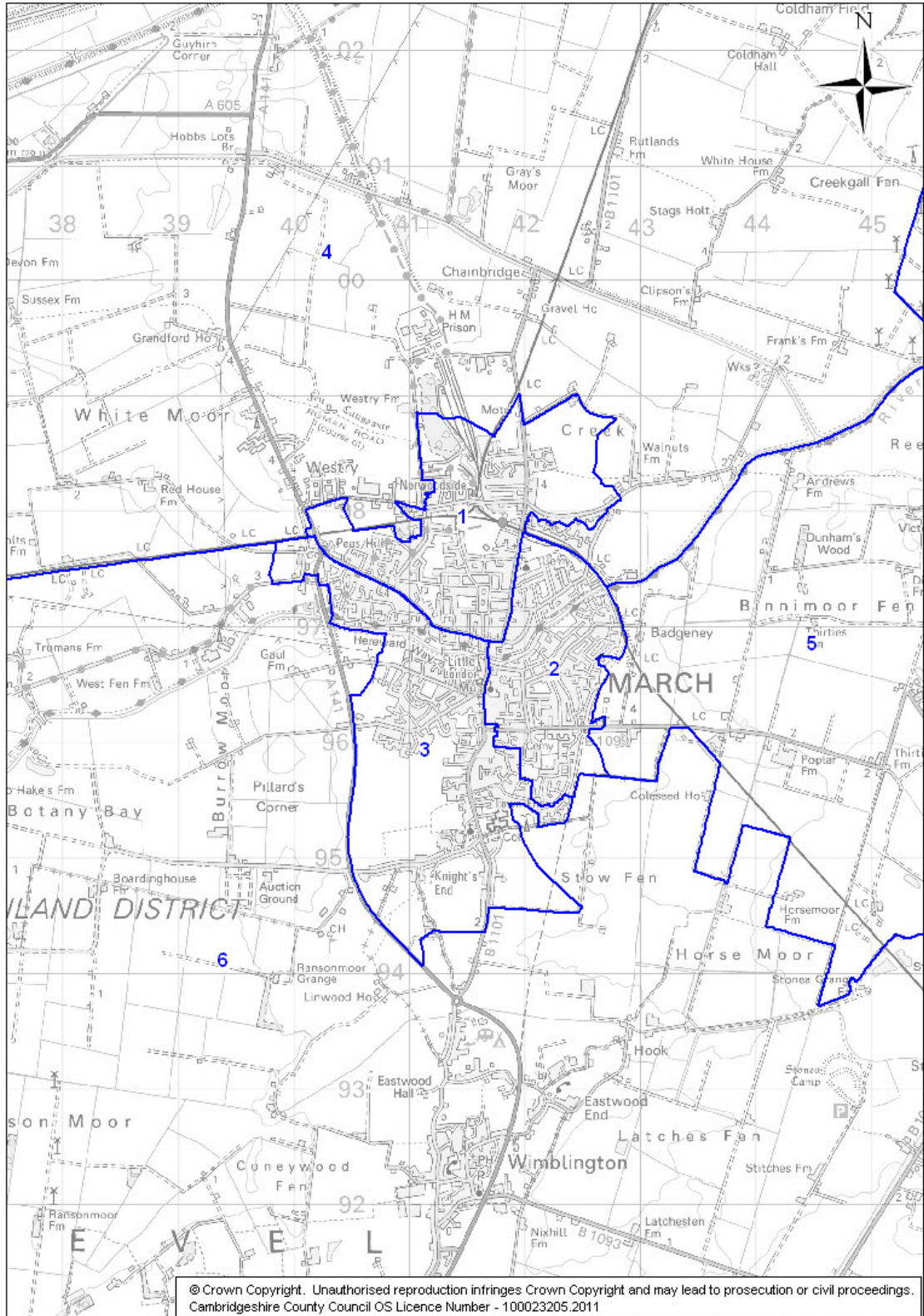

Figure B.1 – MATS Sector System



2010 Base Year

Table B.1 – 2010 Base Year (AM)

		Origin								TOT
		1	2	3	4	5	6	7	8	
Destination	1	314 (5%)	89 (1%)	192 (3%)	242 (4%)	11 (0%)	107 (2%)	192 (3%)	58 (1%)	1205 (19%)
	2	165 (3%)	148 (2%)	178 (3%)	129 (2%)	9 (0%)	56 (1%)	163 (3%)	94 (1%)	942 (15%)
	3	184 (3%)	107 (2%)	306 (5%)	200 (3%)	6 (0%)	138 (2%)	91 (1%)	87 (1%)	1119 (17%)
	4	196 (3%)	81 (1%)	110 (2%)	459 (7%)	9 (0%)	206 (3%)	141 (2%)	103 (2%)	1304 (20%)
	5	11 (0%)	9 (0%)	9 (0%)	7 (0%)	0 (0%)	8 (0%)	3 (0%)	3 (0%)	51 (1%)
	6	176 (3%)	74 (1%)	147 (2%)	220 (3%)	6 (0%)	95 (1%)	50 (1%)	80 (1%)	848 (13%)
	7	123 (2%)	39 (1%)	62 (1%)	115 (2%)	4 (0%)	44 (1%)	8 (0%)	45 (1%)	440 (7%)
	8	86 (1%)	68 (1%)	56 (1%)	119 (2%)	1 (0%)	81 (1%)	52 (1%)	46 (1%)	511 (8%)
	TOT	1255 (20%)	616 (10%)	1060 (17%)	1491 (23%)	47 (1%)	736 (11%)	700 (11%)	515 (8%)	6420 (100%)

Table B.2 – 2010 Base Year (IP)

		Origin								TOT
		1	2	3	4	5	6	7	8	
Destination	1	168 (3%)	169 (3%)	136 (3%)	240 (5%)	10 (0%)	87 (2%)	78 (1%)	51 (1%)	939 (18%)
	2	168 (3%)	94 (2%)	156 (3%)	122 (2%)	9 (0%)	85 (2%)	64 (1%)	54 (1%)	752 (14%)
	3	123 (2%)	127 (2%)	131 (2%)	130 (2%)	11 (0%)	179 (3%)	52 (1%)	55 (1%)	807 (15%)
	4	234 (4%)	108 (2%)	122 (2%)	397 (7%)	10 (0%)	208 (4%)	108 (2%)	84 (2%)	1271 (24%)
	5	10 (0%)	9 (0%)	11 (0%)	9 (0%)	1 (0%)	11 (0%)	3 (0%)	2 (0%)	55 (1%)
	6	80 (2%)	87 (2%)	167 (3%)	222 (4%)	11 (0%)	75 (1%)	44 (1%)	47 (1%)	733 (14%)
	7	79 (1%)	62 (1%)	52 (1%)	108 (2%)	3 (0%)	50 (1%)	11 (0%)	27 (1%)	393 (7%)
	8	54 (1%)	53 (1%)	55 (1%)	79 (1%)	2 (0%)	52 (1%)	27 (1%)	33 (1%)	355 (7%)
	TOT	917 (17%)	711 (13%)	829 (16%)	1306 (25%)	56 (1%)	747 (14%)	386 (7%)	353 (7%)	5306 (100%)

Table B.3 – 2010 Base Year (PM)

		Origin								TOT
		1	2	3	4	5	6	7	8	
Destination	1	182 (3%)	173 (3%)	227 (3%)	183 (3%)	4 (0%)	126 (2%)	114 (2%)	96 (1%)	1103 (16%)
	2	164 (2%)	200 (3%)	152 (2%)	82 (1%)	12 (0%)	112 (2%)	63 (1%)	103 (1%)	887 (13%)
	3	147 (2%)	156 (2%)	176 (3%)	98 (1%)	18 (0%)	218 (3%)	68 (1%)	78 (1%)	960 (14%)
	4	338 (5%)	102 (1%)	182 (3%)	506 (7%)	11 (0%)	350 (5%)	111 (2%)	99 (1%)	1699 (25%)
	5	9 (0%)	6 (0%)	12 (0%)	18 (0%)	0 (0%)	9 (0%)	7 (0%)	6 (0%)	68 (1%)
	6	82 (1%)	87 (1%)	181 (3%)	227 (3%)	9 (0%)	109 (2%)	36 (1%)	97 (1%)	828 (12%)
	7	170 (2%)	159 (2%)	139 (2%)	179 (3%)	3 (0%)	86 (1%)	6 (0%)	58 (1%)	799 (12%)
	8	72 (1%)	130 (2%)	109 (2%)	105 (2%)	4 (0%)	69 (1%)	40 (1%)	39 (1%)	568 (8%)
	TOT	1164 (17%)	1012 (15%)	1178 (17%)	1397 (20%)	60 (1%)	1079 (16%)	445 (6%)	576 (8%)	6912 (100%)

2016 Do Minimum

Table B.4 – 2016 Do Minimum (AM)

		Origin								TOT
		1	2	3	4	5	6	7	8	
Destination	1	358 (5%)	102 (1%)	225 (3%)	290 (4%)	13 (0%)	117 (2%)	210 (3%)	61 (1%)	1375 (19%)
	2	188 (3%)	164 (2%)	203 (3%)	152 (2%)	10 (0%)	61 (1%)	175 (2%)	102 (1%)	1053 (14%)
	3	229 (3%)	132 (2%)	380 (5%)	236 (3%)	8 (0%)	159 (2%)	102 (1%)	97 (1%)	1343 (18%)
	4	236 (3%)	95 (1%)	137 (2%)	544 (7%)	11 (0%)	257 (3%)	183 (2%)	132 (2%)	1595 (22%)
	5	12 (0%)	10 (0%)	10 (0%)	9 (0%)	0 (0%)	8 (0%)	4 (0%)	3 (0%)	55 (1%)
	6	185 (2%)	80 (1%)	174 (2%)	237 (3%)	6 (0%)	103 (1%)	45 (1%)	65 (1%)	895 (12%)
	7	140 (2%)	44 (1%)	71 (1%)	140 (2%)	5 (0%)	47 (1%)	9 (0%)	54 (1%)	511 (7%)
	8	96 (1%)	75 (1%)	61 (1%)	147 (2%)	1 (0%)	87 (1%)	60 (1%)	55 (1%)	582 (8%)
	TOT	1442 (19%)	701 (9%)	1261 (17%)	1756 (24%)	53 (1%)	839 (11%)	789 (11%)	570 (8%)	7410 (100%)

Table B.5 – 2016 Do Minimum (IP)

		Origin								TOT
		1	2	3	4	5	6	7	8	
Destination	1	188 (3%)	191 (3%)	151 (2%)	284 (5%)	11 (0%)	96 (2%)	81 (1%)	58 (1%)	1061 (17%)
	2	193 (3%)	106 (2%)	191 (3%)	142 (2%)	10 (0%)	99 (2%)	64 (1%)	62 (1%)	869 (14%)
	3	147 (2%)	152 (2%)	172 (3%)	161 (3%)	12 (0%)	218 (4%)	50 (1%)	62 (1%)	974 (16%)
	4	284 (5%)	126 (2%)	150 (2%)	468 (8%)	11 (0%)	240 (4%)	118 (2%)	95 (2%)	1492 (24%)
	5	11 (0%)	10 (0%)	12 (0%)	10 (0%)	1 (0%)	9 (0%)	4 (0%)	2 (0%)	58 (1%)
	6	87 (1%)	95 (2%)	189 (3%)	254 (4%)	9 (0%)	87 (1%)	46 (1%)	54 (1%)	821 (13%)
	7	90 (1%)	71 (1%)	60 (1%)	127 (2%)	4 (0%)	57 (1%)	14 (0%)	33 (1%)	455 (7%)
	8	62 (1%)	61 (1%)	63 (1%)	90 (1%)	2 (0%)	58 (1%)	28 (0%)	39 (1%)	403 (7%)
	TOT	1061 (17%)	812 (13%)	989 (16%)	1537 (25%)	60 (1%)	864 (14%)	404 (7%)	405 (7%)	6131 (100%)

Table B.6 – 2016 Do Minimum (PM)

		Origin								TOT
		1	2	3	4	5	6	7	8	
Destination	1	204 (3%)	199 (2%)	263 (3%)	227 (3%)	4 (0%)	127 (2%)	130 (2%)	107 (1%)	1261 (16%)
	2	189 (2%)	231 (3%)	191 (2%)	103 (1%)	12 (0%)	114 (1%)	63 (1%)	118 (1%)	1021 (13%)
	3	177 (2%)	190 (2%)	233 (3%)	126 (2%)	18 (0%)	230 (3%)	70 (1%)	91 (1%)	1135 (14%)
	4	420 (5%)	121 (2%)	243 (3%)	587 (7%)	15 (0%)	419 (5%)	116 (1%)	130 (2%)	2051 (26%)
	5	11 (0%)	6 (0%)	13 (0%)	24 (0%)	0 (0%)	7 (0%)	7 (0%)	3 (0%)	71 (1%)
	6	84 (1%)	83 (1%)	185 (2%)	279 (3%)	7 (0%)	92 (1%)	32 (0%)	97 (1%)	860 (11%)
	7	186 (2%)	179 (2%)	152 (2%)	252 (3%)	4 (0%)	82 (1%)	7 (0%)	65 (1%)	927 (12%)
	8	80 (1%)	146 (2%)	120 (2%)	139 (2%)	4 (0%)	66 (1%)	46 (1%)	45 (1%)	647 (8%)
	TOT	1352 (17%)	1155 (14%)	1401 (18%)	1735 (22%)	64 (1%)	1139 (14%)	470 (6%)	656 (8%)	7973 (100%)

2021 Do Minimum

Table B.7 – 2021 Do Minimum (AM)

		Origin								TOT
		1	2	3	4	5	6	7	8	
Destination	1	385 (5%)	112 (1%)	245 (3%)	312 (4%)	14 (0%)	127 (2%)	226 (3%)	65 (1%)	1486 (19%)
	2	204 (3%)	178 (2%)	219 (3%)	164 (2%)	10 (0%)	66 (1%)	188 (2%)	110 (1%)	1140 (14%)
	3	249 (3%)	143 (2%)	411 (5%)	254 (3%)	8 (0%)	172 (2%)	110 (1%)	105 (1%)	1451 (18%)
	4	252 (3%)	102 (1%)	147 (2%)	586 (7%)	12 (0%)	278 (3%)	197 (2%)	141 (2%)	1715 (21%)
	5	13 (0%)	10 (0%)	11 (0%)	10 (0%)	0 (0%)	8 (0%)	4 (0%)	4 (0%)	60 (1%)
	6	200 (3%)	86 (1%)	187 (2%)	255 (3%)	6 (0%)	111 (1%)	49 (1%)	70 (1%)	963 (12%)
	7	150 (2%)	48 (1%)	77 (1%)	152 (2%)	5 (0%)	51 (1%)	10 (0%)	59 (1%)	551 (7%)
	8	102 (1%)	80 (1%)	65 (1%)	157 (2%)	1 (0%)	93 (1%)	65 (1%)	59 (1%)	623 (8%)
	TOT	1554 (19%)	758 (9%)	1362 (17%)	1890 (24%)	57 (1%)	907 (11%)	850 (11%)	612 (8%)	7990 (100%)

Table B.8 – 2021 Do Minimum (IP)

		Origin								TOT
		1	2	3	4	5	6	7	8	
Destination	1	205 (3%)	211 (3%)	167 (2%)	310 (5%)	12 (0%)	105 (2%)	88 (1%)	62 (1%)	1160 (17%)
	2	213 (3%)	117 (2%)	210 (3%)	155 (2%)	11 (0%)	108 (2%)	70 (1%)	66 (1%)	952 (14%)
	3	162 (2%)	167 (2%)	190 (3%)	176 (3%)	13 (0%)	240 (4%)	54 (1%)	67 (1%)	1069 (16%)
	4	310 (5%)	137 (2%)	164 (2%)	510 (8%)	12 (0%)	261 (4%)	128 (2%)	102 (2%)	1624 (24%)
	5	12 (0%)	11 (0%)	13 (0%)	11 (0%)	1 (0%)	10 (0%)	4 (0%)	2 (0%)	63 (1%)
	6	95 (1%)	104 (2%)	208 (3%)	276 (4%)	10 (0%)	94 (1%)	50 (1%)	58 (1%)	895 (13%)
	7	98 (1%)	77 (1%)	65 (1%)	138 (2%)	4 (0%)	62 (1%)	15 (0%)	36 (1%)	494 (7%)
	8	66 (1%)	66 (1%)	68 (1%)	97 (1%)	2 (0%)	62 (1%)	30 (0%)	42 (1%)	433 (6%)
	TOT	1161 (17%)	891 (13%)	1085 (16%)	1673 (25%)	66 (1%)	942 (14%)	439 (7%)	435 (6%)	6691 (100%)

Table B.9 – 2021 Do Minimum (PM)

		Origin								TOT
		1	2	3	4	5	6	7	8	
Destination	1	229 (3%)	219 (3%)	287 (3%)	245 (3%)	4 (0%)	137 (2%)	139 (2%)	115 (1%)	1375 (16%)
	2	208 (2%)	255 (3%)	208 (2%)	112 (1%)	13 (0%)	125 (1%)	69 (1%)	127 (1%)	1118 (13%)
	3	193 (2%)	208 (2%)	255 (3%)	137 (2%)	20 (0%)	251 (3%)	76 (1%)	98 (1%)	1238 (14%)
	4	454 (5%)	131 (2%)	263 (3%)	636 (7%)	16 (0%)	451 (5%)	126 (1%)	139 (2%)	2217 (26%)
	5	12 (0%)	6 (0%)	14 (0%)	26 (0%)	0 (0%)	8 (0%)	7 (0%)	3 (0%)	77 (1%)
	6	90 (1%)	90 (1%)	202 (2%)	302 (3%)	8 (0%)	100 (1%)	35 (0%)	105 (1%)	931 (11%)
	7	199 (2%)	194 (2%)	165 (2%)	273 (3%)	4 (0%)	89 (1%)	8 (0%)	70 (1%)	1002 (12%)
	8	85 (1%)	157 (2%)	129 (1%)	149 (2%)	5 (0%)	71 (1%)	50 (1%)	48 (1%)	692 (8%)
	TOT	1471 (17%)	1259 (15%)	1525 (18%)	1880 (22%)	70 (1%)	1232 (14%)	510 (6%)	704 (8%)	8650 (100%)

2026 Do Minimum

Table B.10 – 2026 Do Minimum (AM)

		Origin								TOT
		1	2	3	4	5	6	7	8	
Destination	1	416 (5%)	123 (1%)	269 (3%)	336 (4%)	15 (0%)	138 (2%)	243 (3%)	69 (1%)	1610 (19%)
	2	222 (3%)	194 (2%)	238 (3%)	179 (2%)	11 (0%)	72 (1%)	201 (2%)	118 (1%)	1235 (14%)
	3	271 (3%)	155 (2%)	446 (5%)	274 (3%)	9 (0%)	188 (2%)	118 (1%)	112 (1%)	1572 (18%)
	4	269 (3%)	111 (1%)	159 (2%)	630 (7%)	13 (0%)	299 (3%)	211 (2%)	150 (2%)	1843 (21%)
	5	14 (0%)	11 (0%)	11 (0%)	11 (0%)	0 (0%)	9 (0%)	5 (0%)	4 (0%)	64 (1%)
	6	216 (3%)	93 (1%)	202 (2%)	274 (3%)	7 (0%)	119 (1%)	52 (1%)	74 (1%)	1036 (12%)
	7	162 (2%)	52 (1%)	82 (1%)	163 (2%)	5 (0%)	55 (1%)	11 (0%)	63 (1%)	594 (7%)
	8	109 (1%)	85 (1%)	70 (1%)	168 (2%)	1 (0%)	100 (1%)	70 (1%)	63 (1%)	666 (8%)
	TOT	1680 (19%)	823 (10%)	1477 (17%)	2034 (24%)	62 (1%)	980 (11%)	911 (11%)	653 (8%)	8619 (100%)

Table B.11 – 2026 Do Minimum (IP)

		Origin								TOT
		1	2	3	4	5	6	7	8	
Destination	1	225 (3%)	234 (3%)	184 (3%)	339 (5%)	13 (0%)	115 (2%)	96 (1%)	67 (1%)	1274 (17%)
	2	237 (3%)	130 (2%)	232 (3%)	170 (2%)	12 (0%)	119 (2%)	76 (1%)	72 (1%)	1047 (14%)
	3	179 (2%)	184 (3%)	210 (3%)	194 (3%)	15 (0%)	265 (4%)	59 (1%)	72 (1%)	1178 (16%)
	4	339 (5%)	150 (2%)	179 (2%)	558 (8%)	13 (0%)	283 (4%)	138 (2%)	109 (1%)	1771 (24%)
	5	13 (0%)	12 (0%)	14 (0%)	12 (0%)	1 (0%)	11 (0%)	4 (0%)	2 (0%)	69 (1%)
	6	105 (1%)	114 (2%)	230 (3%)	299 (4%)	10 (0%)	103 (1%)	54 (1%)	62 (1%)	977 (13%)
	7	106 (1%)	84 (1%)	71 (1%)	149 (2%)	4 (0%)	67 (1%)	17 (0%)	38 (1%)	537 (7%)
	8	71 (1%)	71 (1%)	73 (1%)	104 (1%)	2 (0%)	66 (1%)	32 (0%)	44 (1%)	463 (6%)
	TOT	1275 (17%)	979 (13%)	1194 (16%)	1825 (25%)	72 (1%)	1029 (14%)	476 (7%)	466 (6%)	7317 (100%)

Table B.12 – 2026 Do Minimum (PM)

		Origin								TOT
		1	2	3	4	5	6	7	8	
Destination	1	250 (3%)	242 (3%)	316 (3%)	267 (3%)	4 (0%)	149 (2%)	150 (2%)	122 (1%)	1500 (16%)
	2	230 (2%)	284 (3%)	230 (2%)	123 (1%)	14 (0%)	124 (1%)	83 (1%)	140 (1%)	1228 (13%)
	3	214 (2%)	228 (2%)	281 (3%)	151 (2%)	21 (0%)	273 (3%)	78 (1%)	109 (1%)	1356 (14%)
	4	495 (5%)	143 (2%)	291 (3%)	693 (7%)	16 (0%)	476 (5%)	129 (1%)	157 (2%)	2400 (26%)
	5	13 (0%)	7 (0%)	16 (0%)	7 (0%)	0 (0%)	30 (0%)	8 (0%)	3 (0%)	83 (1%)
	6	99 (1%)	97 (1%)	221 (2%)	345 (4%)	10 (0%)	103 (1%)	41 (0%)	96 (1%)	1012 (11%)
	7	213 (2%)	210 (2%)	175 (2%)	296 (3%)	4 (0%)	101 (1%)	9 (0%)	74 (1%)	1081 (12%)
	8	91 (1%)	168 (2%)	136 (1%)	156 (2%)	5 (0%)	79 (1%)	54 (1%)	50 (1%)	740 (8%)
	TOT	1605 (17%)	1378 (15%)	1664 (18%)	2038 (22%)	76 (1%)	1335 (14%)	551 (6%)	753 (8%)	9400 (100%)

2016 Do Something Test 1

Table B.13 – 2016 Do Something Test 1 (AM)

		Origin								TOT
		1	2	3	4	5	6	7	8	
Destination	1	350 (5%)	78 (1%)	305 (4%)	267 (4%)	12 (0%)	109 (1%)	193 (3%)	56 (1%)	1369 (18%)
	2	163 (2%)	123 (2%)	233 (3%)	128 (2%)	9 (0%)	52 (1%)	147 (2%)	90 (1%)	946 (13%)
	3	307 (4%)	109 (1%)	512 (7%)	203 (3%)	8 (0%)	144 (2%)	95 (1%)	83 (1%)	1461 (20%)
	4	205 (3%)	70 (1%)	133 (2%)	564 (8%)	11 (0%)	269 (4%)	203 (3%)	140 (2%)	1595 (22%)
	5	10 (0%)	6 (0%)	11 (0%)	10 (0%)	0 (0%)	8 (0%)	5 (0%)	4 (0%)	55 (1%)
	6	159 (2%)	64 (1%)	164 (2%)	262 (4%)	6 (0%)	111 (1%)	59 (1%)	72 (1%)	896 (12%)
	7	120 (2%)	37 (0%)	61 (1%)	158 (2%)	5 (0%)	55 (1%)	13 (0%)	62 (1%)	511 (7%)
	8	79 (1%)	57 (1%)	51 (1%)	164 (2%)	2 (0%)	92 (1%)	74 (1%)	63 (1%)	582 (8%)
	TOT	1393 (19%)	544 (7%)	1470 (20%)	1756 (24%)	53 (1%)	840 (11%)	789 (11%)	570 (8%)	7415 (100%)

Table B.14 – 2016 Do Something Test 1 (IP)

		Origin								TOT
		1	2	3	4	5	6	7	8	
Destination	1	185 (3%)	164 (3%)	206 (3%)	265 (4%)	11 (0%)	90 (1%)	76 (1%)	55 (1%)	1052 (17%)
	2	166 (3%)	82 (1%)	180 (3%)	128 (2%)	10 (0%)	93 (2%)	58 (1%)	55 (1%)	772 (13%)
	3	200 (3%)	147 (2%)	262 (4%)	152 (2%)	12 (0%)	206 (3%)	46 (1%)	58 (1%)	1083 (18%)
	4	265 (4%)	110 (2%)	144 (2%)	487 (8%)	12 (0%)	253 (4%)	124 (2%)	97 (2%)	1492 (24%)
	5	10 (0%)	9 (0%)	12 (0%)	11 (0%)	1 (0%)	10 (0%)	4 (0%)	2 (0%)	58 (1%)
	6	81 (1%)	87 (1%)	181 (3%)	268 (4%)	9 (0%)	90 (1%)	49 (1%)	57 (1%)	821 (13%)
	7	84 (1%)	63 (1%)	56 (1%)	135 (2%)	4 (0%)	61 (1%)	16 (0%)	37 (1%)	455 (7%)
	8	58 (1%)	54 (1%)	61 (1%)	92 (2%)	2 (0%)	61 (1%)	31 (1%)	44 (1%)	403 (7%)
	TOT	1049 (17%)	715 (12%)	1101 (18%)	1537 (25%)	60 (1%)	865 (14%)	404 (7%)	405 (7%)	6135 (100%)

Table B.15 – 2016 Do Something Test 1 (PM)

		Origin								TOT
		1	2	3	4	5	6	7	8	
Destination	1	234 (3%)	183 (2%)	293 (4%)	202 (3%)	4 (0%)	115 (1%)	120 (2%)	96 (1%)	1247 (16%)
	2	141 (2%)	176 (2%)	149 (2%)	80 (1%)	10 (0%)	97 (1%)	56 (1%)	101 (1%)	810 (10%)
	3	238 (3%)	225 (3%)	391 (5%)	127 (2%)	18 (0%)	210 (3%)	65 (1%)	90 (1%)	1364 (17%)
	4	389 (5%)	107 (1%)	223 (3%)	600 (8%)	16 (0%)	450 (6%)	126 (2%)	141 (2%)	2052 (26%)
	5	9 (0%)	6 (0%)	15 (0%)	24 (0%)	0 (0%)	7 (0%)	6 (0%)	4 (0%)	71 (1%)
	6	79 (1%)	78 (1%)	170 (2%)	291 (4%)	8 (0%)	94 (1%)	37 (0%)	102 (1%)	859 (11%)
	7	171 (2%)	162 (2%)	145 (2%)	269 (3%)	4 (0%)	93 (1%)	9 (0%)	73 (1%)	927 (12%)
	8	79 (1%)	134 (2%)	113 (1%)	142 (2%)	5 (0%)	73 (1%)	51 (1%)	49 (1%)	646 (8%)
	TOT	1340 (17%)	1070 (13%)	1498 (19%)	1736 (22%)	64 (1%)	1139 (14%)	471 (6%)	656 (8%)	7975 (100%)

2021 Do Something Test 1

Table B.16 – 2021 Do Something Test 1 (AM)

		Origin								
		1	2	3	4	5	6	7	8	TOT
Destination	1	327 (4%)	61 (1%)	466 (6%)	259 (3%)	11 (0%)	106 (1%)	186 (2%)	54 (1%)	1470 (18%)
	2	137 (2%)	103 (1%)	271 (3%)	117 (1%)	9 (0%)	48 (1%)	132 (2%)	85 (1%)	902 (11%)
	3	472 (6%)	104 (1%)	601 (8%)	197 (2%)	11 (0%)	153 (2%)	91 (1%)	75 (1%)	1704 (21%)
	4	182 (2%)	54 (1%)	151 (2%)	622 (8%)	13 (0%)	296 (4%)	238 (3%)	159 (2%)	1714 (21%)
	5	9 (0%)	4 (0%)	15 (0%)	12 (0%)	0 (0%)	9 (0%)	6 (0%)	5 (0%)	60 (1%)
	6	140 (2%)	53 (1%)	171 (2%)	303 (4%)	7 (0%)	126 (2%)	81 (1%)	82 (1%)	963 (12%)
	7	107 (1%)	31 (0%)	56 (1%)	189 (2%)	6 (0%)	66 (1%)	20 (0%)	76 (1%)	551 (7%)
	8	65 (1%)	44 (1%)	43 (1%)	193 (2%)	2 (0%)	103 (1%)	97 (1%)	76 (1%)	623 (8%)
	TOT	1440 (18%)	455 (6%)	1775 (22%)	1891 (24%)	57 (1%)	907 (11%)	851 (11%)	612 (8%)	7988 (100%)

Table B.17 – 2021 Do Something Test 1 (IP)

		Origin								
		1	2	3	4	5	6	7	8	TOT
Destination	1	177 (3%)	149 (2%)	311 (5%)	269 (4%)	11 (0%)	92 (1%)	77 (1%)	55 (1%)	1142 (17%)
	2	150 (2%)	70 (1%)	192 (3%)	124 (2%)	9 (0%)	94 (1%)	57 (1%)	54 (1%)	750 (11%)
	3	311 (5%)	160 (2%)	330 (5%)	159 (2%)	13 (0%)	214 (3%)	47 (1%)	59 (1%)	1293 (19%)
	4	266 (4%)	104 (2%)	153 (2%)	550 (8%)	14 (0%)	289 (4%)	141 (2%)	106 (2%)	1624 (24%)
	5	10 (0%)	9 (0%)	14 (0%)	12 (0%)	1 (0%)	11 (0%)	4 (0%)	2 (0%)	63 (1%)
	6	82 (1%)	87 (1%)	190 (3%)	305 (5%)	10 (0%)	102 (2%)	56 (1%)	63 (1%)	895 (13%)
	7	84 (1%)	60 (1%)	58 (1%)	153 (2%)	5 (0%)	71 (1%)	20 (0%)	44 (1%)	495 (7%)
	8	57 (1%)	51 (1%)	63 (1%)	102 (2%)	2 (0%)	69 (1%)	37 (1%)	51 (1%)	433 (6%)
	TOT	1137 (17%)	691 (10%)	1311 (20%)	1674 (25%)	66 (1%)	943 (14%)	439 (7%)	435 (6%)	6696 (100%)

Table B.18 – 2021 Do Something Test 1 (PM)

		Origin								
		1	2	3	4	5	6	7	8	TOT
Destination	1	249 (3%)	172 (2%)	400 (5%)	194 (2%)	4 (0%)	111 (1%)	119 (1%)	91 (1%)	1340 (15%)
	2	114 (1%)	142 (2%)	139 (2%)	68 (1%)	8 (0%)	89 (1%)	54 (1%)	93 (1%)	707 (8%)
	3	362 (4%)	281 (3%)	519 (6%)	142 (2%)	20 (0%)	202 (2%)	65 (1%)	89 (1%)	1681 (19%)
	4	386 (4%)	102 (1%)	225 (3%)	661 (8%)	18 (0%)	518 (6%)	146 (2%)	163 (2%)	2220 (26%)
	5	8 (0%)	6 (0%)	17 (0%)	27 (0%)	0 (0%)	8 (0%)	7 (0%)	4 (0%)	77 (1%)
	6	80 (1%)	78 (1%)	174 (2%)	324 (4%)	8 (0%)	105 (1%)	46 (1%)	116 (1%)	933 (11%)
	7	169 (2%)	154 (2%)	149 (2%)	307 (4%)	6 (0%)	116 (1%)	12 (0%)	89 (1%)	1003 (12%)
	8	82 (1%)	131 (2%)	114 (1%)	156 (2%)	6 (0%)	84 (1%)	60 (1%)	58 (1%)	693 (8%)
	TOT	1452 (17%)	1066 (12%)	1738 (20%)	1880 (22%)	70 (1%)	1233 (14%)	510 (6%)	704 (8%)	8654 (100%)

2026 Do Something Test 1

Table B.19 – 2026 Do Something Test 1 (AM)

		Origin								TOT
		1	2	3	4	5	6	7	8	
Destination	1	326 (4%)	50 (1%)	602 (7%)	260 (3%)	11 (0%)	107 (1%)	182 (2%)	53 (1%)	1589 (18%)
	2	129 (1%)	94 (1%)	321 (4%)	112 (1%)	9 (0%)	48 (1%)	122 (1%)	83 (1%)	917 (11%)
	3	619 (7%)	90 (1%)	662 (8%)	200 (2%)	13 (0%)	165 (2%)	90 (1%)	73 (1%)	1911 (22%)
	4	166 (2%)	43 (0%)	183 (2%)	676 (8%)	14 (0%)	322 (4%)	266 (3%)	172 (2%)	1842 (21%)
	5	8 (0%)	3 (0%)	21 (0%)	13 (0%)	0 (0%)	9 (0%)	7 (0%)	5 (0%)	64 (1%)
	6	124 (1%)	44 (1%)	195 (2%)	335 (4%)	7 (0%)	140 (2%)	100 (1%)	90 (1%)	1035 (12%)
	7	92 (1%)	26 (0%)	56 (1%)	218 (3%)	6 (0%)	77 (1%)	28 (0%)	90 (1%)	593 (7%)
	8	53 (1%)	33 (0%)	38 (0%)	221 (3%)	2 (0%)	112 (1%)	117 (1%)	89 (1%)	665 (8%)
	TOT	1516 (18%)	383 (4%)	2077 (24%)	2035 (24%)	62 (1%)	980 (11%)	911 (11%)	653 (8%)	8618 (100%)

Table B.20 – 2026 Do Something Test 1 (IP)

		Origin								TOT
		1	2	3	4	5	6	7	8	
Destination	1	176 (2%)	146 (2%)	405 (6%)	279 (4%)	11 (0%)	96 (1%)	80 (1%)	57 (1%)	1249 (17%)
	2	146 (2%)	67 (1%)	207 (3%)	126 (2%)	10 (0%)	97 (1%)	57 (1%)	53 (1%)	762 (10%)
	3	410 (6%)	175 (2%)	374 (5%)	173 (2%)	15 (0%)	231 (3%)	49 (1%)	62 (1%)	1491 (20%)
	4	275 (4%)	103 (1%)	169 (2%)	613 (8%)	15 (0%)	323 (4%)	157 (2%)	116 (2%)	1771 (24%)
	5	11 (0%)	9 (0%)	16 (0%)	14 (0%)	1 (0%)	12 (0%)	5 (0%)	2 (0%)	69 (1%)
	6	85 (1%)	89 (1%)	208 (3%)	340 (5%)	11 (0%)	113 (2%)	63 (1%)	69 (1%)	978 (13%)
	7	85 (1%)	60 (1%)	62 (1%)	170 (2%)	5 (0%)	81 (1%)	23 (0%)	51 (1%)	537 (7%)
	8	58 (1%)	50 (1%)	67 (1%)	111 (2%)	2 (0%)	76 (1%)	42 (1%)	57 (1%)	464 (6%)
	TOT	1244 (17%)	699 (10%)	1508 (21%)	1826 (25%)	72 (1%)	1030 (14%)	476 (7%)	466 (6%)	7321 (100%)

Table B.21 – 2026 Do Something Test 1 (PM)

		Origin								TOT
		1	2	3	4	5	6	7	8	
Destination	1	274 (3%)	176 (2%)	491 (5%)	194 (2%)	5 (0%)	109 (1%)	119 (1%)	89 (1%)	1458 (16%)
	2	95 (1%)	119 (1%)	133 (1%)	61 (1%)	7 (0%)	83 (1%)	52 (1%)	86 (1%)	636 (7%)
	3	470 (5%)	346 (4%)	616 (7%)	165 (2%)	22 (0%)	208 (2%)	68 (1%)	90 (1%)	1987 (21%)
	4	396 (4%)	103 (1%)	235 (2%)	723 (8%)	19 (0%)	580 (6%)	165 (2%)	183 (2%)	2404 (26%)
	5	7 (0%)	6 (0%)	19 (0%)	30 (0%)	0 (0%)	9 (0%)	8 (0%)	5 (0%)	84 (1%)
	6	82 (1%)	81 (1%)	184 (2%)	356 (4%)	9 (0%)	116 (1%)	56 (1%)	130 (1%)	1013 (11%)
	7	172 (2%)	152 (2%)	156 (2%)	341 (4%)	6 (0%)	136 (1%)	15 (0%)	104 (1%)	1082 (12%)
	8	86 (1%)	132 (1%)	118 (1%)	169 (2%)	6 (0%)	95 (1%)	69 (1%)	66 (1%)	740 (8%)
	TOT	1582 (17%)	1116 (12%)	1952 (21%)	2038 (22%)	76 (1%)	1336 (14%)	551 (6%)	753 (8%)	9403 (100%)

2021 Do Something Test 2

Table B.22 – 2021 Do Something Test 2 (AM)

		Origin								
		1	2	3	4	5	6	7	8	TOT
Destination	1	327 (4%)	61 (1%)	467 (6%)	259 (3%)	11 (0%)	107 (1%)	186 (2%)	54 (1%)	1471 (18%)
	2	137 (2%)	103 (1%)	272 (3%)	117 (1%)	9 (0%)	49 (1%)	132 (2%)	85 (1%)	905 (11%)
	3	474 (6%)	106 (1%)	605 (8%)	198 (2%)	11 (0%)	156 (2%)	91 (1%)	75 (1%)	1717 (21%)
	4	182 (2%)	54 (1%)	151 (2%)	622 (8%)	13 (0%)	297 (4%)	238 (3%)	159 (2%)	1715 (21%)
	5	9 (0%)	4 (0%)	15 (0%)	12 (0%)	0 (0%)	9 (0%)	6 (0%)	5 (0%)	60 (1%)
	6	142 (2%)	55 (1%)	176 (2%)	303 (4%)	7 (0%)	126 (2%)	81 (1%)	82 (1%)	973 (12%)
	7	107 (1%)	31 (0%)	56 (1%)	189 (2%)	6 (0%)	66 (1%)	20 (0%)	76 (1%)	551 (7%)
	8	65 (1%)	44 (1%)	43 (1%)	193 (2%)	2 (0%)	103 (1%)	97 (1%)	76 (1%)	623 (8%)
	TOT	1443 (18%)	459 (6%)	1787 (22%)	1893 (24%)	58 (1%)	913 (11%)	851 (11%)	612 (8%)	8015 (100%)

Table B.23 – 2021 Do Something Test 2 (IP)

		Origin								
		1	2	3	4	5	6	7	8	TOT
Destination	1	177 (3%)	149 (2%)	312 (5%)	269 (4%)	11 (0%)	92 (1%)	77 (1%)	55 (1%)	1143 (17%)
	2	150 (2%)	70 (1%)	193 (3%)	124 (2%)	9 (0%)	95 (1%)	57 (1%)	54 (1%)	753 (11%)
	3	312 (5%)	161 (2%)	334 (5%)	159 (2%)	14 (0%)	217 (3%)	47 (1%)	59 (1%)	1302 (19%)
	4	266 (4%)	104 (2%)	154 (2%)	550 (8%)	14 (0%)	290 (4%)	141 (2%)	106 (2%)	1625 (24%)
	5	10 (0%)	9 (0%)	14 (0%)	12 (0%)	1 (0%)	11 (0%)	4 (0%)	2 (0%)	64 (1%)
	6	82 (1%)	88 (1%)	193 (3%)	305 (5%)	11 (0%)	102 (2%)	56 (1%)	63 (1%)	901 (13%)
	7	84 (1%)	60 (1%)	58 (1%)	153 (2%)	5 (0%)	71 (1%)	20 (0%)	44 (1%)	495 (7%)
	8	57 (1%)	51 (1%)	63 (1%)	102 (2%)	2 (0%)	69 (1%)	37 (1%)	51 (1%)	433 (6%)
	TOT	1139 (17%)	693 (10%)	1320 (20%)	1675 (25%)	66 (1%)	949 (14%)	439 (7%)	435 (6%)	6716 (100%)

Table B.24 – 2021 Do Something Test 2 (PM)

		Origin								
		1	2	3	4	5	6	7	8	TOT
Destination	1	249 (3%)	172 (2%)	402 (5%)	194 (2%)	4 (0%)	112 (1%)	119 (1%)	91 (1%)	1343 (15%)
	2	114 (1%)	142 (2%)	141 (2%)	68 (1%)	8 (0%)	91 (1%)	54 (1%)	93 (1%)	711 (8%)
	3	363 (4%)	282 (3%)	524 (6%)	142 (2%)	20 (0%)	206 (2%)	65 (1%)	89 (1%)	1693 (20%)
	4	386 (4%)	102 (1%)	226 (3%)	661 (8%)	18 (0%)	519 (6%)	146 (2%)	163 (2%)	2222 (26%)
	5	8 (0%)	6 (0%)	18 (0%)	27 (0%)	0 (0%)	8 (0%)	7 (0%)	4 (0%)	78 (1%)
	6	81 (1%)	79 (1%)	178 (2%)	325 (4%)	9 (0%)	105 (1%)	47 (1%)	116 (1%)	939 (11%)
	7	169 (2%)	154 (2%)	149 (2%)	307 (4%)	6 (0%)	116 (1%)	12 (0%)	89 (1%)	1003 (12%)
	8	82 (1%)	131 (2%)	115 (1%)	156 (2%)	6 (0%)	85 (1%)	60 (1%)	58 (1%)	693 (8%)
	TOT	1454 (17%)	1068 (12%)	1751 (20%)	1881 (22%)	70 (1%)	1242 (14%)	510 (6%)	705 (8%)	8681 (100%)

2026 Do Something Test 2

Table B.25 – 2026 Do Something Test 2 (AM)

		Origin								TOT
		1	2	3	4	5	6	7	8	
Destination	1	326 (4%)	50 (1%)	613 (7%)	260 (3%)	11 (0%)	117 (1%)	182 (2%)	53 (1%)	1612 (18%)
	2	129 (1%)	94 (1%)	338 (4%)	112 (1%)	9 (0%)	64 (1%)	122 (1%)	83 (1%)	949 (11%)
	3	644 (7%)	125 (1%)	733 (8%)	215 (2%)	21 (0%)	206 (2%)	90 (1%)	73 (1%)	2106 (23%)
	4	166 (2%)	43 (0%)	190 (2%)	676 (7%)	14 (0%)	328 (4%)	266 (3%)	172 (2%)	1855 (21%)
	5	8 (0%)	3 (0%)	24 (0%)	13 (0%)	0 (0%)	12 (0%)	7 (0%)	5 (0%)	71 (1%)
	6	147 (2%)	77 (1%)	261 (3%)	347 (4%)	14 (0%)	150 (2%)	101 (1%)	90 (1%)	1187 (13%)
	7	92 (1%)	26 (0%)	57 (1%)	218 (2%)	6 (0%)	78 (1%)	28 (0%)	90 (1%)	594 (7%)
	8	53 (1%)	33 (0%)	39 (0%)	221 (2%)	2 (0%)	112 (1%)	117 (1%)	89 (1%)	666 (7%)
	TOT	1563 (17%)	450 (5%)	2254 (25%)	2062 (23%)	77 (1%)	1067 (12%)	913 (10%)	654 (7%)	9040 (100%)

Table B.26 – 2026 Do Something Test 2 (IP)

		Origin								TOT
		1	2	3	4	5	6	7	8	
Destination	1	176 (2%)	146 (2%)	418 (5%)	279 (4%)	11 (0%)	107 (1%)	80 (1%)	57 (1%)	1274 (17%)
	2	146 (2%)	67 (1%)	226 (3%)	126 (2%)	10 (0%)	115 (2%)	57 (1%)	53 (1%)	799 (10%)
	3	423 (6%)	193 (3%)	429 (6%)	180 (2%)	19 (0%)	274 (4%)	50 (1%)	62 (1%)	1631 (21%)
	4	275 (4%)	103 (1%)	177 (2%)	613 (8%)	15 (0%)	330 (4%)	157 (2%)	116 (2%)	1785 (23%)
	5	11 (0%)	9 (0%)	20 (0%)	14 (0%)	1 (0%)	15 (0%)	5 (0%)	2 (0%)	77 (1%)
	6	96 (1%)	106 (1%)	248 (3%)	346 (5%)	14 (0%)	120 (2%)	63 (1%)	70 (1%)	1064 (14%)
	7	85 (1%)	60 (1%)	63 (1%)	170 (2%)	5 (0%)	82 (1%)	23 (0%)	51 (1%)	538 (7%)
	8	58 (1%)	50 (1%)	68 (1%)	111 (1%)	2 (0%)	77 (1%)	42 (1%)	57 (1%)	465 (6%)
	TOT	1268 (17%)	734 (10%)	1648 (22%)	1839 (24%)	79 (1%)	1119 (15%)	477 (6%)	467 (6%)	7632 (100%)

Table B.27 – 2026 Do Something Test 2 (PM)

		Origin								TOT
		1	2	3	4	5	6	7	8	
Destination	1	274 (3%)	176 (2%)	512 (5%)	194 (2%)	5 (0%)	128 (1%)	119 (1%)	89 (1%)	1498 (15%)
	2	95 (1%)	119 (1%)	162 (2%)	61 (1%)	7 (0%)	111 (1%)	52 (1%)	86 (1%)	693 (7%)
	3	483 (5%)	365 (4%)	689 (7%)	172 (2%)	26 (0%)	270 (3%)	69 (1%)	92 (1%)	2166 (22%)
	4	396 (4%)	103 (1%)	248 (3%)	723 (7%)	19 (0%)	591 (6%)	165 (2%)	183 (2%)	2427 (25%)
	5	7 (0%)	6 (0%)	26 (0%)	30 (0%)	0 (0%)	15 (0%)	8 (0%)	5 (0%)	97 (1%)
	6	93 (1%)	98 (1%)	234 (2%)	361 (4%)	12 (0%)	125 (1%)	56 (1%)	132 (1%)	1111 (11%)
	7	172 (2%)	152 (2%)	157 (2%)	341 (3%)	6 (0%)	137 (1%)	15 (0%)	104 (1%)	1084 (11%)
	8	86 (1%)	132 (1%)	122 (1%)	169 (2%)	6 (0%)	98 (1%)	69 (1%)	66 (1%)	747 (8%)
	TOT	1606 (16%)	1151 (12%)	2151 (22%)	2050 (21%)	82 (1%)	1475 (15%)	552 (6%)	757 (8%)	9824 (100%)

C. Convergence Statistics



Model Convergence Criteria

- C.1 The following tables show the convergence criteria (i.e. Delta, Flow Change Stability and Gap) for the final five loops of the convergence process for all forecast year MATS models.
- C.2 'Delta' is the measure of convergence of the final assignment to ensure that alternative routes used in the assignment process do not differ significantly from the final minimum cost. It is the difference between costs on the various multiple assigned routes and those along the final minimum cost routes, as a percentage of the minimum cost routes. Its value should be less than 1%.
- C.3 Flow Change Stability (P) is the measure of convergence of assignment-simulation loops. It is the percentage of links where assigned flows change by less than 5% between successive assignment simulation loops. Assignment model iterations should continue until at least four successive values of 'P' greater than 90% have been obtained. For the forecast year MATS models, 'P' value of 95% have been used.
- C.4 'Gap' is the measure of convergence between the final SATASS/SATSIM loop. It is the difference between costs on the assigned routes and those along the minimum cost routes, as a percentage of the cost routes. A value of less than 0.25% is recommended.

Table C.1 – Do Minimum Convergence Statistics

Criterion	Loop	2016			2021			2026		
		AM	IP	PM	AM	IP	PM	AM	IP	PM
Number of Loop	n	23	20	25	23	21	30	43	23	41
Gap (%)	n-4	0.0047	0.0020	0.0071	0.0064	0.0033	0.0035	0.029	0.0051	0.049
	n-3	0.0013	0.00046	0.0015	0.0032	0.0016	0.0035	0.025	0.0025	0.030
	n-2	0.00053	0.00007	0.00060	0.0018	0.00020	0.0020	0.021	0.0034	0.019
	n-1	0.00026	0.00004	0.00063	0.0011	0.00027	0.0025	0.017	0.00037	0.018
	n	0.00013	0.00002	0.00037	0.00086	0.00012	0.0012	0.015	0.00019	0.018
Delta (%/Number of Loops)	n-4	0.000/7	0.000/7	0.004/7	0.000/7	0.001/7	0.003/7	0.008/7	0.000/7	0.006/7
	n-3	0.000/7	0.000/7	0.003/7	0.000/7	0.002/7	0.002/7	0.007/7	0.000/7	0.004/7
	n-2	0.000/7	0.000/7	0.001/7	0.000/7	0.000/7	0.002/7	0.005/7	0.000/7	0.000/7
	n-1	0.000/7	0.000/7	0.000/7	0.000/7	0.000/7	0.001/7	0.004/7	0.000/7	0.000/7
	n	0.000/6	0.000/7	0.000/7	0.000/7	0.000/4	0.002/7	0.004/7	0.000/7	0.000/7
Flow Change Stability (%)	n-4	99.9	99.9	99.6	99.8	98.8	96.6	94.9	99.5	95.1
	n-3	95.2	95.5	98.4	99.1	99.7	97.5	95.1	95.4	95.9
	n-2	98.3	99.2	98.5	99.2	100.0	98.5	96.1	97.8	97.2
	n-1	99.4	99.9	99.6	100.0	100.0	98.3	97.6	97.8	97.0
	n	100.0	99.9	99.1	100.0	100.0	99.0	98.5	99.3	96.7

Table C.2 – Do Something Test 1 Convergence Statistics

Criterion	Loop	2016			2021			2026		
		AM	IP	PM	AM	IP	PM	AM	IP	PM
Number of Loop	n	22	21	24	32	25	51	28	217	26
Gap (%)	n-4	0.0016	0.0034	0.0099	0.037	0.017	0.055	0.012	0.023	0.019
	n-3	0.00022	0.0011	0.0010	0.031	0.0091	0.049	0.0094	0.022	0.0094
	n-2	0.00009	0.00049	0.0012	0.028	0.0038	0.043	0.0056	0.021	0.010
	n-1	0.00004	0.00027	0.00020	0.045	0.0016	0.043	0.0030	0.020	0.0047
	n	0.00005	0.00016	0.00090	0.044	0.0036	0.042	0.0064	0.019	0.0064
Delta (%/Number of Loops)	n-4	0.000/7	0.000/7	0.004/7	0.012/7	0.001/7	0.010/7	0.002/7	0.003/7	0.006/7
	n-3	0.000/7	0.000/7	0.003/7	0.000/7	0.002/7	0.010/7	0.004/7	0.003/7	0.004/7
	n-2	0.000/7	0.000/7	0.000/7	0.000/7	0.001/7	0.009/7	0.000/7	0.004/7	0.000/7
	n-1	0.000/7	0.000/7	0.001/7	0.000/7	0.001/7	0.000/7	0.000/7	0.004/7	0.002/7
	n	0.000/7	0.000/7	0.000/7	0.000/7	0.001/7	0.000/7	0.000/7	0.004/7	0.001/7
Flow Change Stability (%)	n-4	99.9	100.0	99.4	95.3	100.0	94.8	95.7	94.8	95.3
	n-3	98.0	94.9	98.1	95.8	96.2	95.8	97.2	95.2	97.6
	n-2	99.7	98.4	98.6	96.0	96.1	96.6	99.9	95.7	98.6
	n-1	99.7	99.9	98.5	96.4	97.3	96.7	100.0	95.9	99.0
	n	99.9	100.0	99.1	94.9	99.0	96.8	99.8	96.2	99.9

Table C.3 – Do Something Test 2 Convergence Statistics

Criterion	Loop	2021			2026		
		AM	IP	PM	AM	IP	PM
Number of Loop	n	34	24	35	37	245	28
Gap (%)	n-4	0.030	0.017	0.049	0.023	0.073	0.067
	n-3	0.054	0.0096	0.045	0.017	0.056	0.073
	n-2	0.051	0.0038	0.044	0.015	0.048	0.054
	n-1	0.050	0.0031	0.050	0.0096	0.045	0.049
	n	0.030	0.0037	0.051	0.0061	0.044	0.048
Delta (%/Number of Loops)	n-4	0.000/7	0.001/7	0.007/7	0.005/7	0.003/7	0.006/7
	n-3	0.000/7	0.001/7	0.000/7	0.001/7	0.002/7	0.004/7
	n-2	0.000/7	0.001/7	0.000/7	0.001/7	0.000/7	0.001/7
	n-1	0.000/7	0.001/7	0.000/7	0.001/7	0.000/7	0.000/7
	n	0.000/7	0.000/7	0.000/7	0.001/7	0.000/7	0.000/7
Flow Change Stability (%)	n-4	95.4	98.7	94.5	96.8	95.0	95.0
	n-3	94.9	99.6	95.8	98.4	95.5	97.6
	n-2	95.4	99.6	95.8	99.5	95.8	99.0
	n-1	96.0	99.5	96.0	99.8	95.8	99.2
	n	96.0	99.8	96.1	99.7	96.0	99.4

D. Model Assignment Summary Statistics

Model Assignment Summary Statistics

D.1 The following tables show the model summary statistics, including total travel time, total distance, network average speed, for all forecast years, time periods and modelled scenarios.

Table D.1 – Model Summary Statistics (2016)

Scenario	2010 Base	2016 DM	2016 DS1	2016 DS2
AM				
Total Travel Time (pcu-hr)	3,310	3,738	3,732	-
<i>% diff (compared to 2010 Base)</i>		12.9%	12.7%	-
<i>% diff (compared to 2016 DM)</i>			-0.2%	-
Total Distance (pcu-km)	207,777	234,826	234,604	-
<i>% diff (compared to 2010 Base)</i>		13.0%	12.9%	-
<i>% diff (compared to 2016 DM)</i>			-0.1%	-
Average Speed (kph)	62.8	62.8	62.9	-
<i>% diff (compared to 2010 Base)</i>		0.0%	0.2%	-
<i>% diff (compared to 2016 DM)</i>			0.2%	-
Total Trips Loaded (pcu)	6,420	7,410	7,415	-
<i>% diff (compared to 2010 Base)</i>		15.4%	15.5%	-
<i>% diff (compared to 2016 DM)</i>			0.1%	-
IP				
Total Travel Time (pcu-hr)	2,346	2,662	2,658	-
<i>% diff (compared to 2010 Base)</i>		13.5%	13.3%	-
<i>% diff (compared to 2016 DM)</i>			-0.1%	-
Total Distance (pcu-km)	148,355	167,402	167,355	-
<i>% diff (compared to 2010 Base)</i>		12.8%	12.8%	-
<i>% diff (compared to 2016 DM)</i>			0.0%	-
Average Speed (kph)	63.3	62.9	63.0	-
<i>% diff (compared to 2010 Base)</i>		-0.6%	-0.5%	-
<i>% diff (compared to 2016 DM)</i>			0.2%	-
Total Trips Loaded (pcu)	5,306	6,131	6,136	-
<i>% diff (compared to 2010 Base)</i>		15.6%	15.6%	-
<i>% diff (compared to 2016 DM)</i>			0.1%	-
PM				
Total Travel Time (pcu-hr)	3,757	4,281	4,274	-
<i>% diff (compared to 2010 Base)</i>		14.0%	13.8%	-
<i>% diff (compared to 2016 DM)</i>			-0.2%	-
Total Distance (pcu-km)	228,244	257,156	256,811	-
<i>% diff (compared to 2010 Base)</i>		12.7%	12.5%	-
<i>% diff (compared to 2016 DM)</i>			-0.1%	-
Average Speed (kph)	60.8	60.1	60.1	-
<i>% diff (compared to 2010 Base)</i>		-1.2%	-1.2%	-
<i>% diff (compared to 2016 DM)</i>			0.0%	-
Total Trips Loaded (pcu)	6,913	7,973	7,975	-
<i>% diff (compared to 2010 Base)</i>		15.3%	15.4%	-
<i>% diff (compared to 2016 DM)</i>			0.0%	-

Table D.2 – Model Summary Statistics (2021)

Scenario	2010 Base	2021 DM	2021 DS1	2021 DS2
AM				
Total Travel Time (pcu-hr)	3,310	4,072	4,098	4,090
<i>% diff (compared to 2010 Base)</i>		23.0%	23.8%	23.5%
<i>% diff (compared to 2021 DM)</i>			0.6%	0.4%
Total Distance (pcu-km)	207,777	252,397	252,229	252,314
<i>% diff (compared to 2010 Base)</i>		21.5%	21.4%	21.4%
<i>% diff (compared to 2021 DM)</i>			-0.1%	0.0%
Average Speed (kph)	62.8	62.0	61.5	61.7
<i>% diff (compared to 2010 Base)</i>		-1.3%	-2.1%	-1.8%
<i>% diff (compared to 2021 DM)</i>			-0.8%	-0.5%
Total Trips Loaded (pcu)	6,420	7,990	7,988	8,015
<i>% diff (compared to 2010 Base)</i>		24.5%	24.4%	24.8%
<i>% diff (compared to 2021 DM)</i>			0.0%	0.3%
IP				
Total Travel Time (pcu-hr)	2,346	2,904	2,904	2,906
<i>% diff (compared to 2010 Base)</i>		23.8%	23.8%	23.9%
<i>% diff (compared to 2021 DM)</i>			0.0%	0.1%
Total Distance (pcu-km)	148,355	180,897	180,820	180,885
<i>% diff (compared to 2010 Base)</i>		21.9%	21.9%	21.9%
<i>% diff (compared to 2021 DM)</i>			0.0%	0.0%
Average Speed (kph)	63.3	62.3	62.3	62.2
<i>% diff (compared to 2010 Base)</i>		-1.6%	-1.6%	-1.7%
<i>% diff (compared to 2021 DM)</i>			0.0%	-0.2%
Total Trips Loaded (pcu)	5,306	6,691	6,696	6,716
<i>% diff (compared to 2010 Base)</i>		26.1%	26.2%	26.6%
<i>% diff (compared to 2021 DM)</i>			0.1%	0.4%
PM				
Total Travel Time (pcu-hr)	3,757	4,734	4,745	4,752
<i>% diff (compared to 2010 Base)</i>		26.0%	26.3%	26.5%
<i>% diff (compared to 2021 DM)</i>			0.2%	0.4%
Total Distance (pcu-km)	228,244	277,142	277,028	277,400
<i>% diff (compared to 2010 Base)</i>		21.4%	21.4%	21.5%
<i>% diff (compared to 2021 DM)</i>			0.0%	0.1%
Average Speed (kph)	60.8	58.5	58.4	58.4
<i>% diff (compared to 2010 Base)</i>		-3.8%	-3.9%	-3.9%
<i>% diff (compared to 2021 DM)</i>			-0.2%	-0.2%
Total Trips Loaded (pcu)	6,913	8,650	8,654	8,681
<i>% diff (compared to 2010 Base)</i>		25.1%	25.2%	25.6%
<i>% diff (compared to 2021 DM)</i>			0.0%	0.4%

Table D.3 – Model Summary Statistics (2026)

Scenario	2010 Base	2026 DM	2026 DS1	2026 DS2
AM				
Total Travel Time (pcu-hr)	3,310	4,436	4,507	4,582
<i>% diff (compared to 2010 Base)</i>		34.0%	36.1%	38.4%
<i>% diff (compared to 2026 DM)</i>			1.6%	3.3%
Total Distance (pcu-km)	207,777	270,469	270,567	272,104
<i>% diff (compared to 2010 Base)</i>		30.2%	30.2%	31.0%
<i>% diff (compared to 2026 DM)</i>			0.0%	0.6%
Average Speed (kph)	62.8	61.0	60.0	59.4
<i>% diff (compared to 2010 Base)</i>		-2.9%	-4.5%	-5.4%
<i>% diff (compared to 2026 DM)</i>			-1.6%	-2.6%
Total Trips Loaded (pcu)	6,420	8,619	8,618	9,040
<i>% diff (compared to 2010 Base)</i>		34.2%	34.2%	40.8%
<i>% diff (compared to 2026 DM)</i>			0.0%	4.9%
IP				
Total Travel Time (pcu-hr)	2,346	3,186	3,199	3,251
<i>% diff (compared to 2010 Base)</i>		35.8%	36.4%	38.6%
<i>% diff (compared to 2026 DM)</i>			0.4%	2.1%
Total Distance (pcu-km)	148,355	195,300	195,341	196,733
<i>% diff (compared to 2010 Base)</i>		31.6%	31.7%	32.6%
<i>% diff (compared to 2026 DM)</i>			0.0%	0.7%
Average Speed (kph)	63.3	61.3	61.1	60.5
<i>% diff (compared to 2010 Base)</i>		-3.2%	-3.5%	-4.4%
<i>% diff (compared to 2026 DM)</i>			-0.3%	-1.3%
Total Trips Loaded (pcu)	5,306	7,317	7,321	7,632
<i>% diff (compared to 2010 Base)</i>		37.9%	38.0%	43.8%
<i>% diff (compared to 2026 DM)</i>			0.1%	4.3%
PM				
Total Travel Time (pcu-hr)	3,757	5,234	5,275	5,421
<i>% diff (compared to 2010 Base)</i>		39.3%	40.4%	44.3%
<i>% diff (compared to 2026 DM)</i>			0.8%	3.6%
Total Distance (pcu-km)	228,244	298,359	298,507	304,584
<i>% diff (compared to 2010 Base)</i>		30.7%	30.8%	33.4%
<i>% diff (compared to 2026 DM)</i>			0.0%	2.1%
Average Speed (kph)	60.8	57.0	56.6	56.2
<i>% diff (compared to 2010 Base)</i>		-6.3%	-6.9%	-7.6%
<i>% diff (compared to 2026 DM)</i>			-0.7%	-1.4%
Total Trips Loaded (pcu)	6,913	9,400	9,403	9,824
<i>% diff (compared to 2010 Base)</i>		36.0%	36.0%	42.1%
<i>% diff (compared to 2026 DM)</i>			0.0%	4.5%

E. Link Data for Key Corridors

Link Data for Key Corridors

E.1 The figures below show the traffic flow data, including V/C and delay, for key corridors within the March network for all forecast year models. For the V/C plots, all V/C values that are greater than 85% are highlighted in pink.

Figure E.1 – Flow Data (pcu) (Do Minimum)

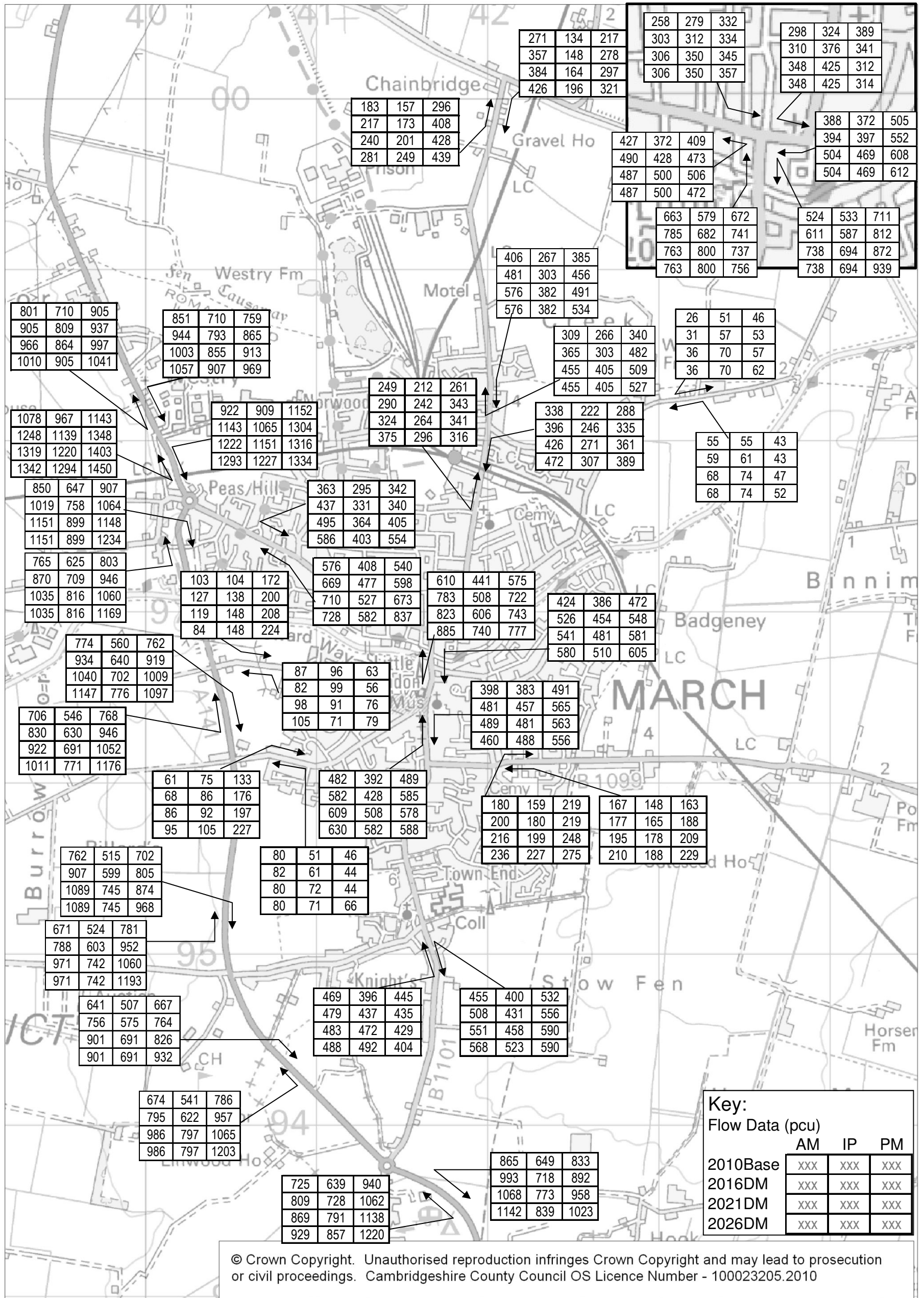

Figure E.2 – Flow Data (pcu) (Do Something Test 1)

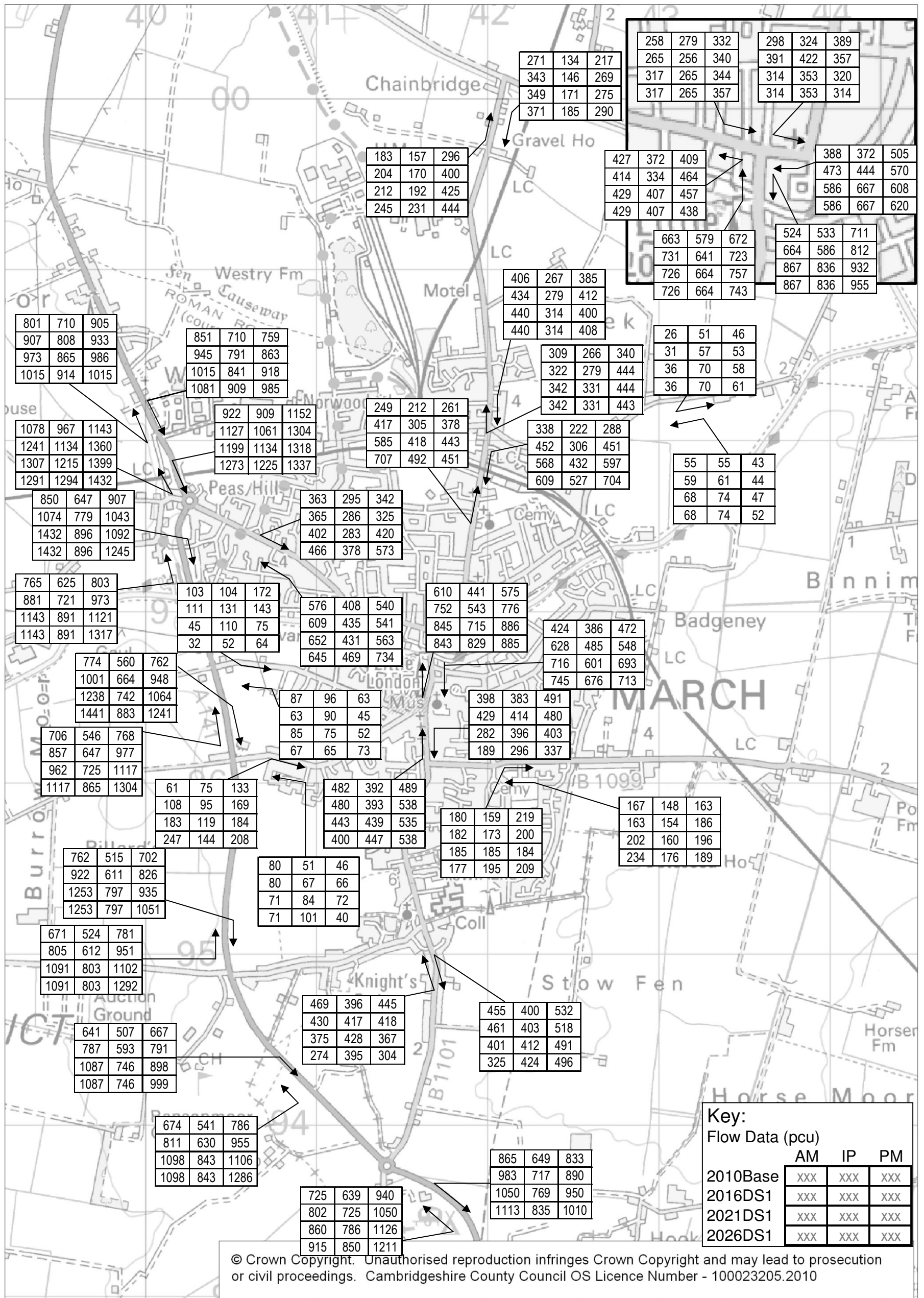

Figure E.3 – Flow Data (pcu) (Do Something Test 2)

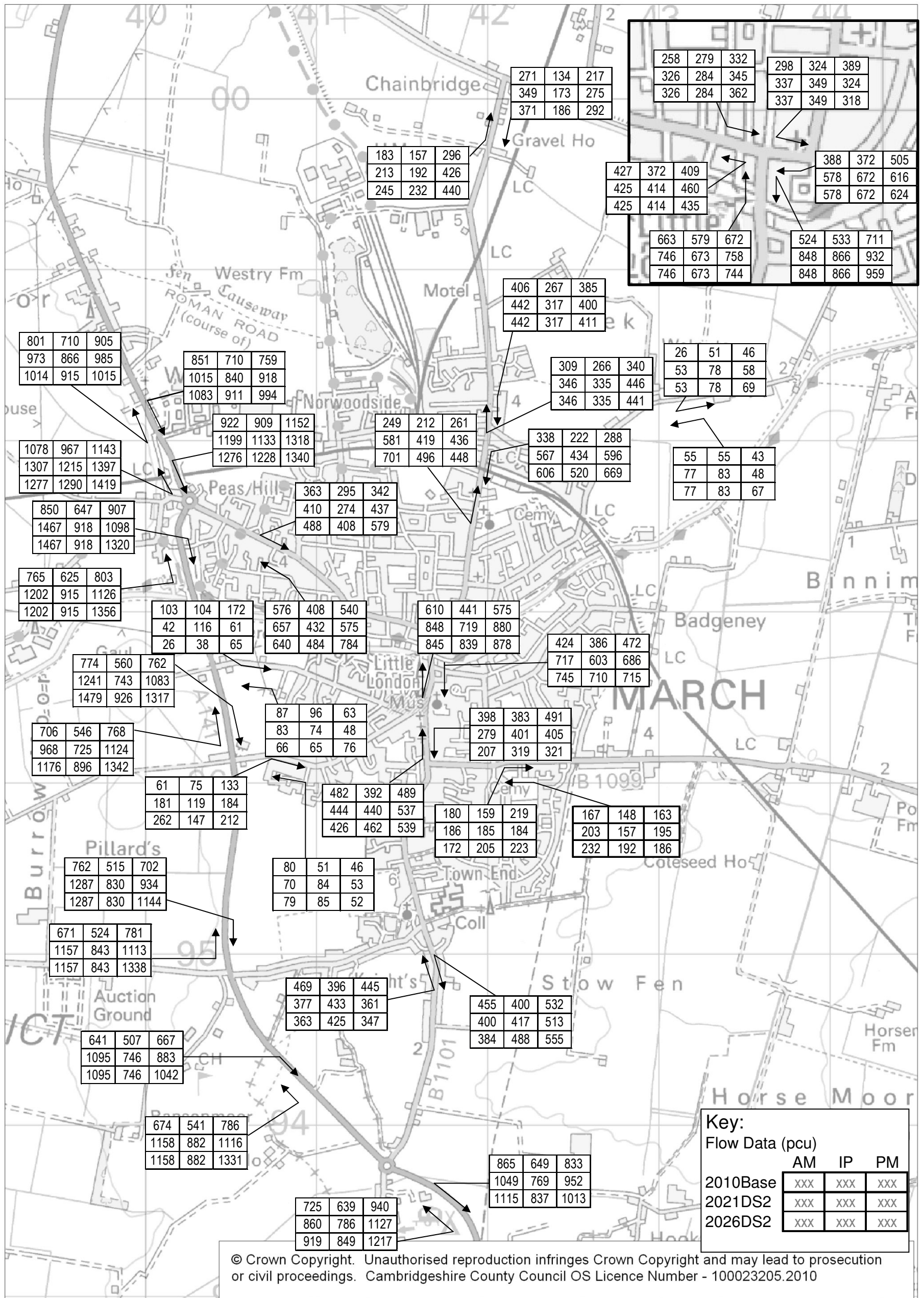
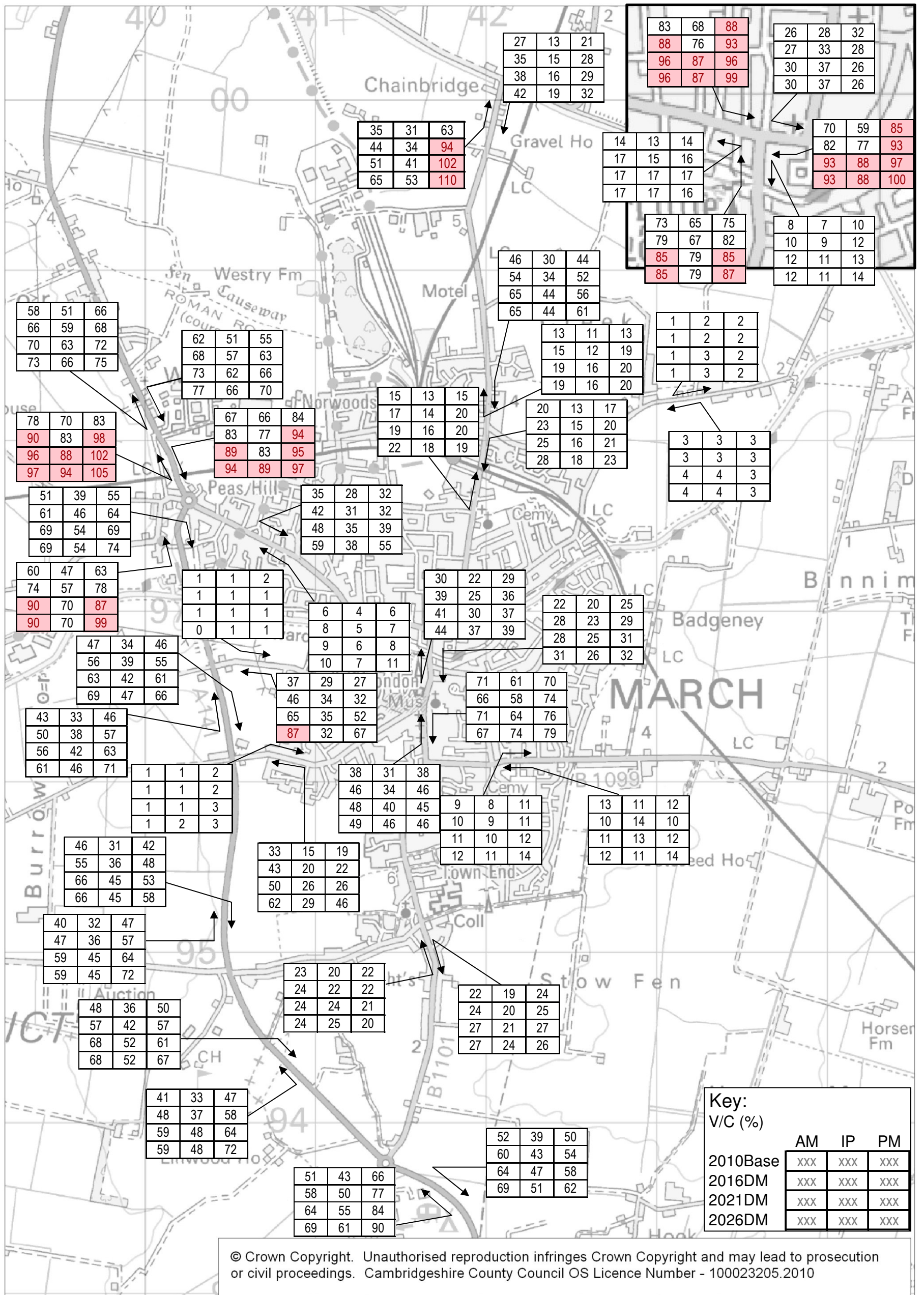

Figure E.4 – V/C Data (%) (Do Minimum)



Key:
V/C (%)

	AM	IP	PM
2010Base	XXX	XXX	XXX
2016DM	XXX	XXX	XXX
2021DM	XXX	XXX	XXX
2026DM	XXX	XXX	XXX

© Crown Copyright. Unauthorised reproduction infringes Crown Copyright and may lead to prosecution or civil proceedings. Cambridgeshire County Council OS Licence Number - 100023205.2010

Figure E.5- V/C Data (%) (Do Something Test 1)

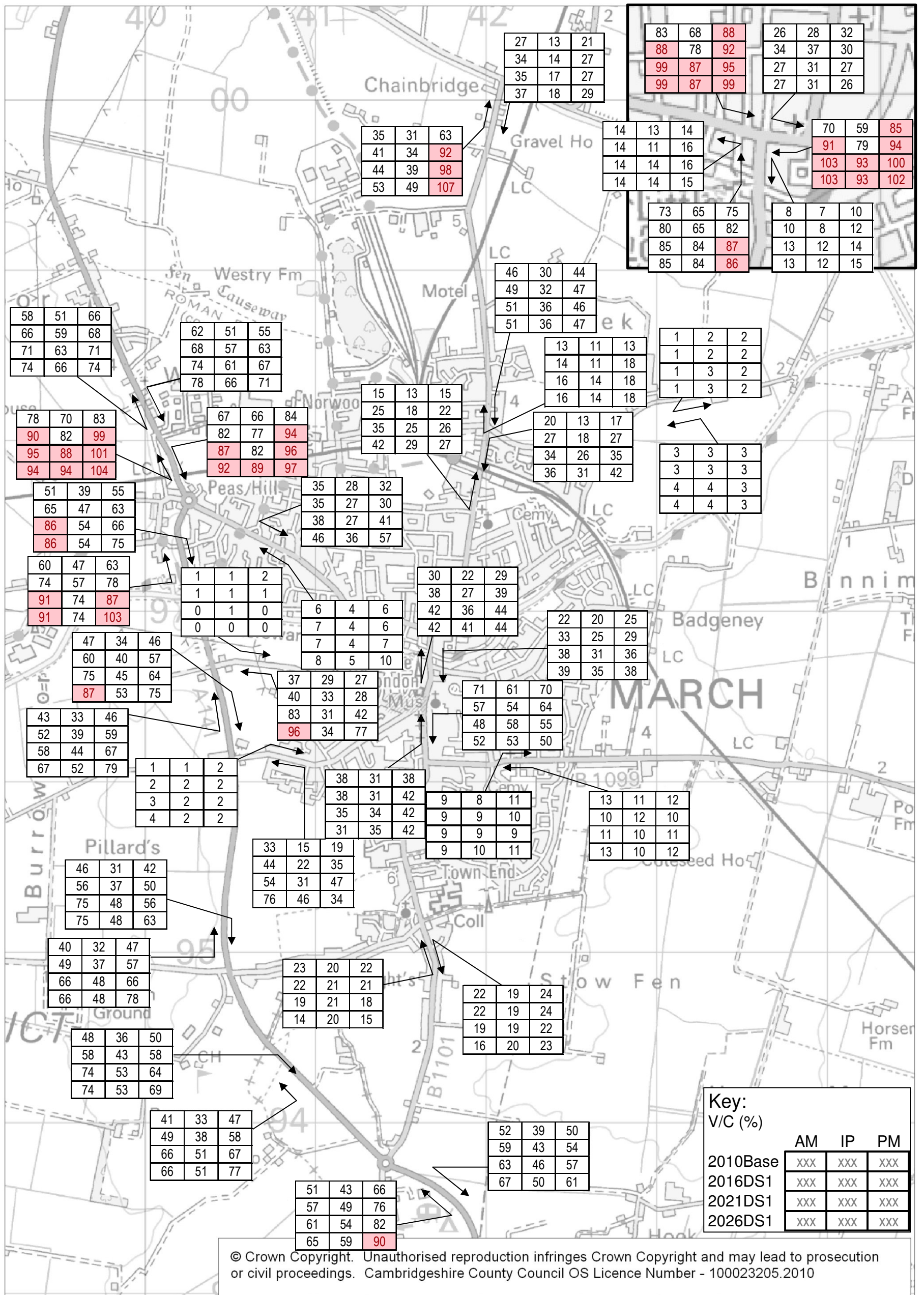

Figure E.6- V/C Data (%) (Do Something Test 2)

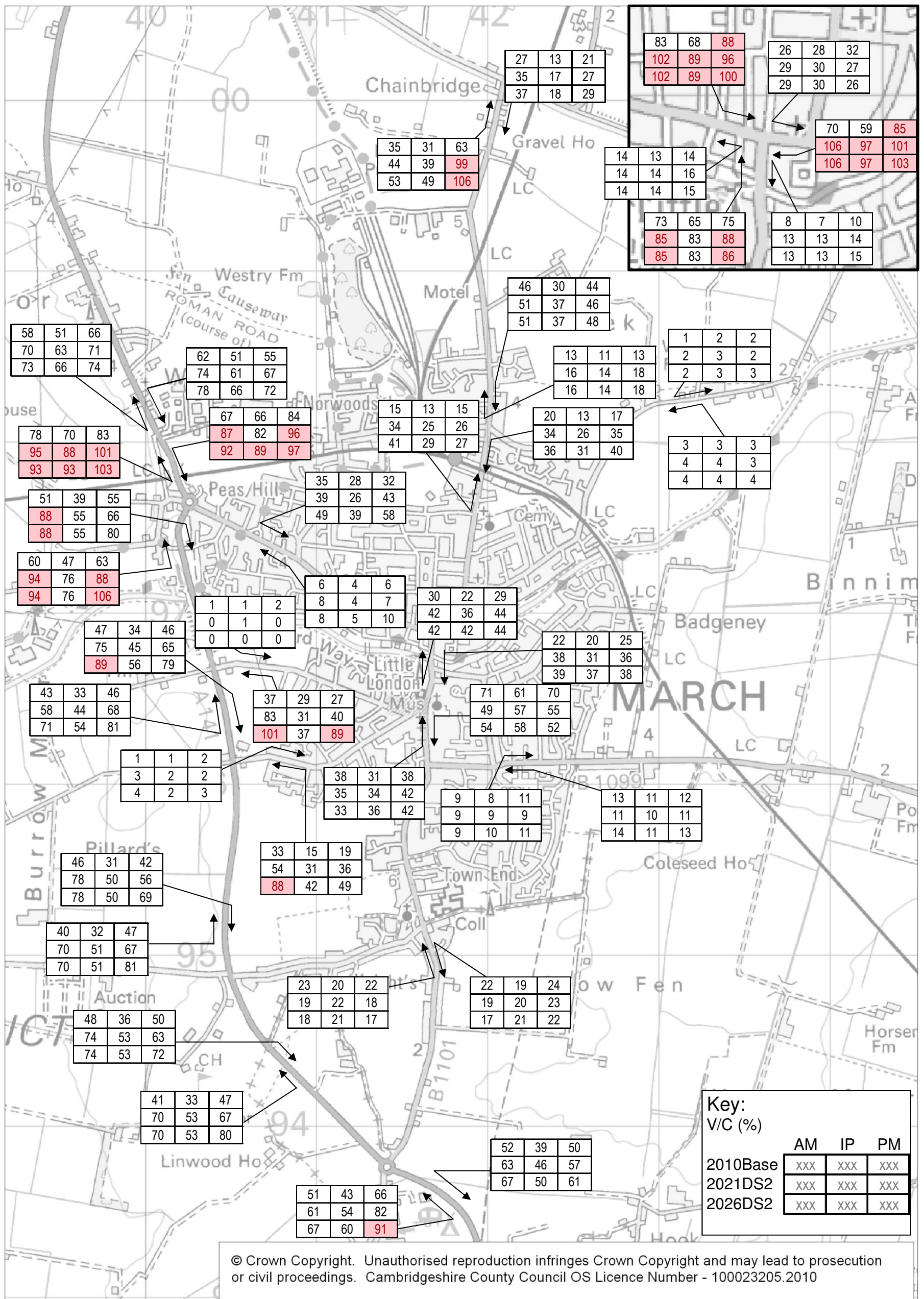

Figure E.7– Delay Data (per veh in seconds) (Do Minimum)

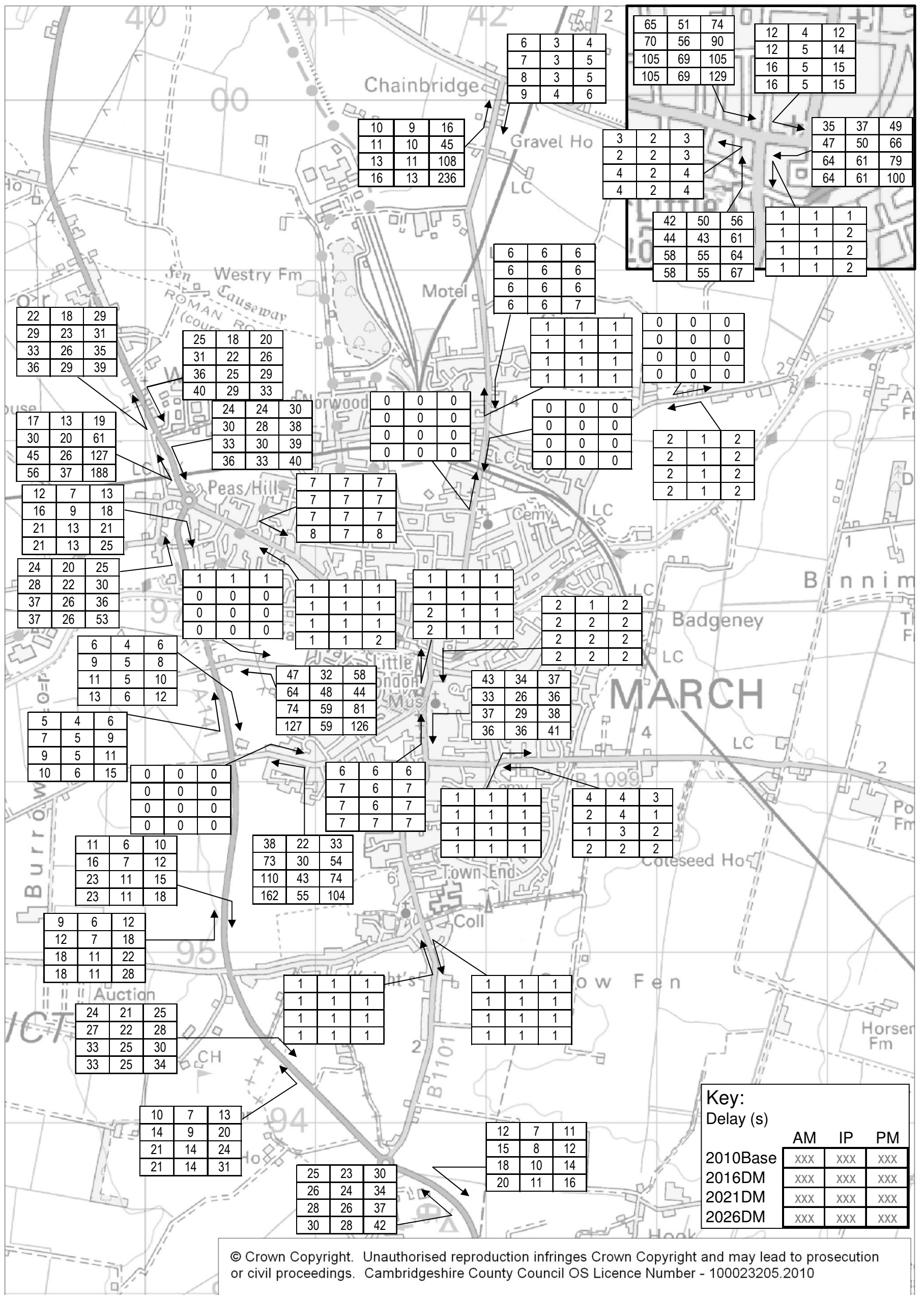

Figure E.8– Delay Data (per veh in seconds) (Do Something Test 1)

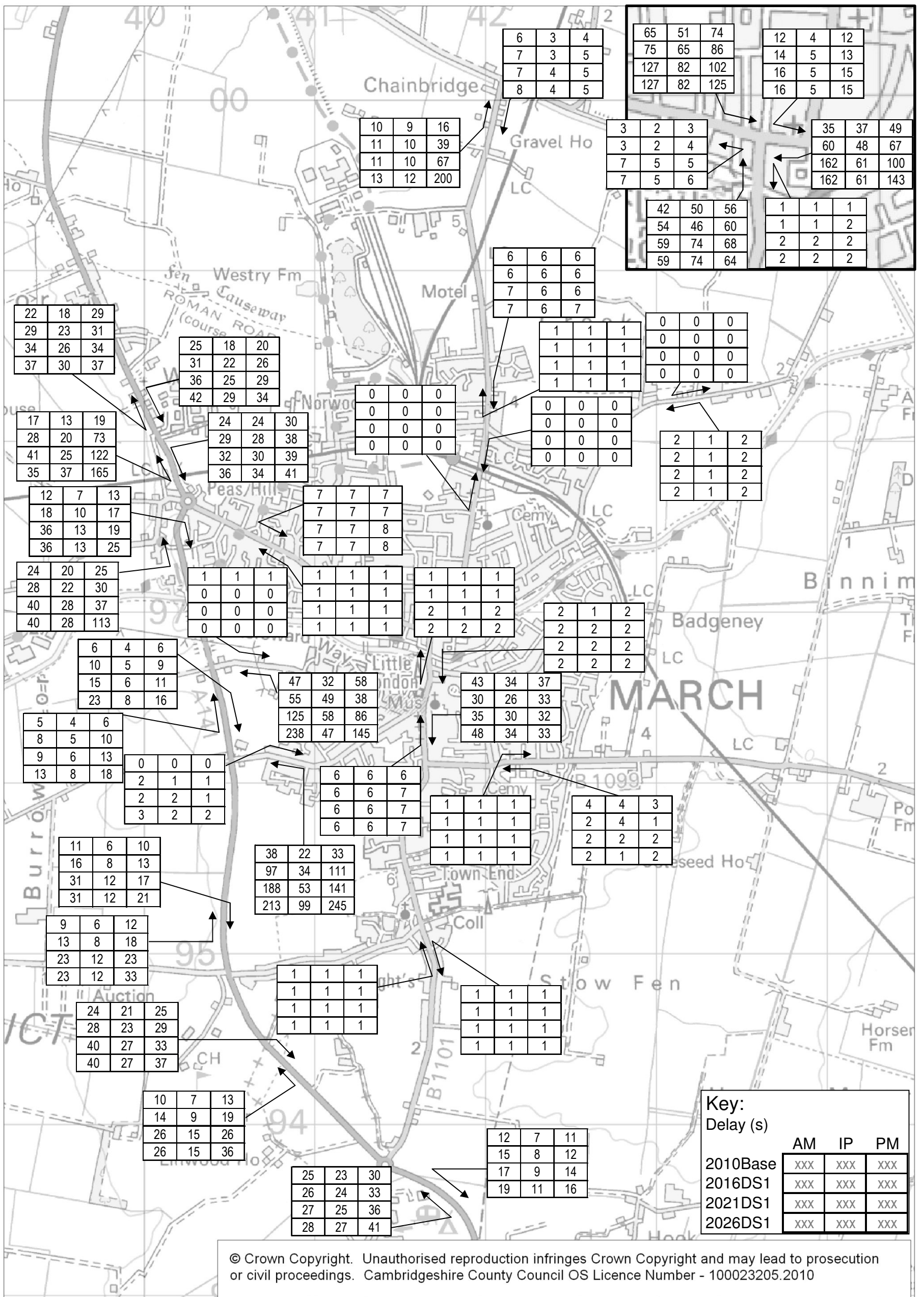
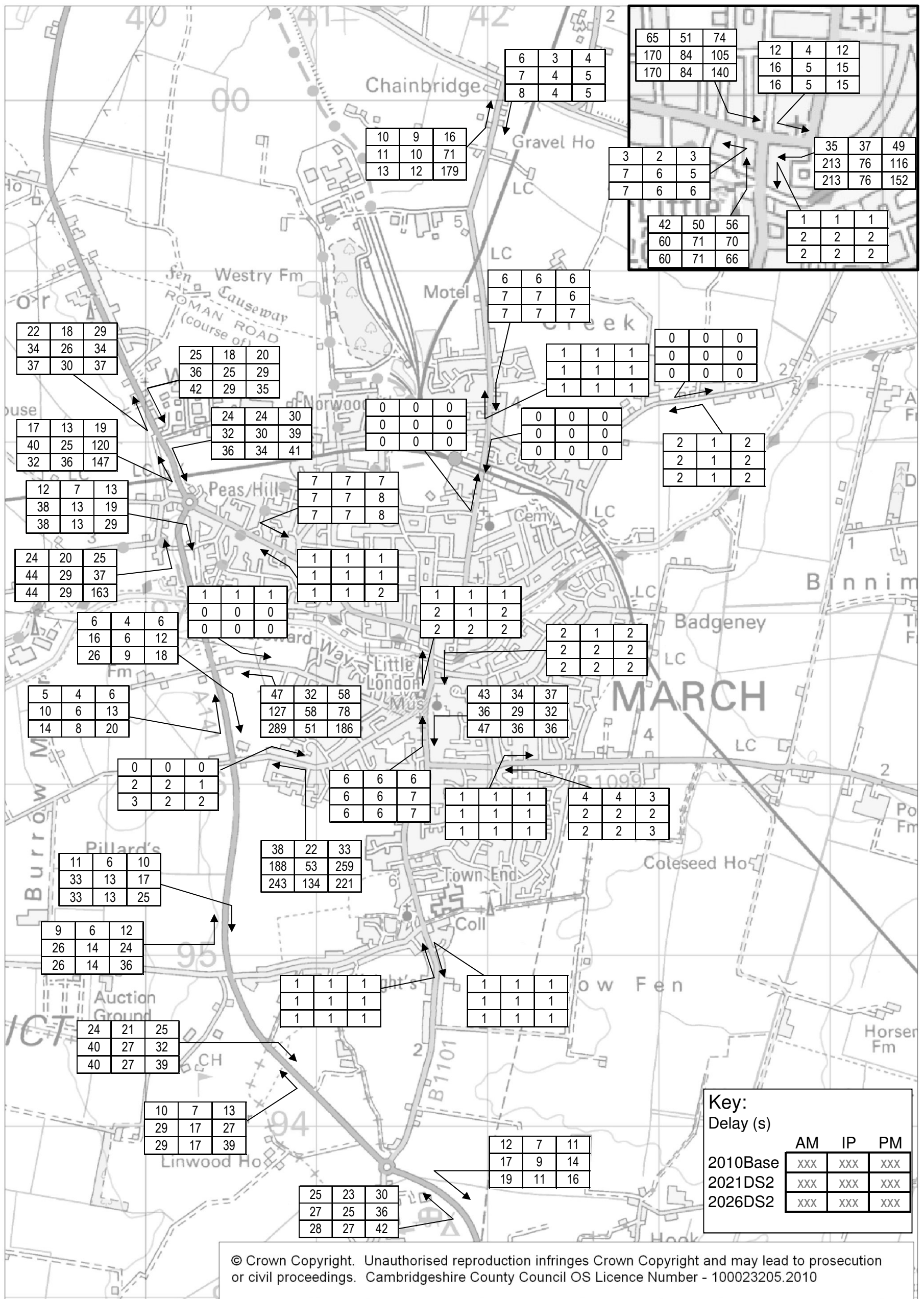

Figure E.9– Delay Data (per veh in seconds) (Do Something Test 2)



F. Traffic Flow Difference Plots

Figure F.2 – Flow Difference (2016 DM vs 2010 Base, IP)

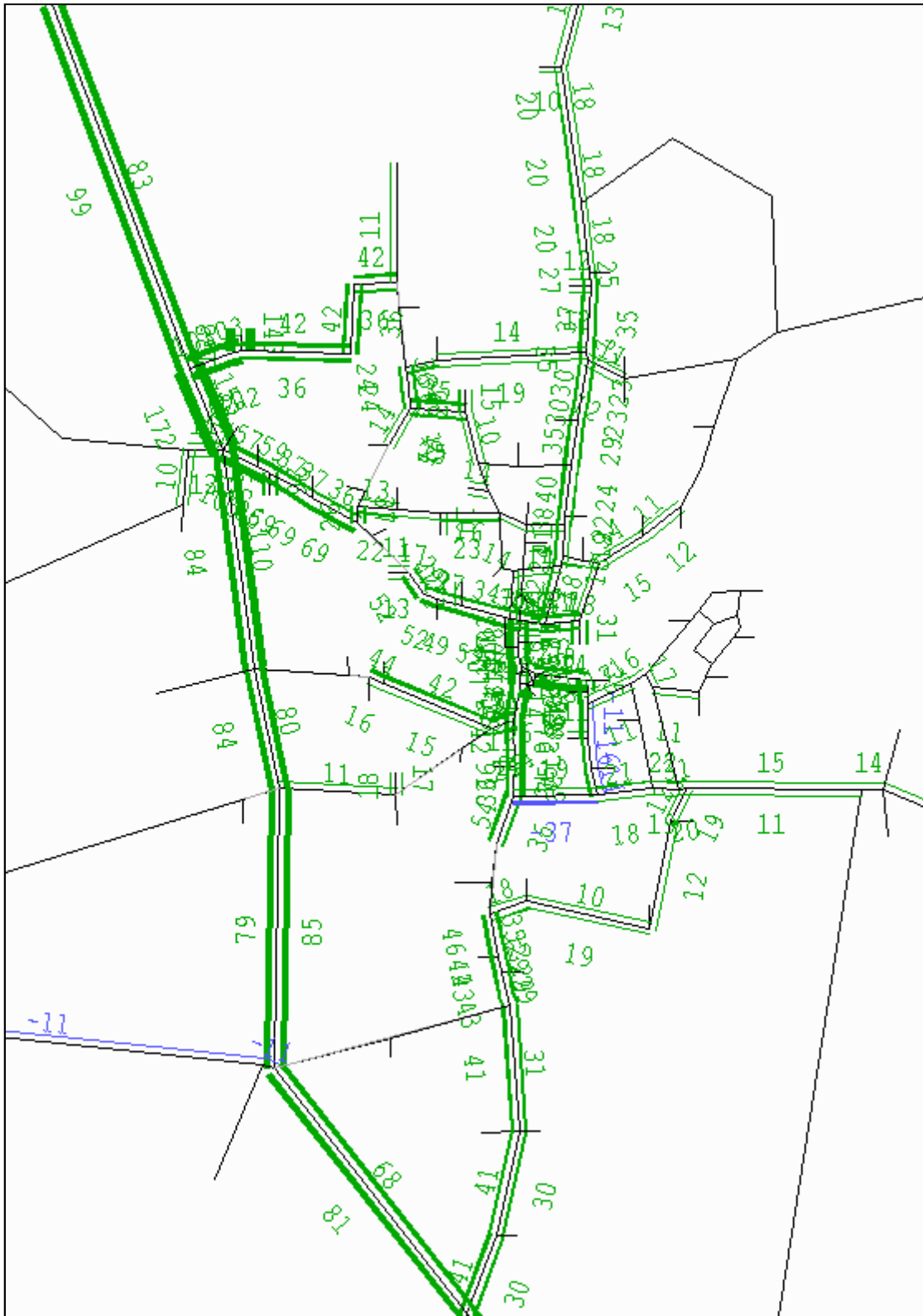

Figure F.3 – Flow Difference (2016 DM vs 2010 Base, PM)

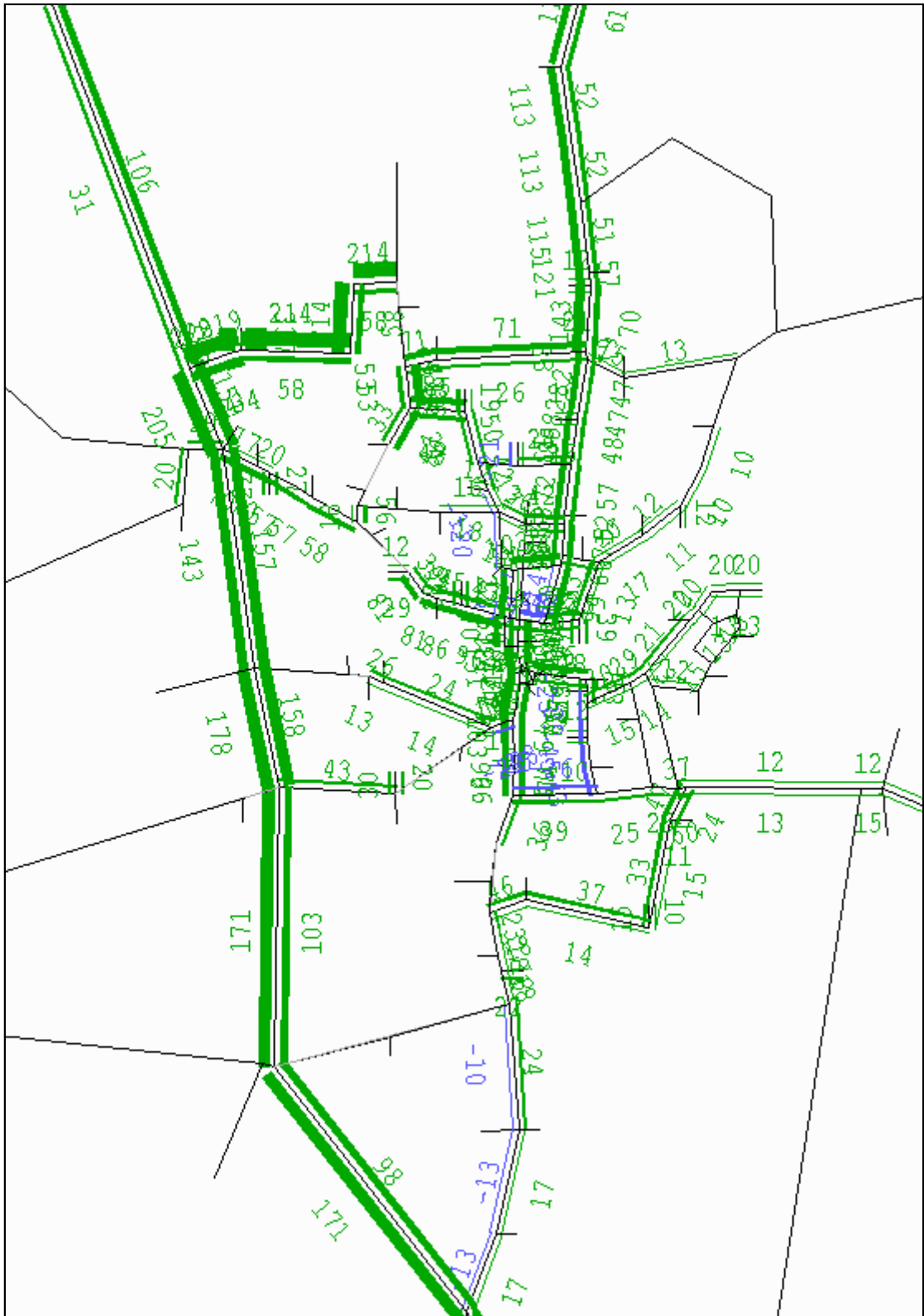

Figure F.4 – Flow Difference (2016 DS1 vs 2016 DM, AM)

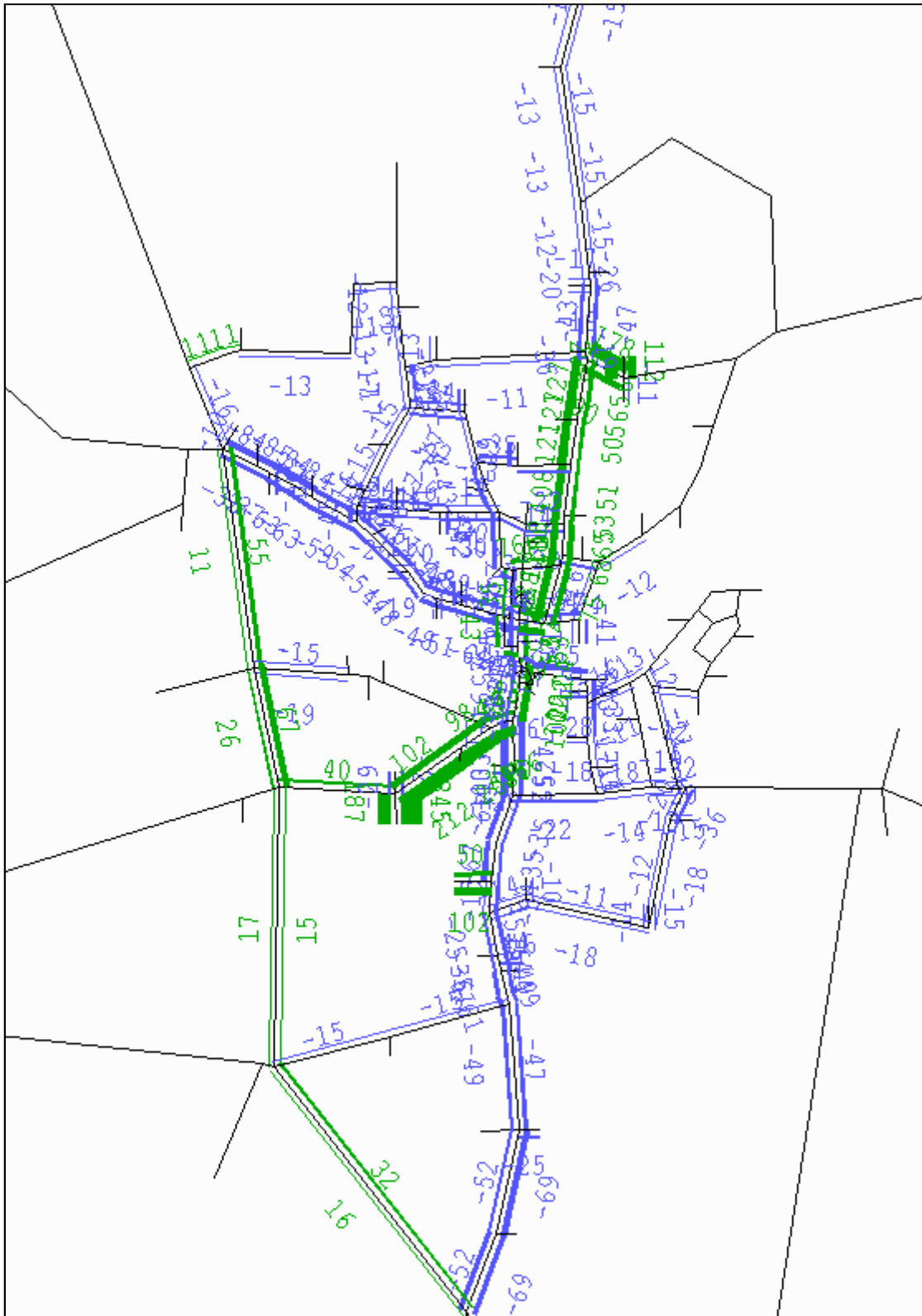

Figure F.5 – Flow Difference (2016 DS1 vs 2016 DM, IP)

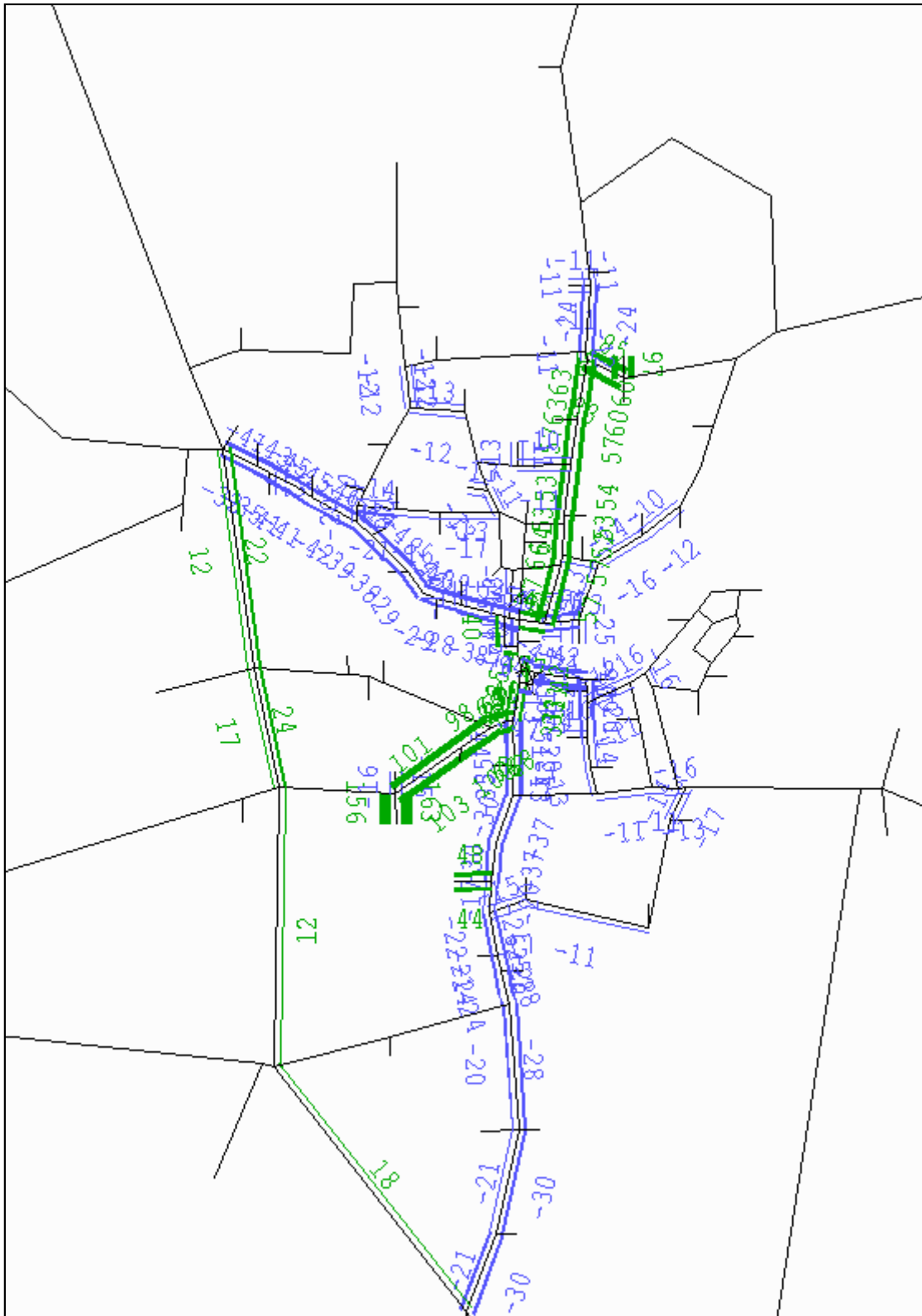

Figure F.7 – Flow Difference (2021 DM vs 2010 Base, AM)

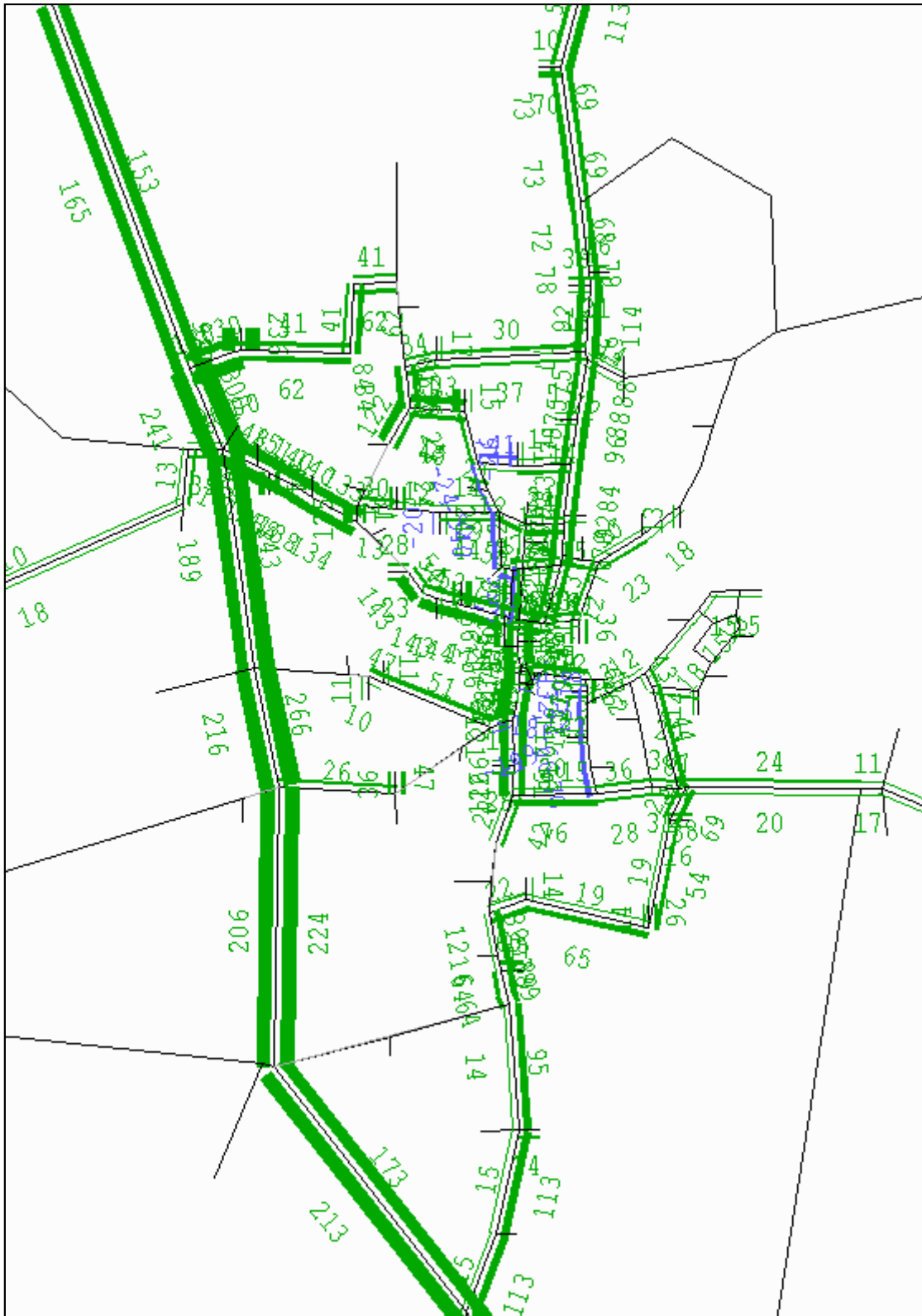

Figure F.9 – Flow Difference (2021 DM vs 2010 Base, PM)

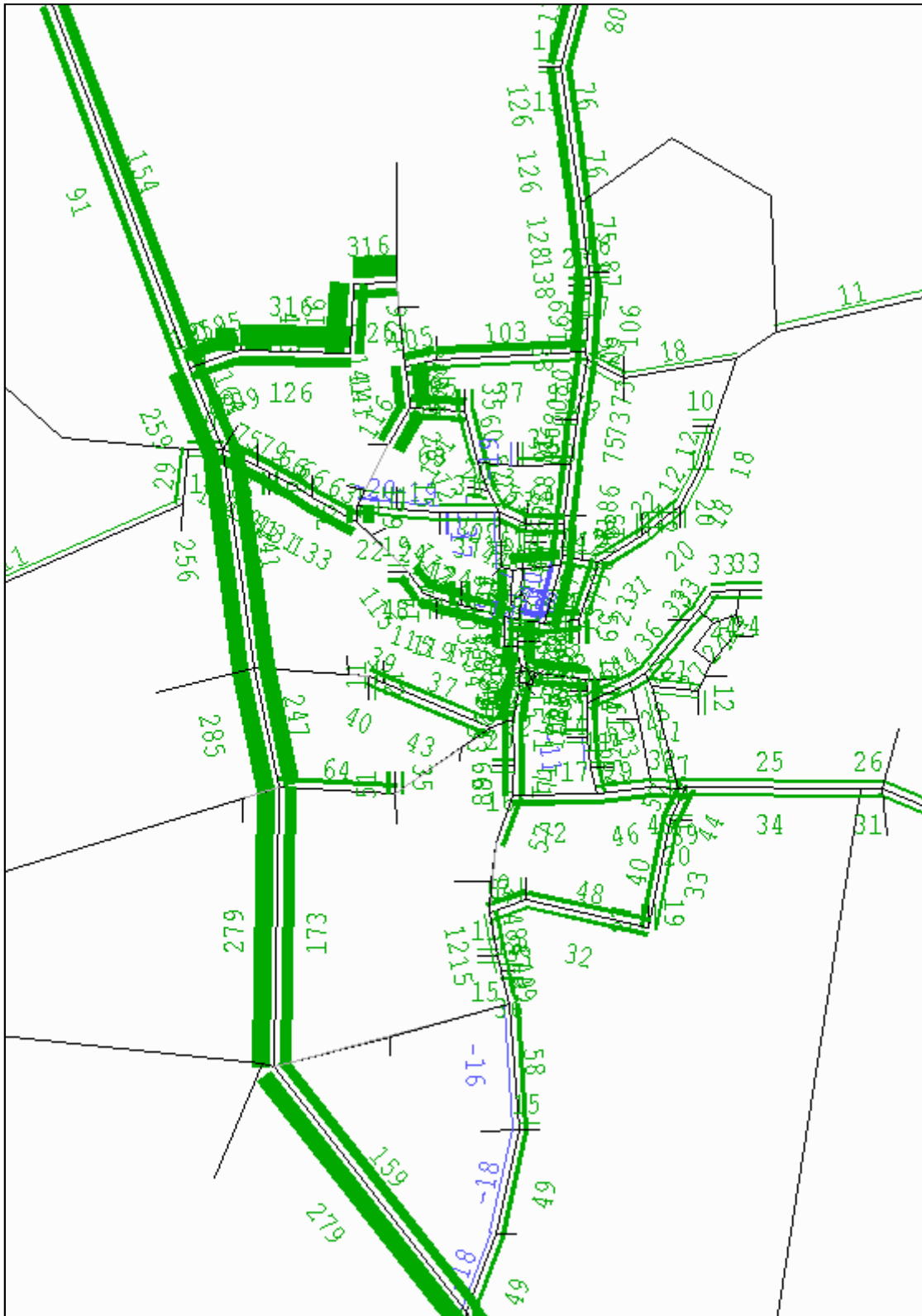

Figure F.11 – Flow Difference (2021 DS1 vs 2021 DM, IP)

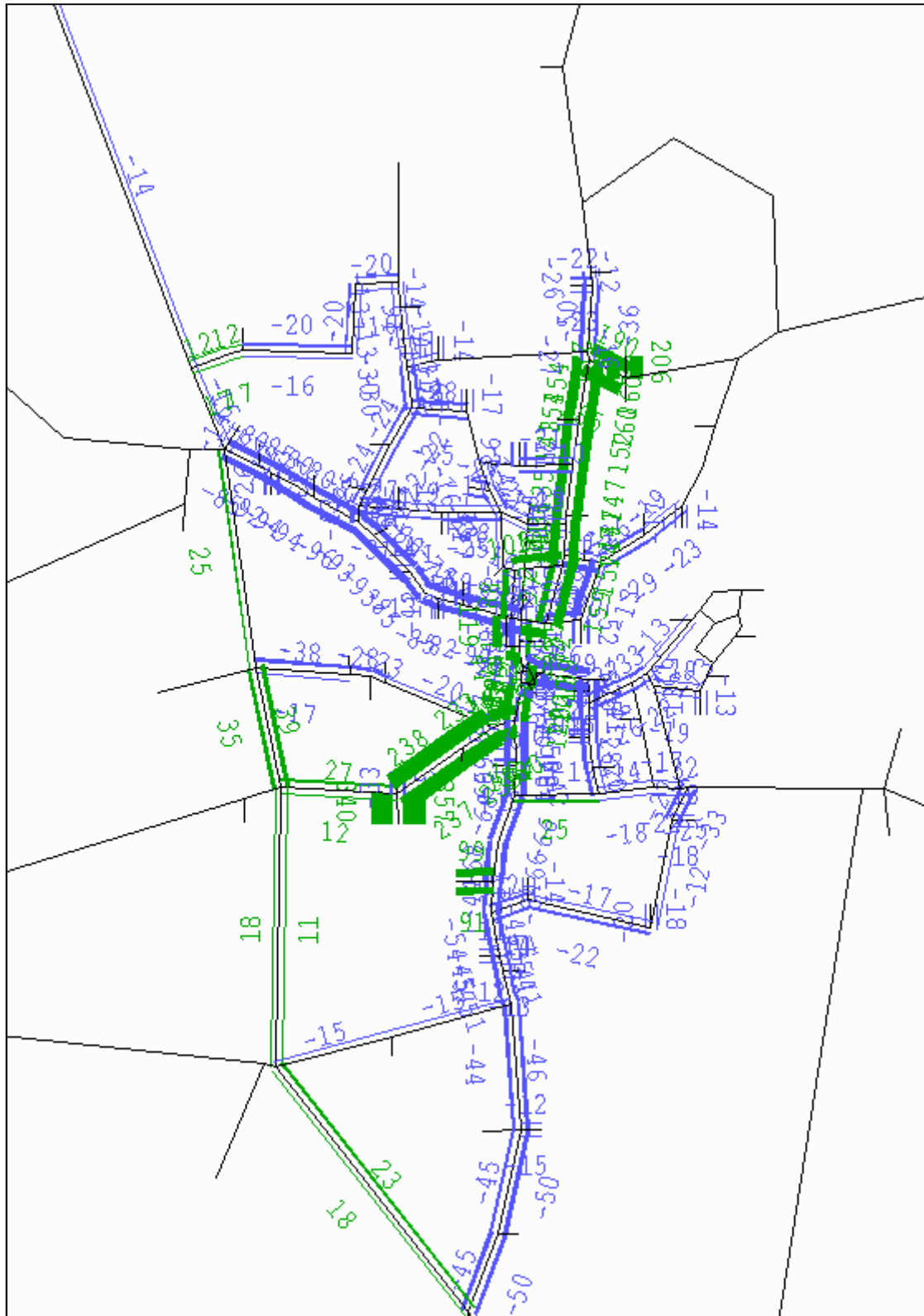

Figure F.12 – Flow Difference (2021 DS1 vs 2021 DM, PM)

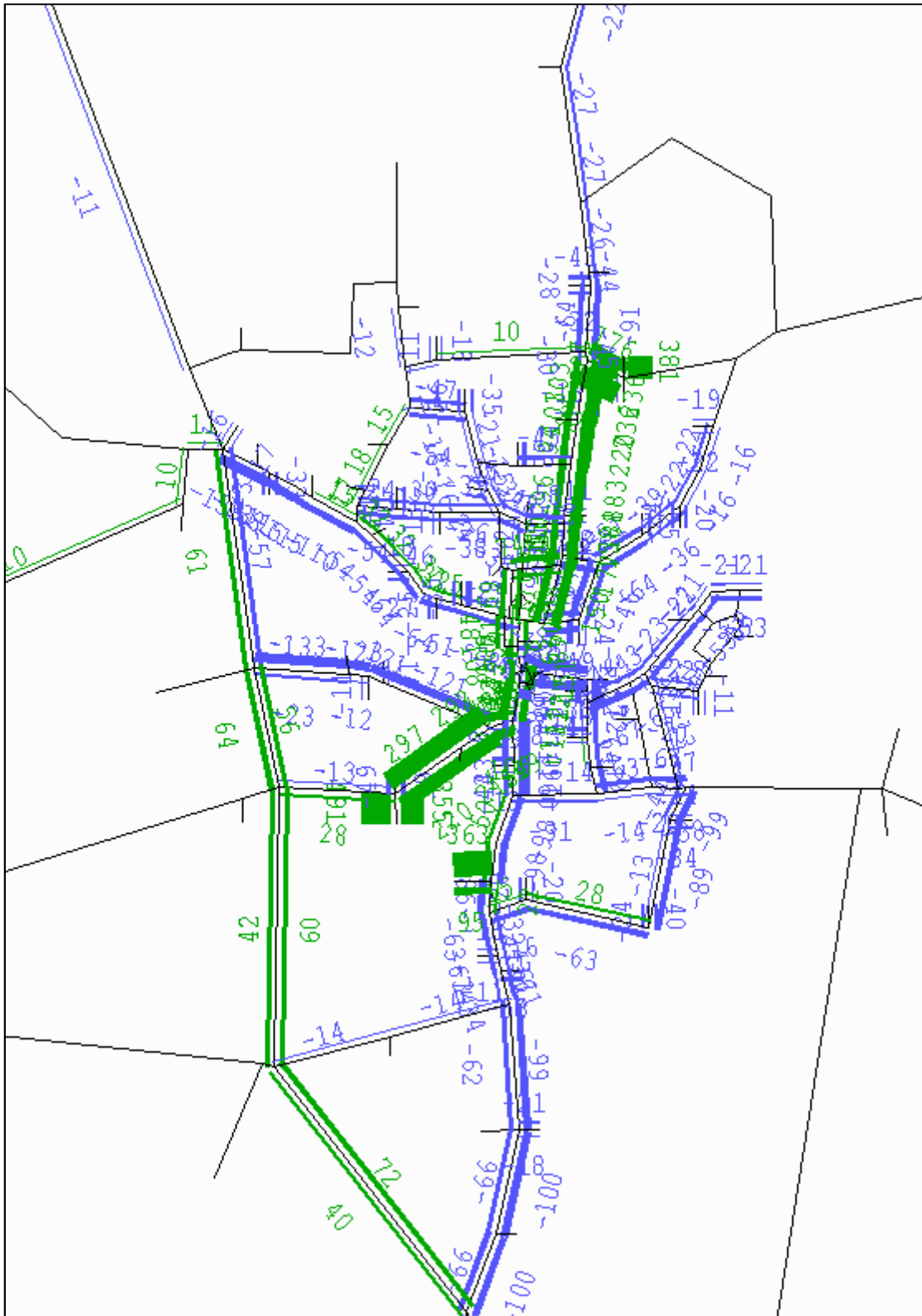

Figure F.13 – Flow Difference (2021 DS2 vs 2021 DS1, AM)

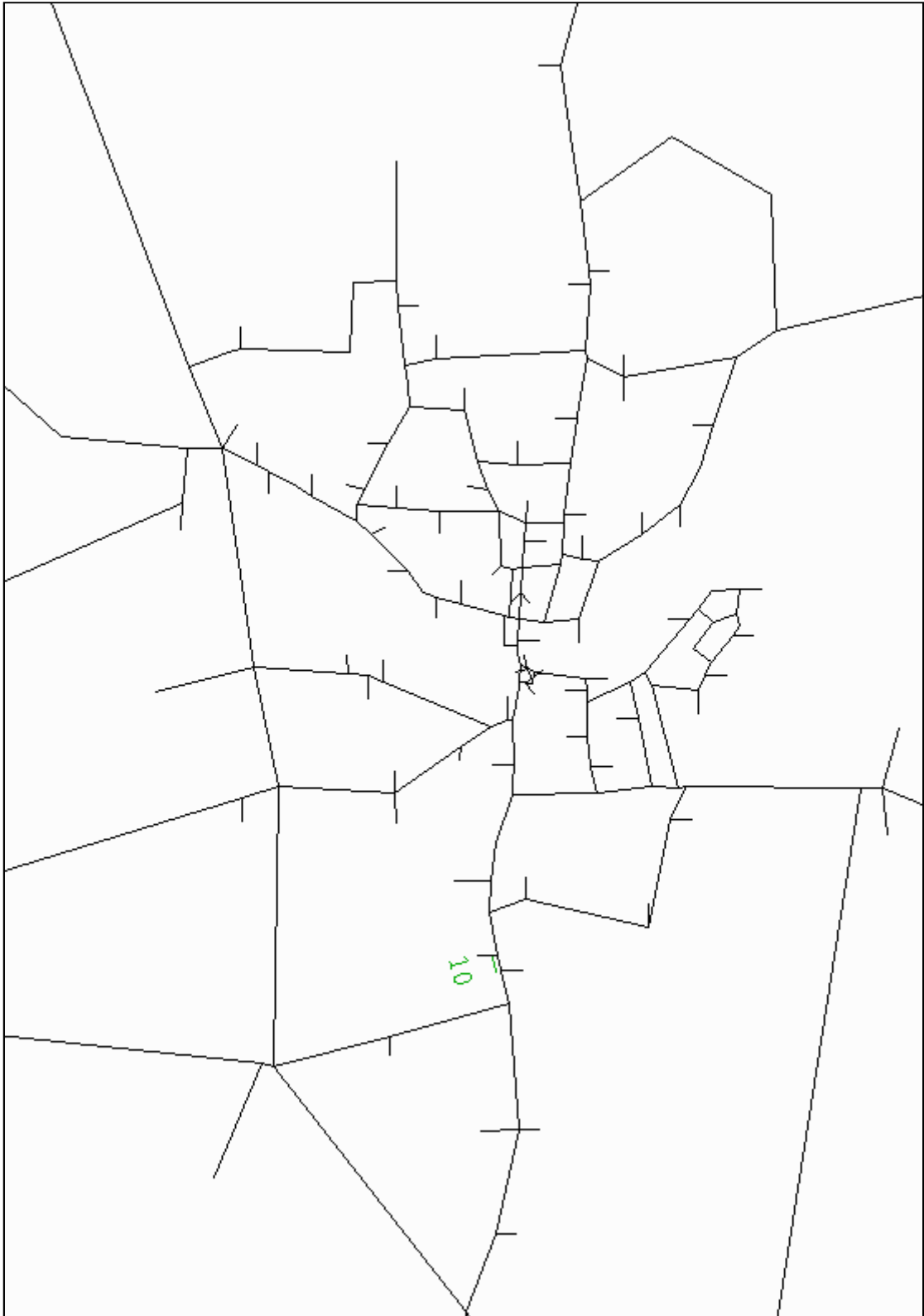

Figure F.14 – Flow Difference (2021 DS2 vs 2021 DS1, IP)

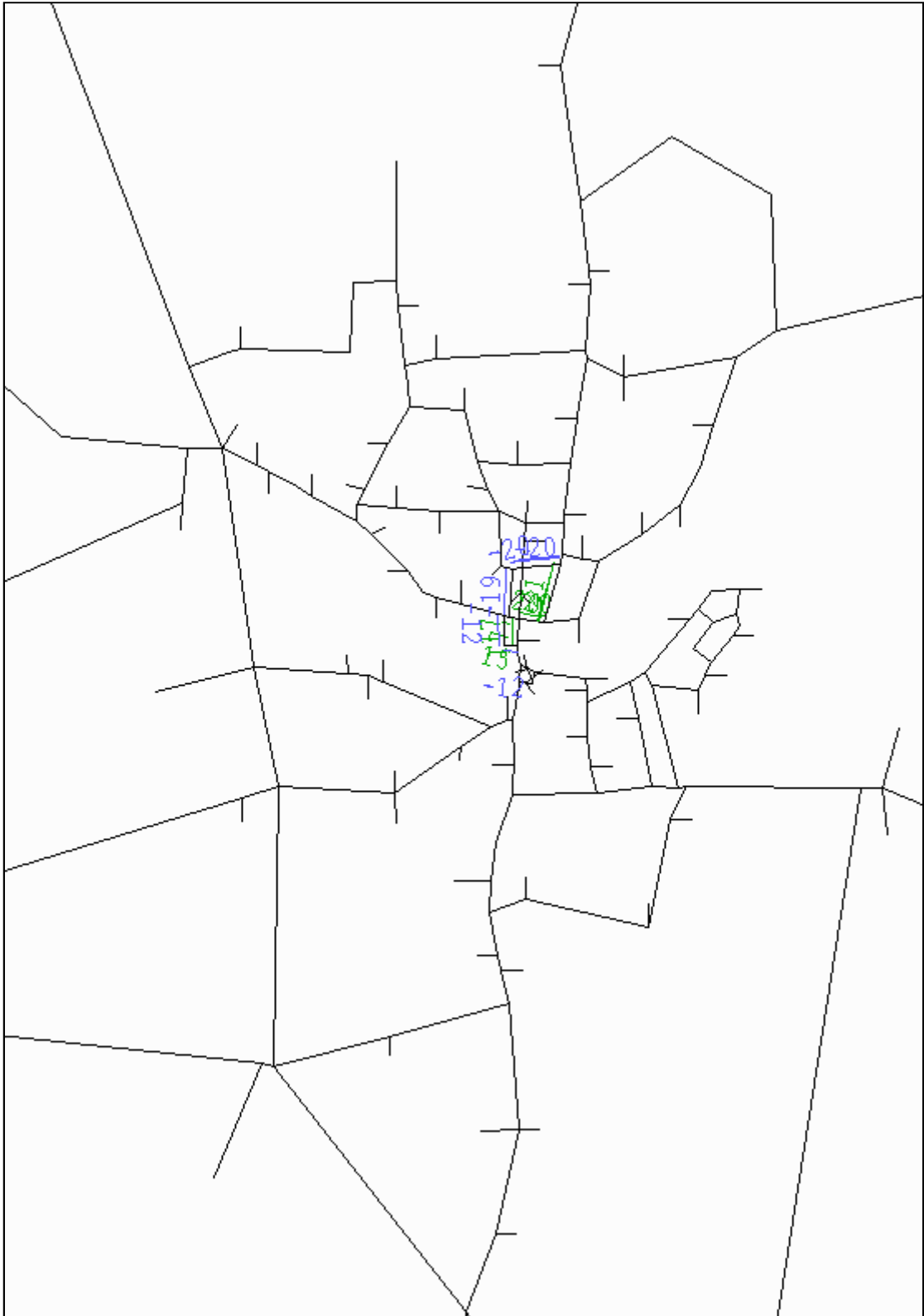

Figure F.15 – Flow Difference (2021 DS2 vs 2021 DS1, PM)

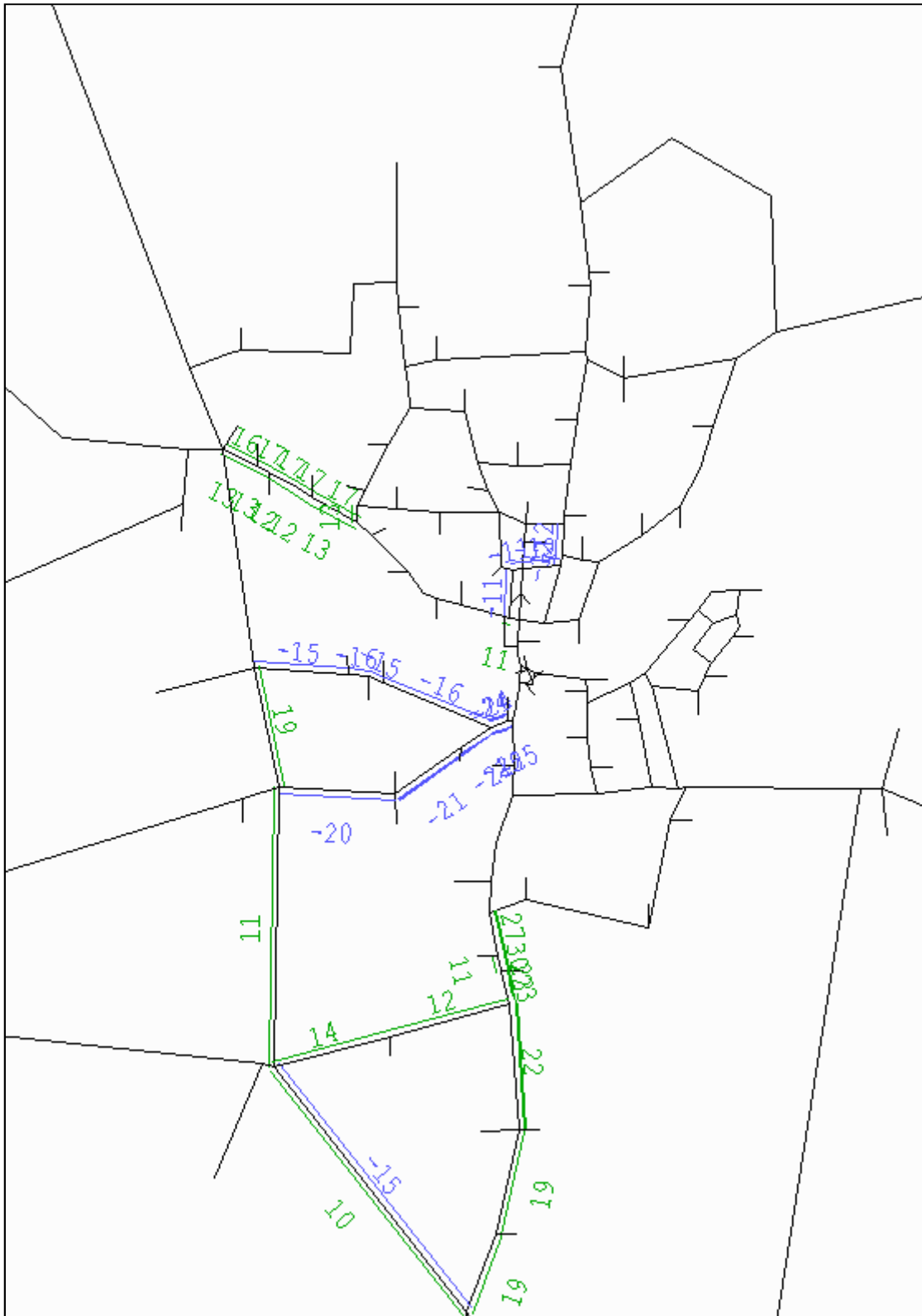

Figure F.17 – Flow Difference (2026 DM vs 2010 Base, IP)

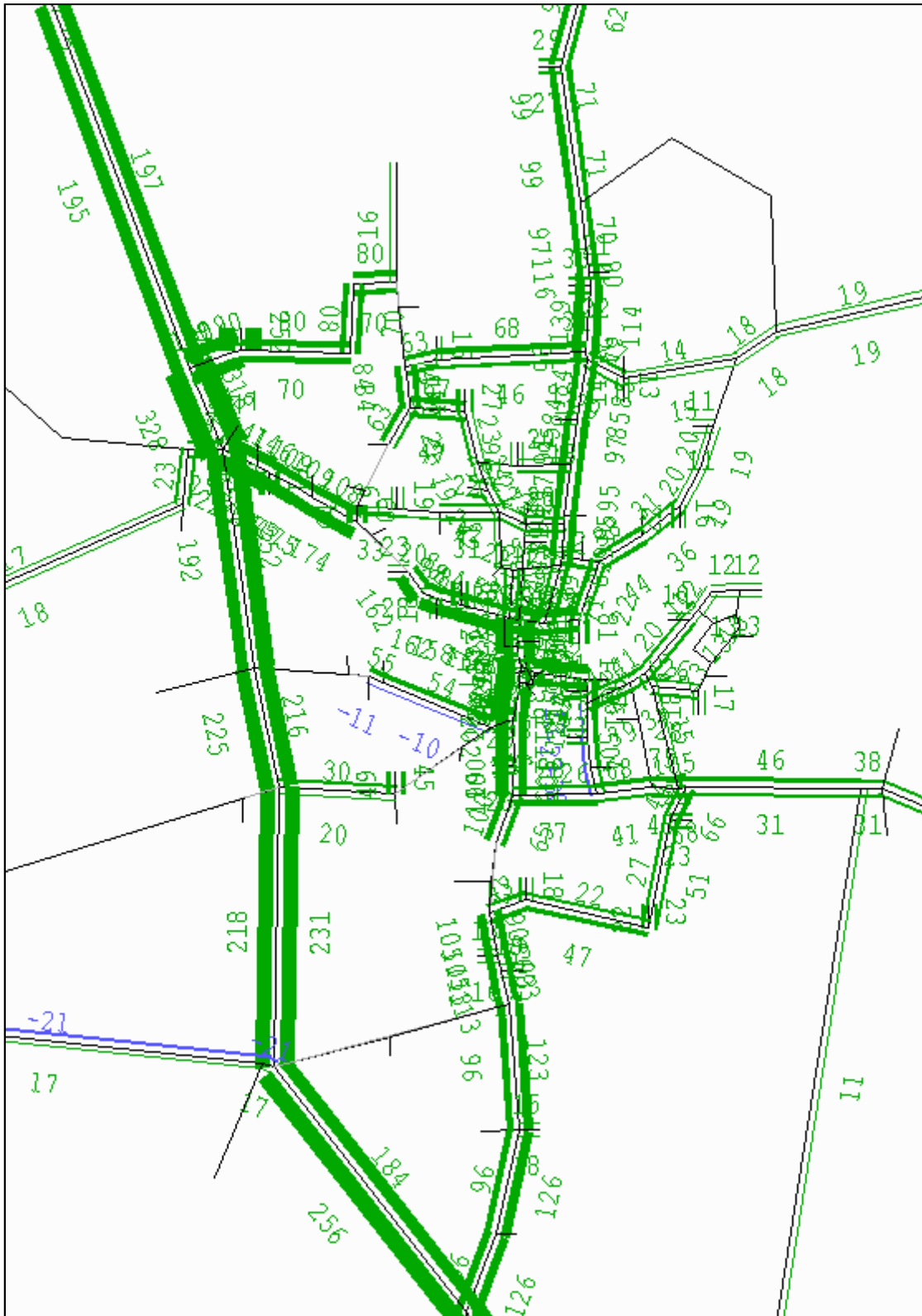

Figure F.18 – Flow Difference (2026 DM vs 2010 Base, PM)

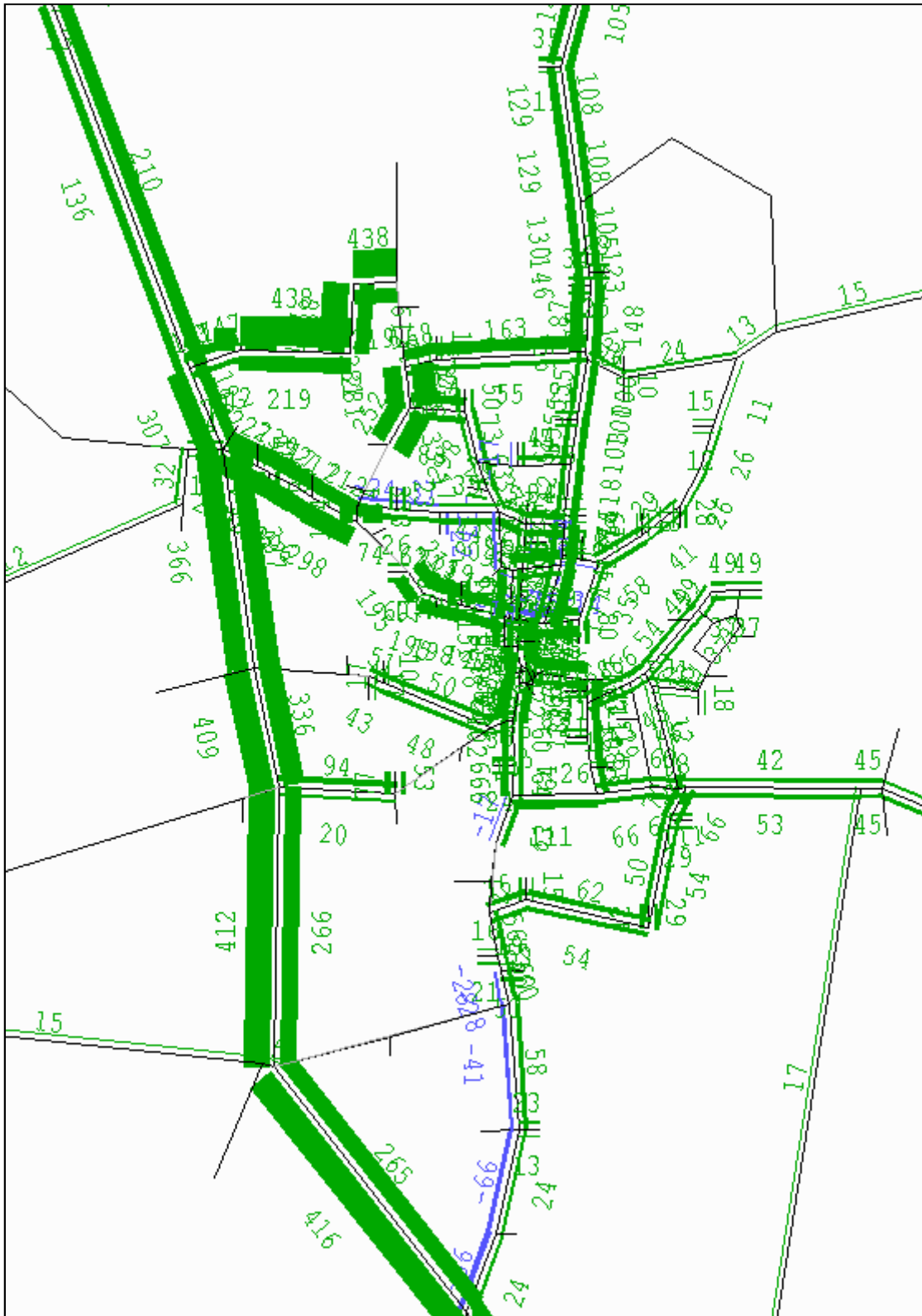

Figure F.19 – Flow Difference (2026 DS1 vs 2026 DM, AM)

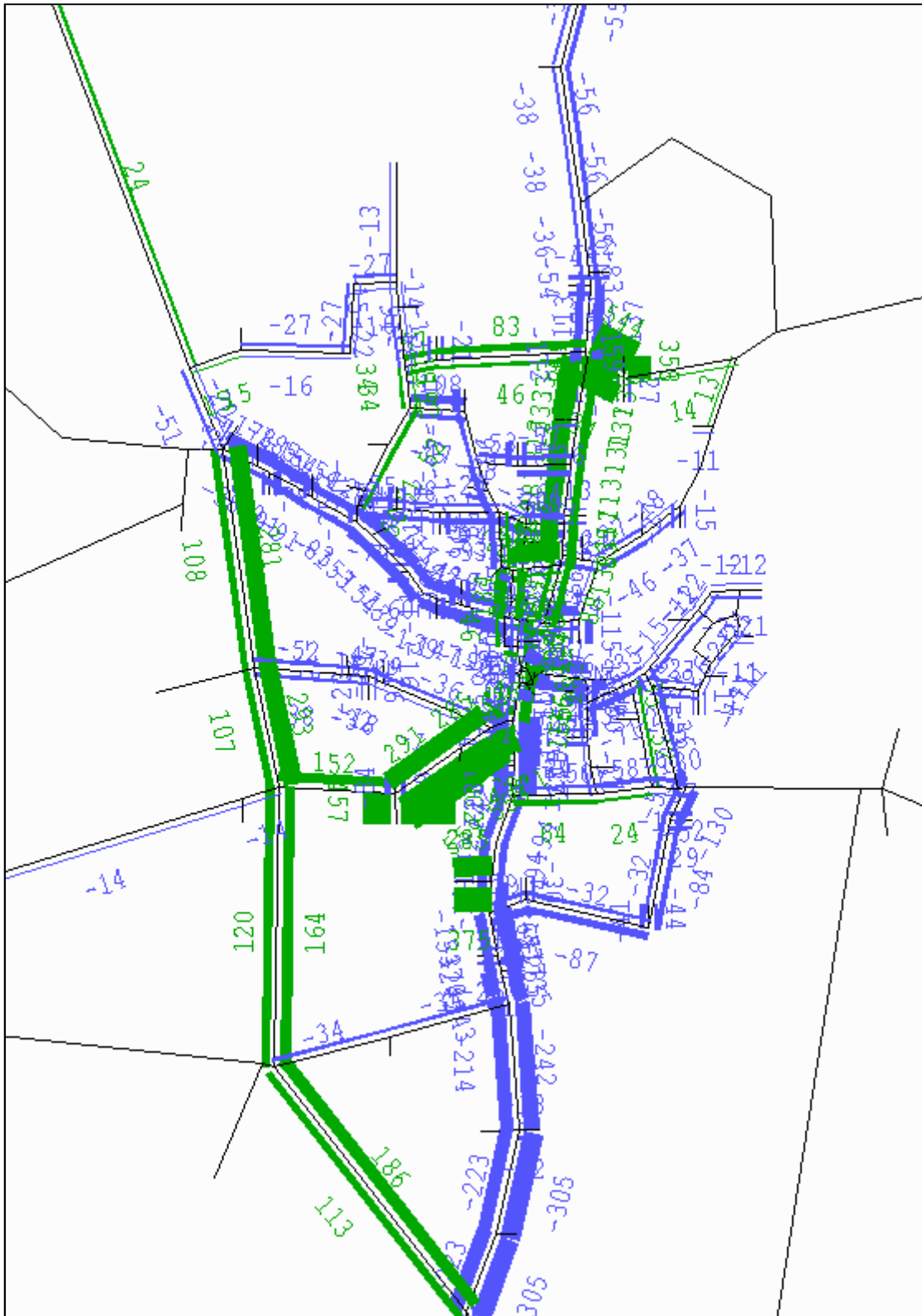

Figure F.20 – Flow Difference (2026 DS1 vs 2026 DM, IP)

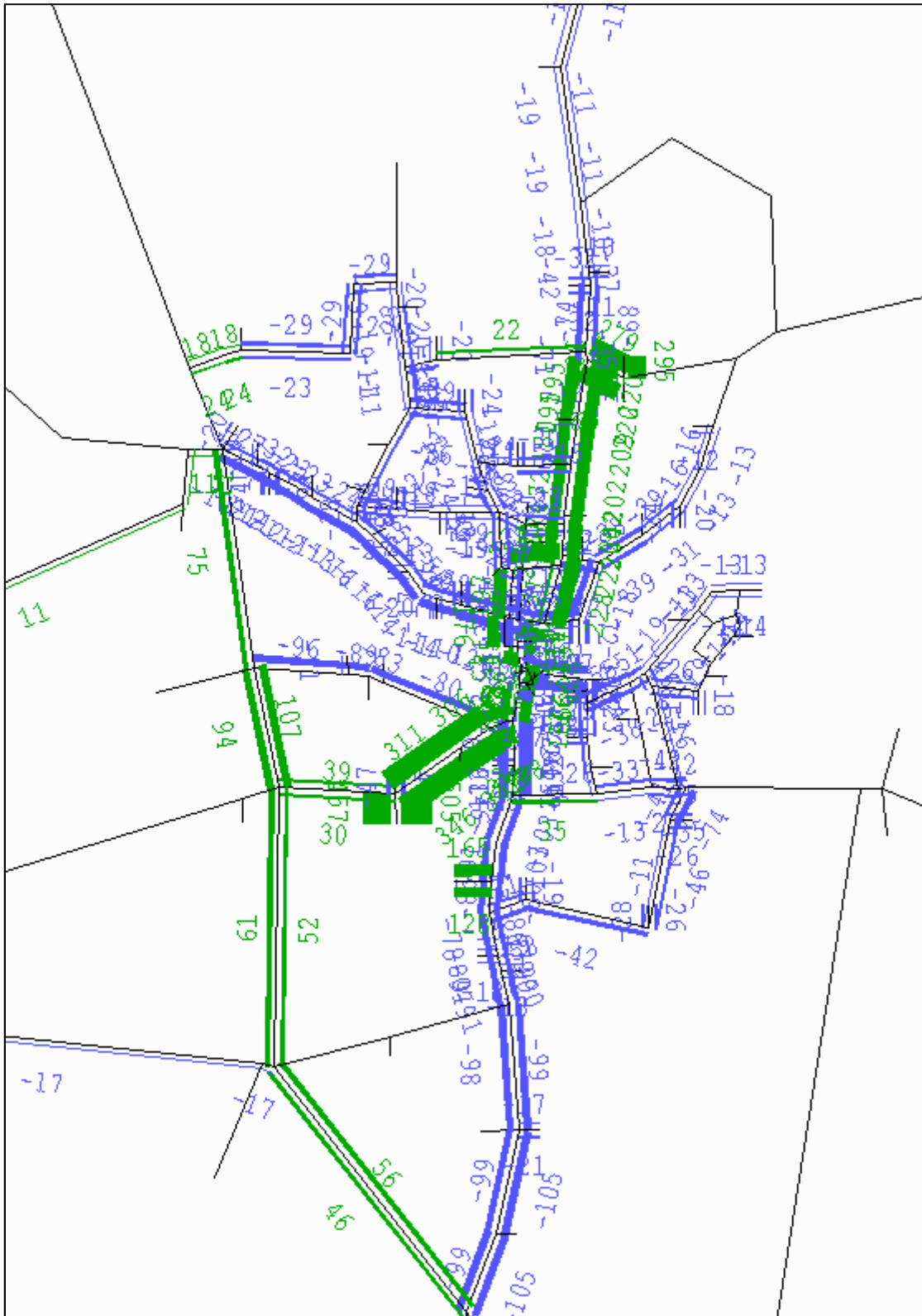

Figure F.21 – Flow Difference (2026 DS1 vs 2026 DM, PM)

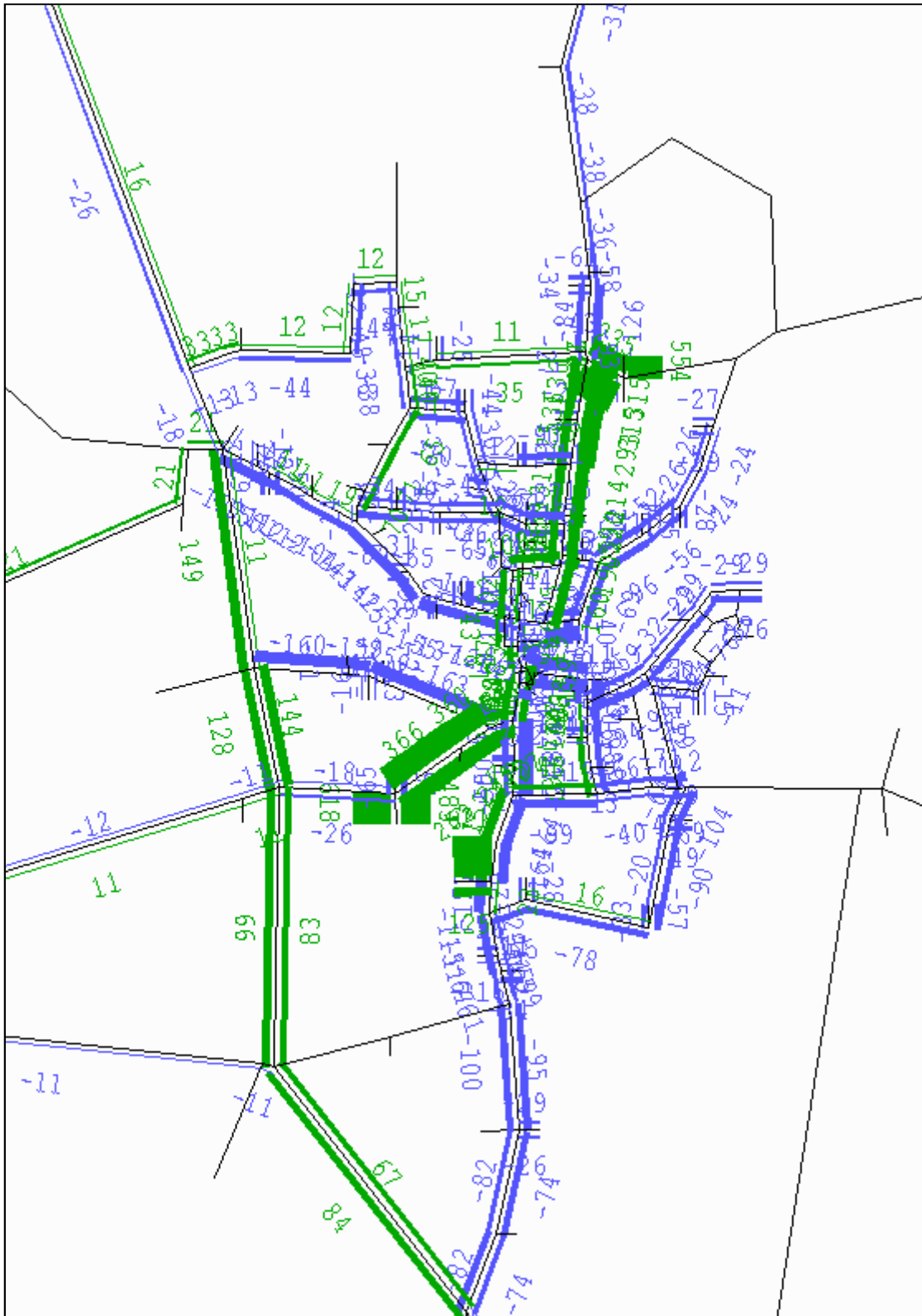

Figure F.23 – Flow Difference (2026 DS2 vs 2026 DS1, IP)

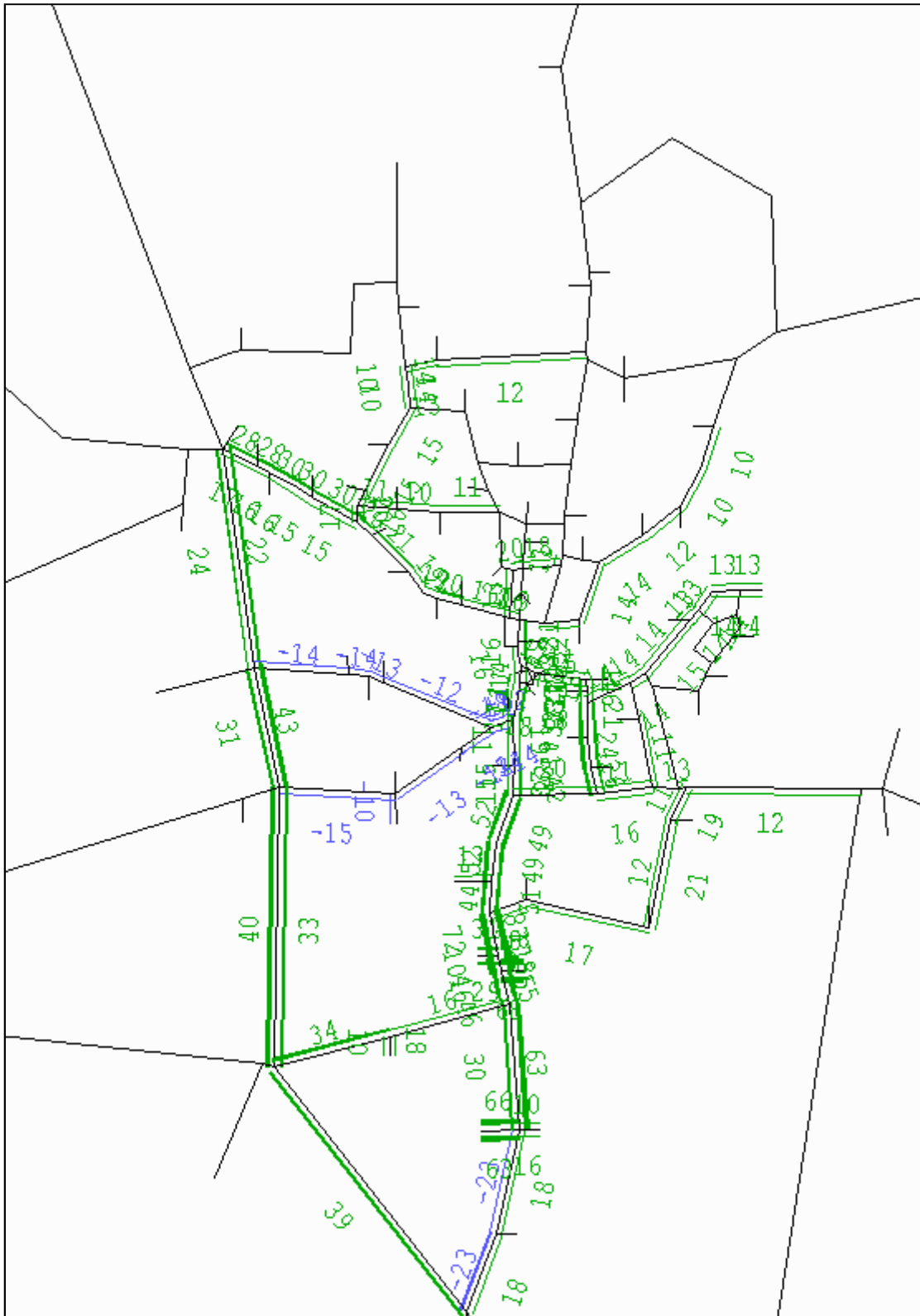
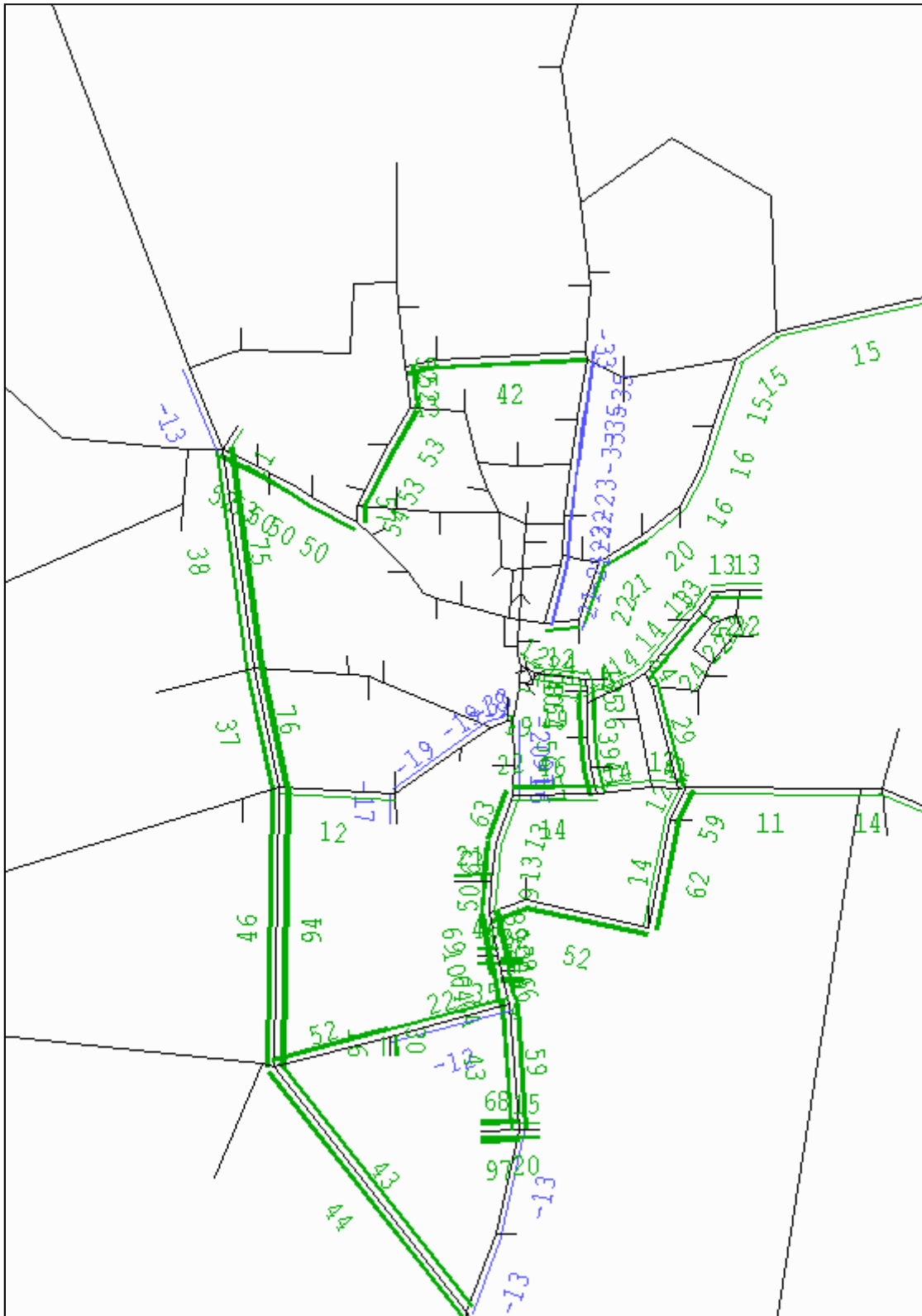

Figure F.24 – Flow Difference (2026 DS2 vs 2026 DS1, PM)



G. Journey Time Data

Journey Time Data

G.1 Cumulative modelled journey times were collated for three routes, two north-south routes and one east-west route. These routes are shown in Figure G.1 below:

- Pink Route – A141 Northbound and A141 Southbound;
- Red Route – March South to North and March North to South (via B1101); and
- Blue Route – March West to East and March East to West (via B1099/B1101).

G.2 Figure G.2 to Figure G.19 show the cumulative modelled journey time data for all forecast years, scenarios and time periods.

Figure G.1 – Journey Time Routes

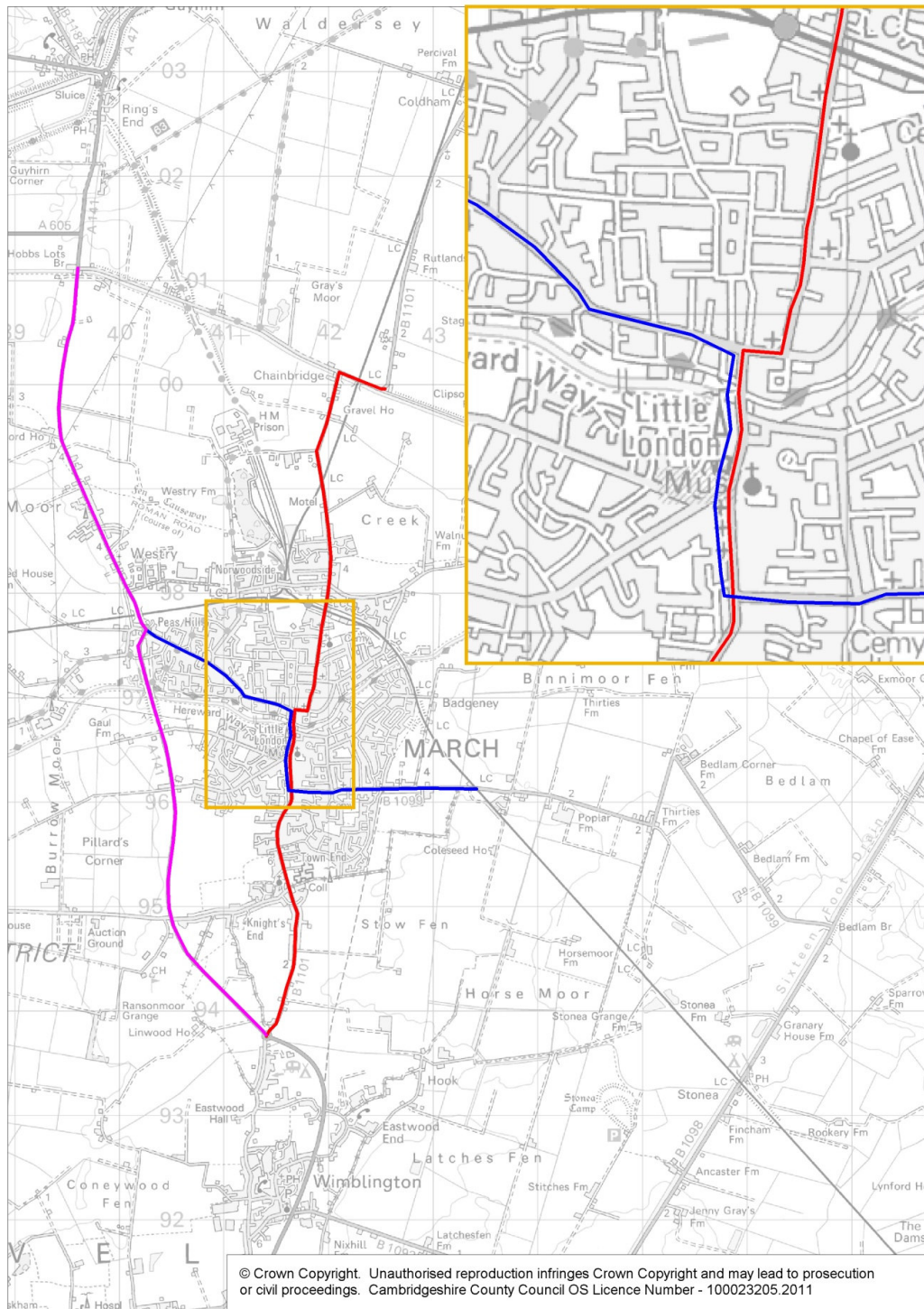

Figure G.2 – A141 Northbound (Pink Route) (AM)

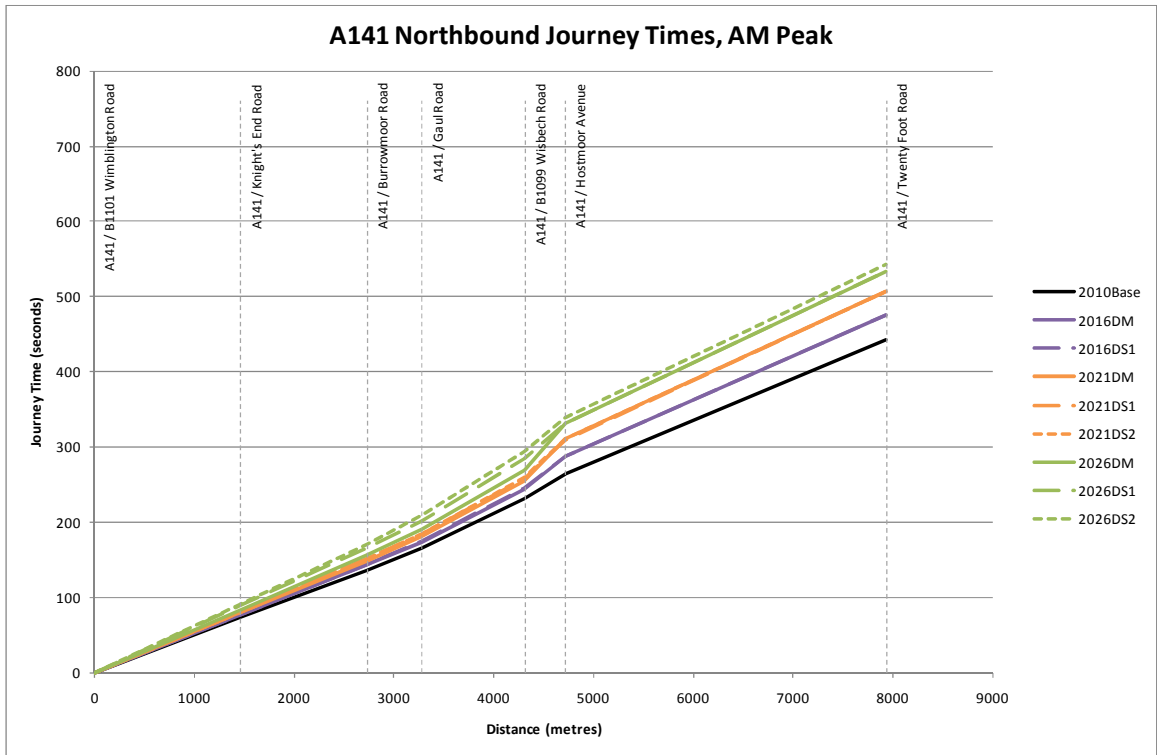

Figure G.3 – A141 Southbound (Pink Route) (AM)

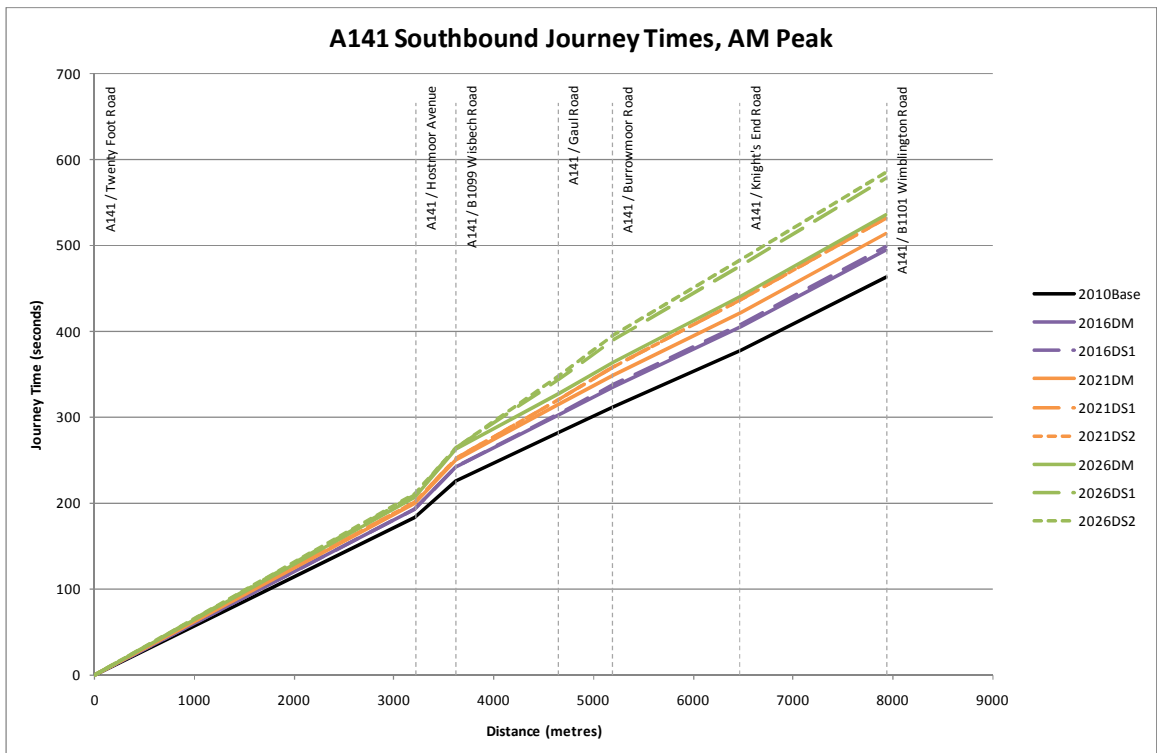

Figure G.4 – March South to North (Red Route) (AM)

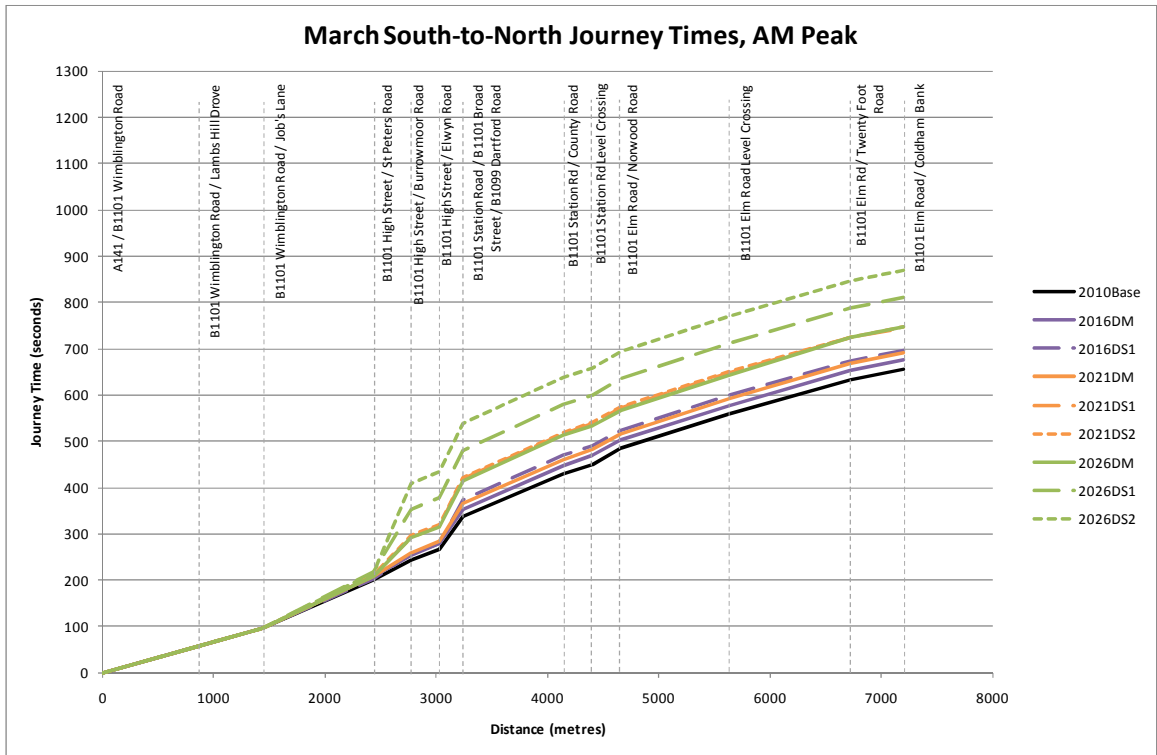

Figure G.5 – March North to South (Red Route) (AM)

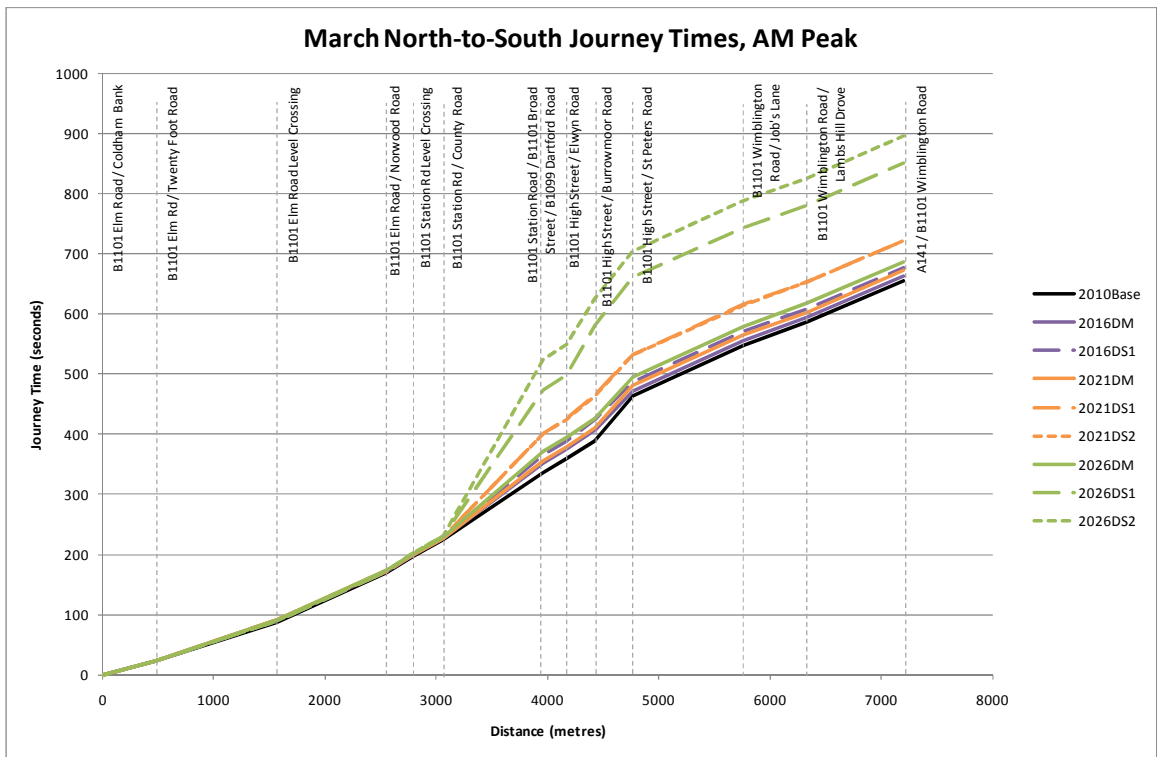

Figure G.6 – March West to East (Blue Route) (AM)

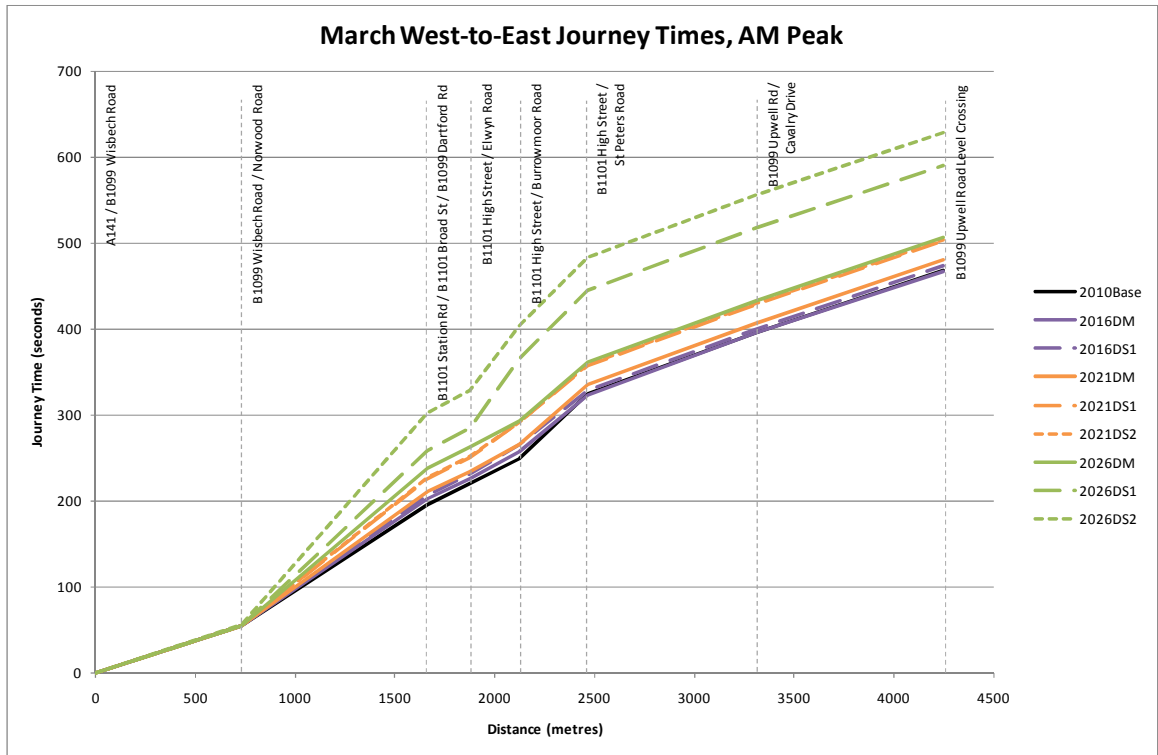

Figure G.7 – March East to West (Blue Route) (AM)

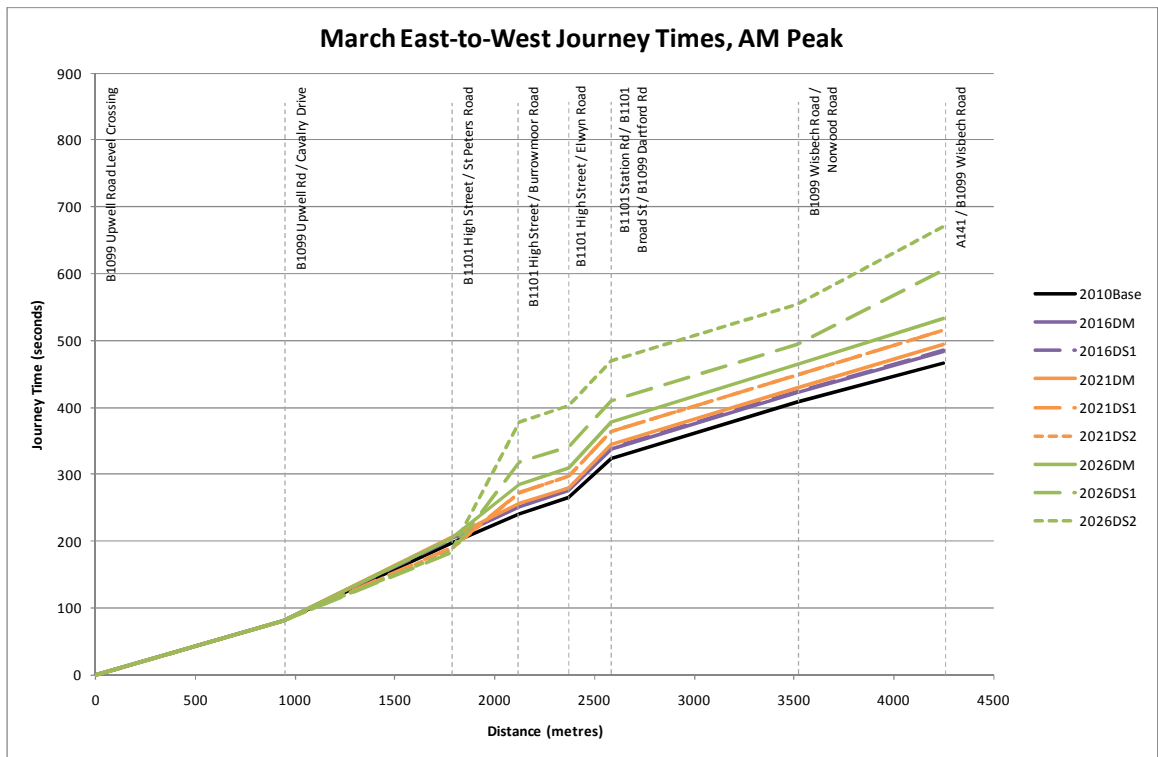

Figure G.8 – A141 Northbound (Pink Route) (IP)

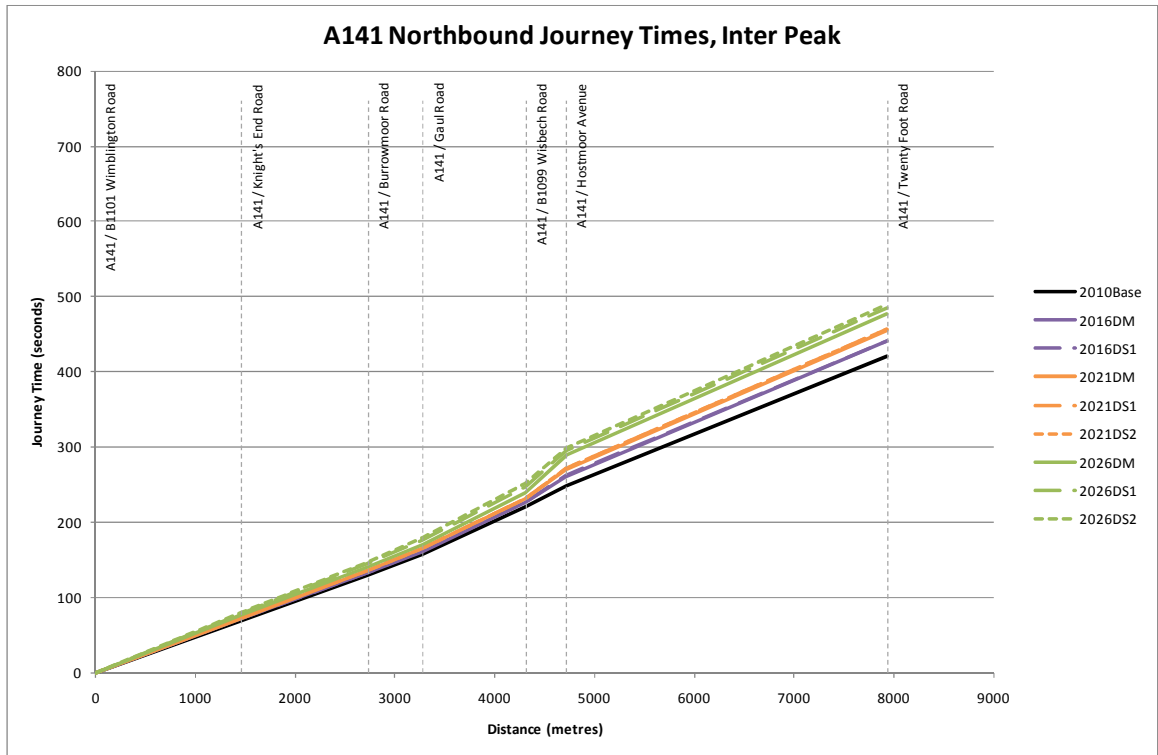

Figure G.9 – A141 Southbound (Pink Route) (IP)

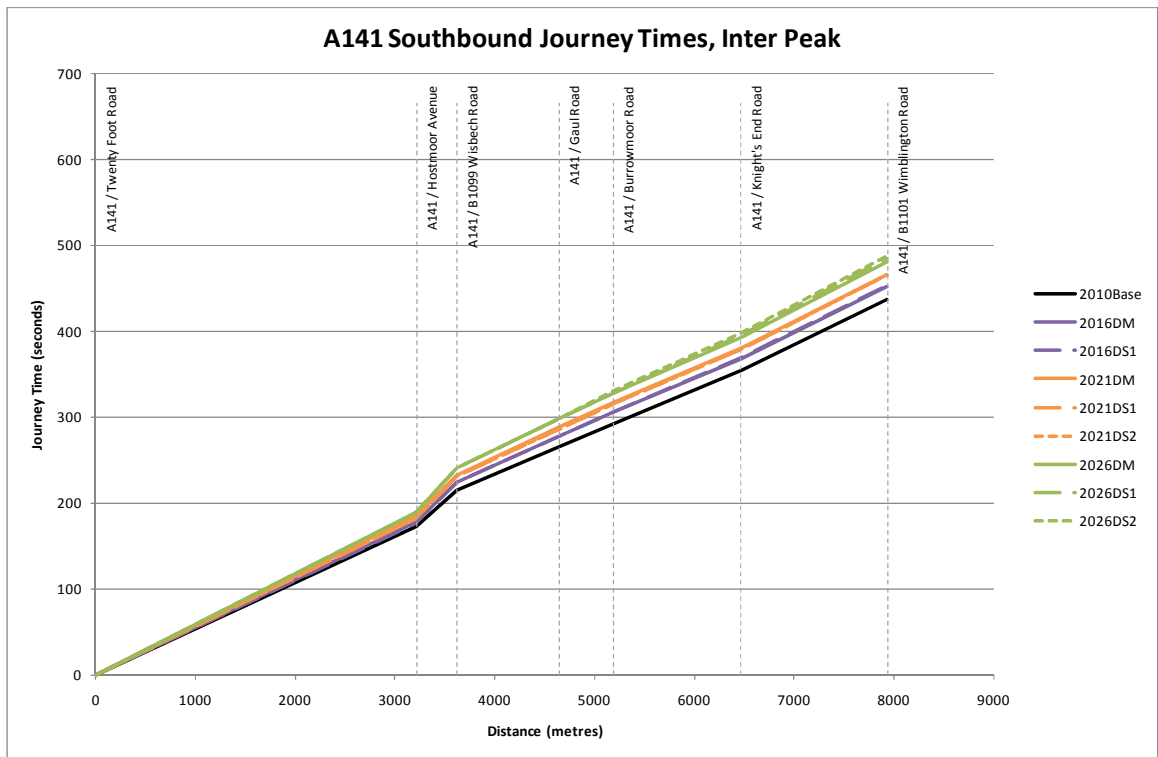

Figure G.10 – March South to North (Red Route) (IP)

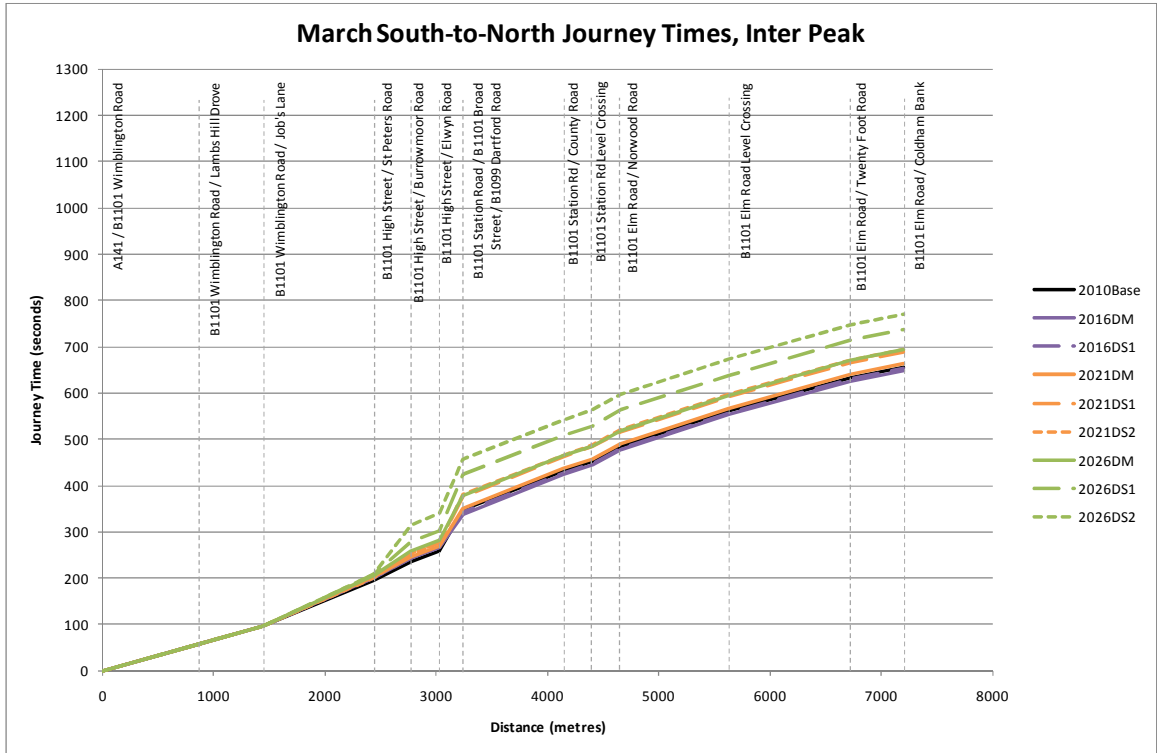

Figure G.11 – March North to South (Red Route) (IP)

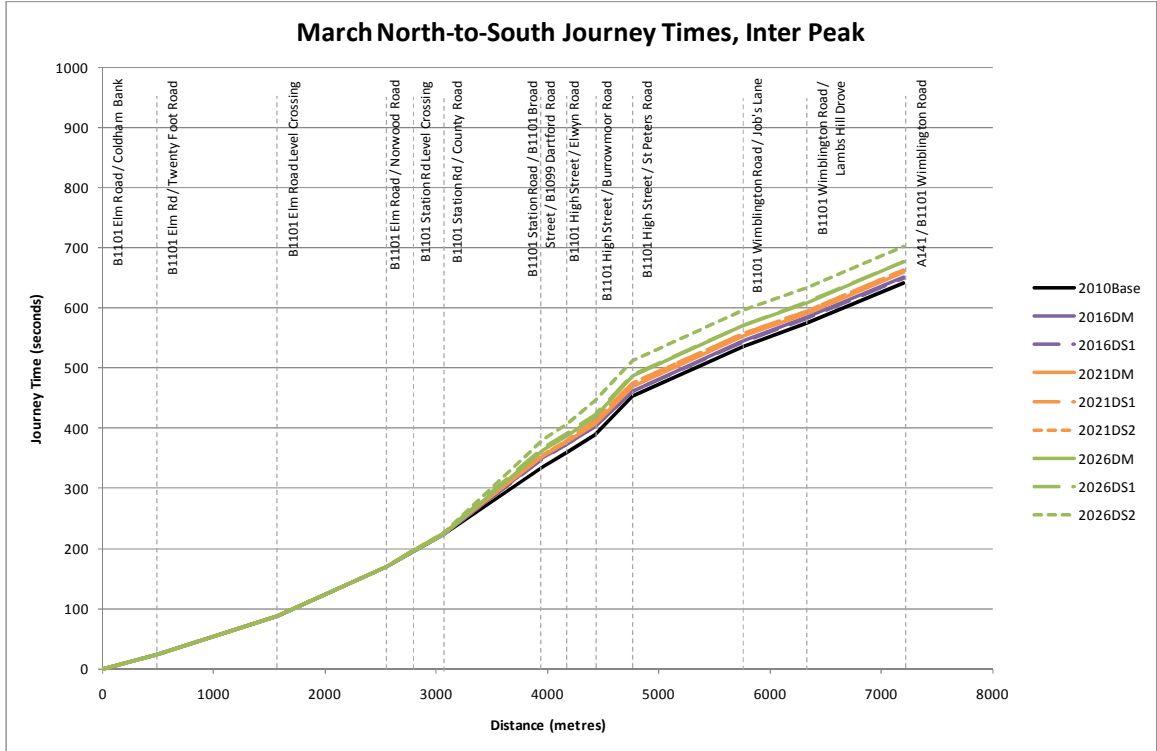

Figure G.12 – March West to East (Blue Route) (IP)

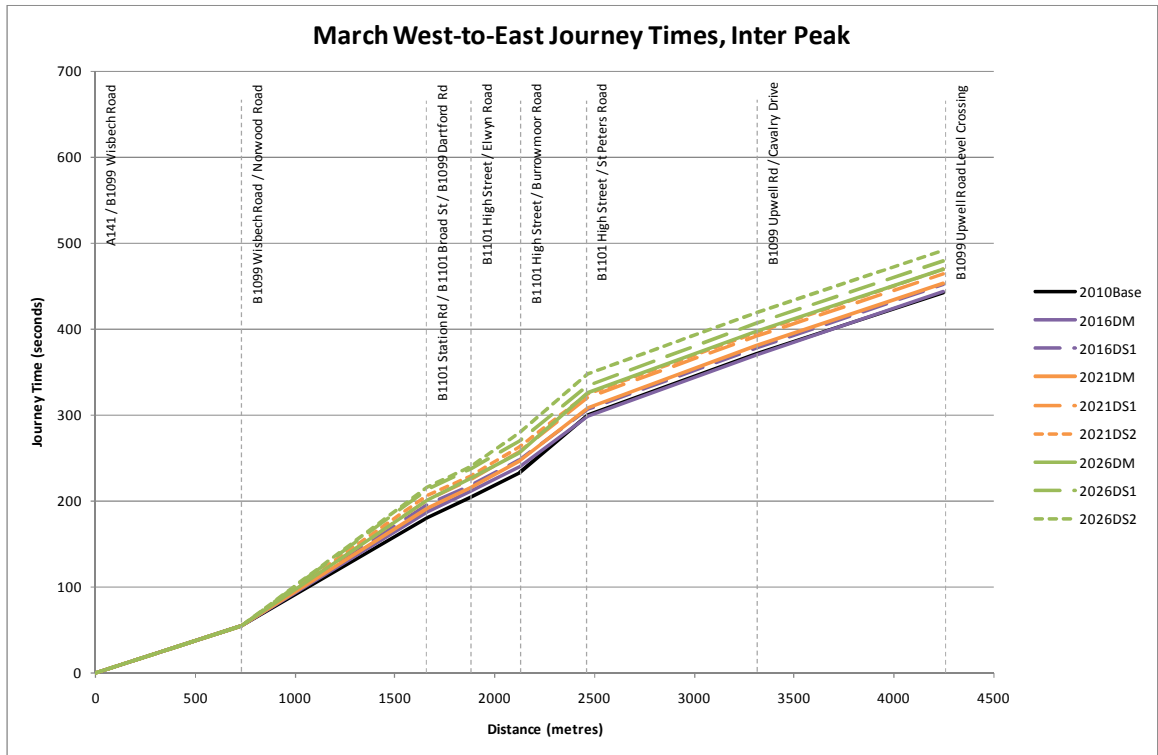

Figure G.13 – March East to West (Blue Route) (IP)

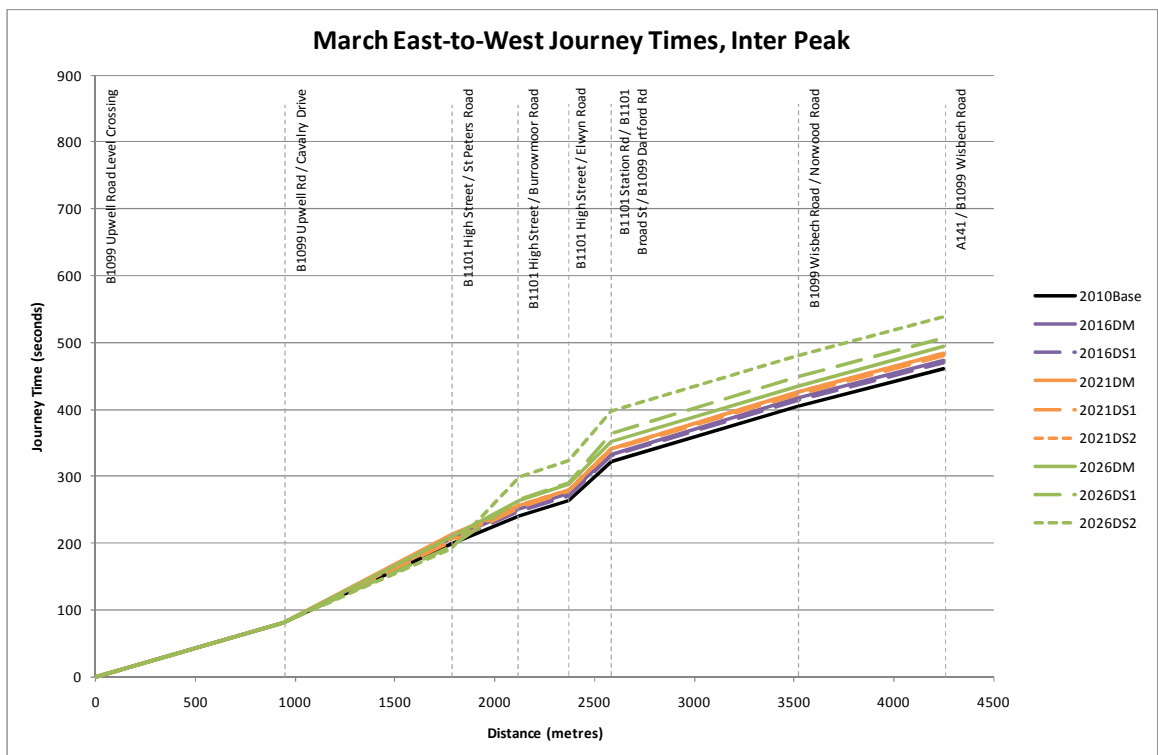

Figure G.14 – A141 Northbound (Pink Route) (PM)

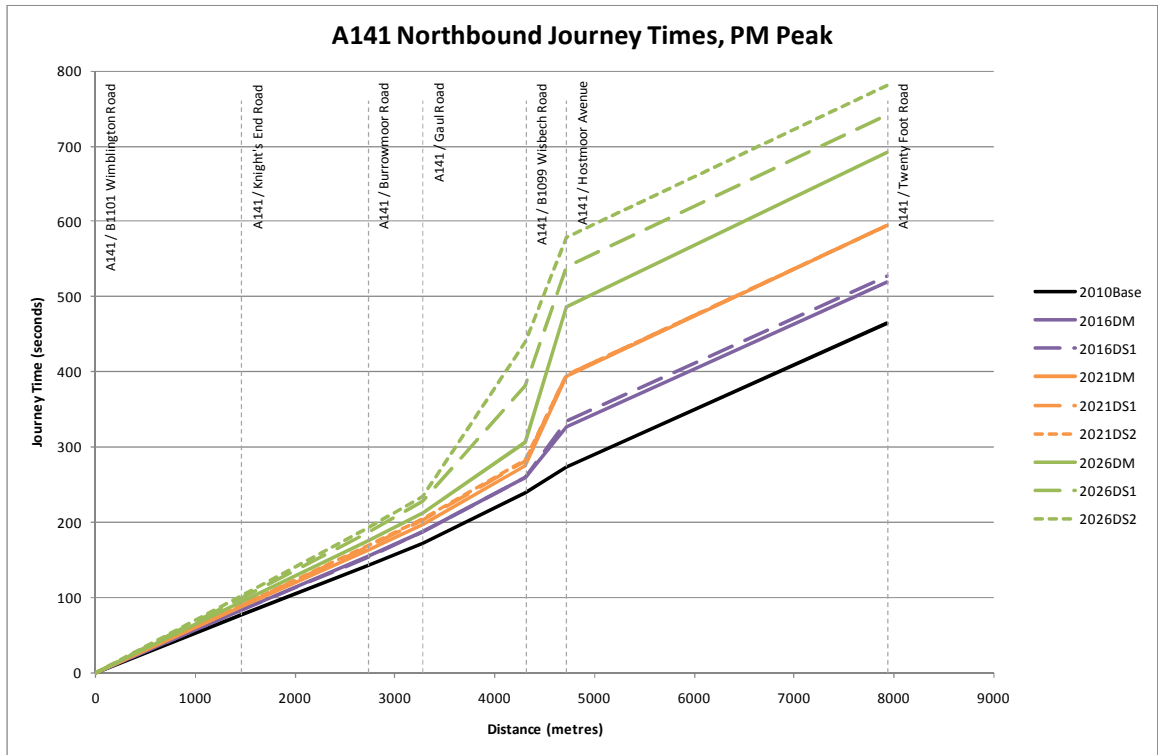

Figure G.15 – A141 Southbound (Pink Route) (PM)

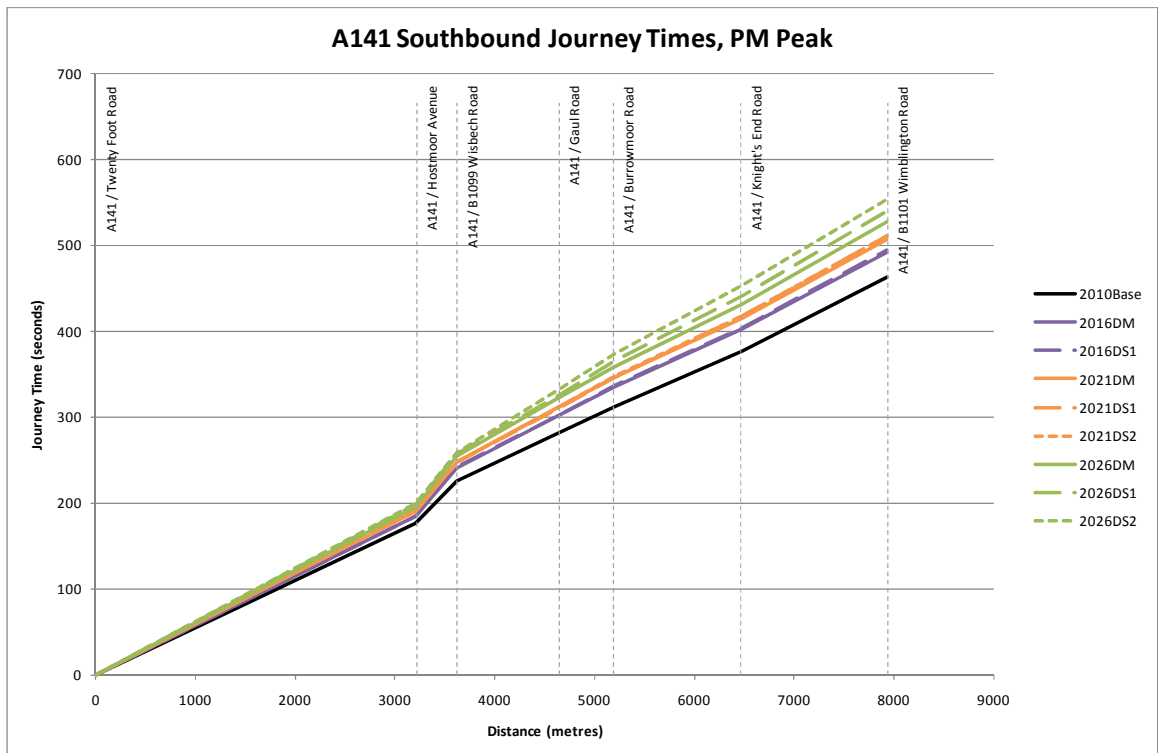

Figure G.16 – March South to North (Red Route) (PM)

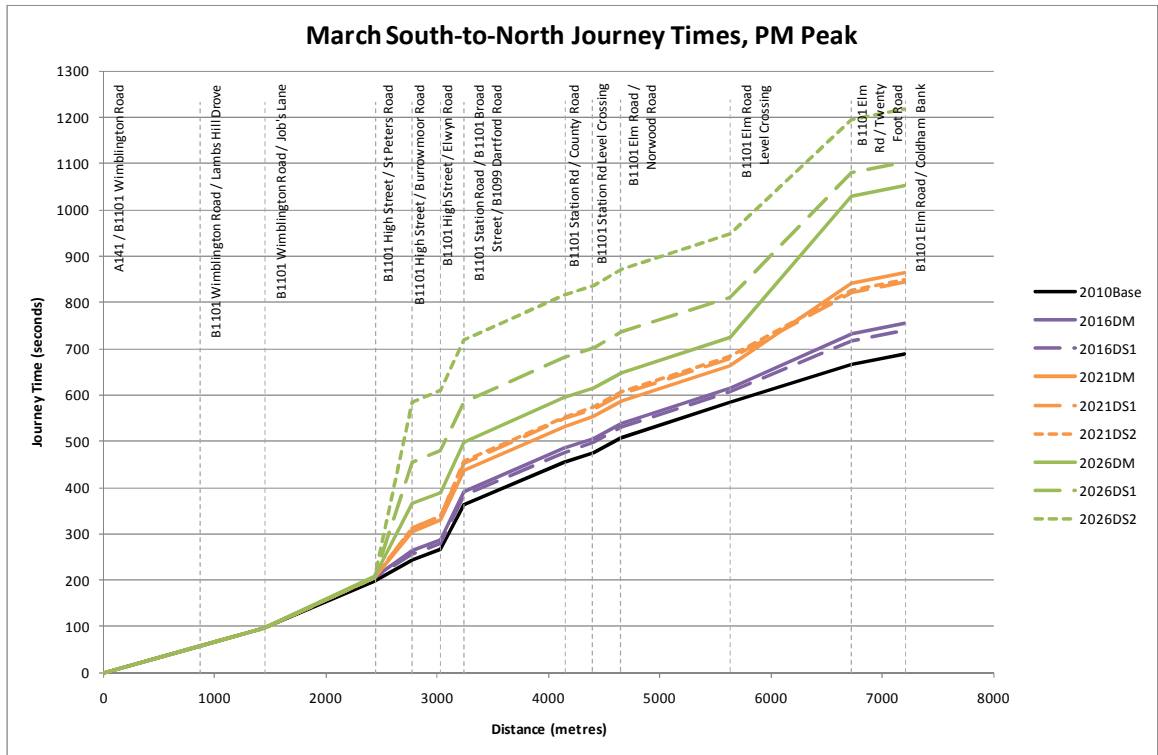

Figure G.17 – March North to South (Red Route) (PM)

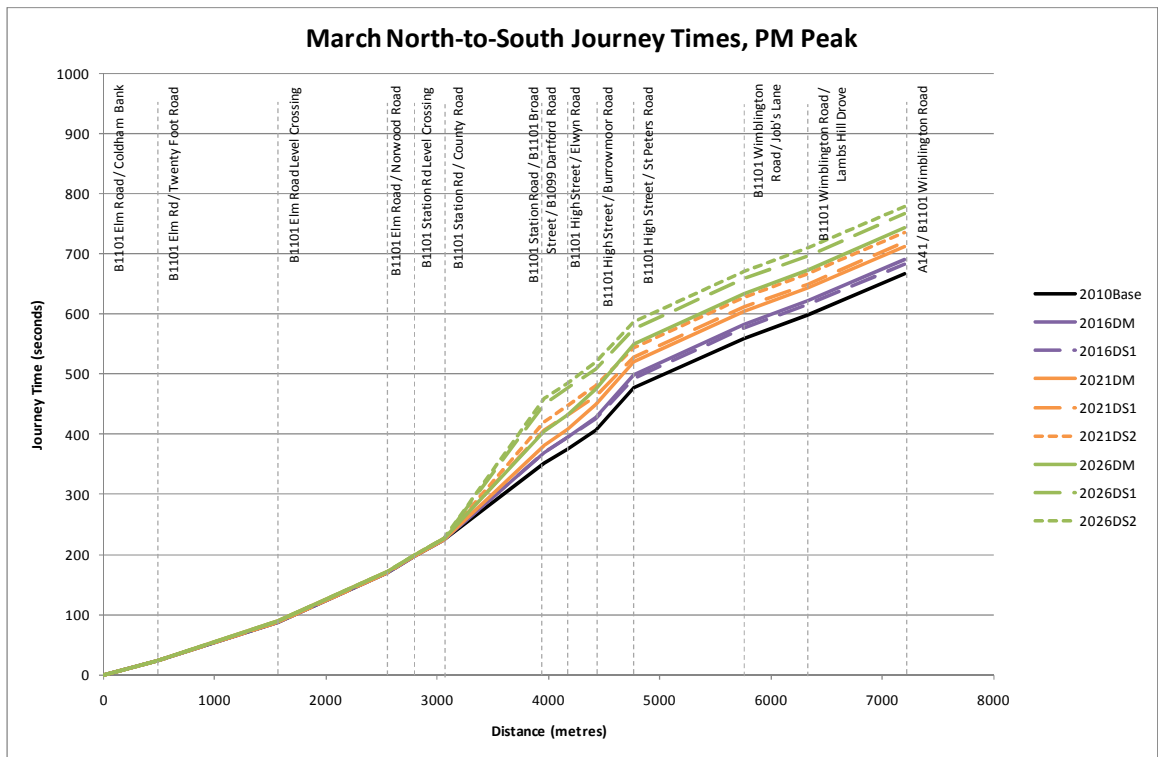

Figure G.18 – March West to East (Blue Route) (PM)

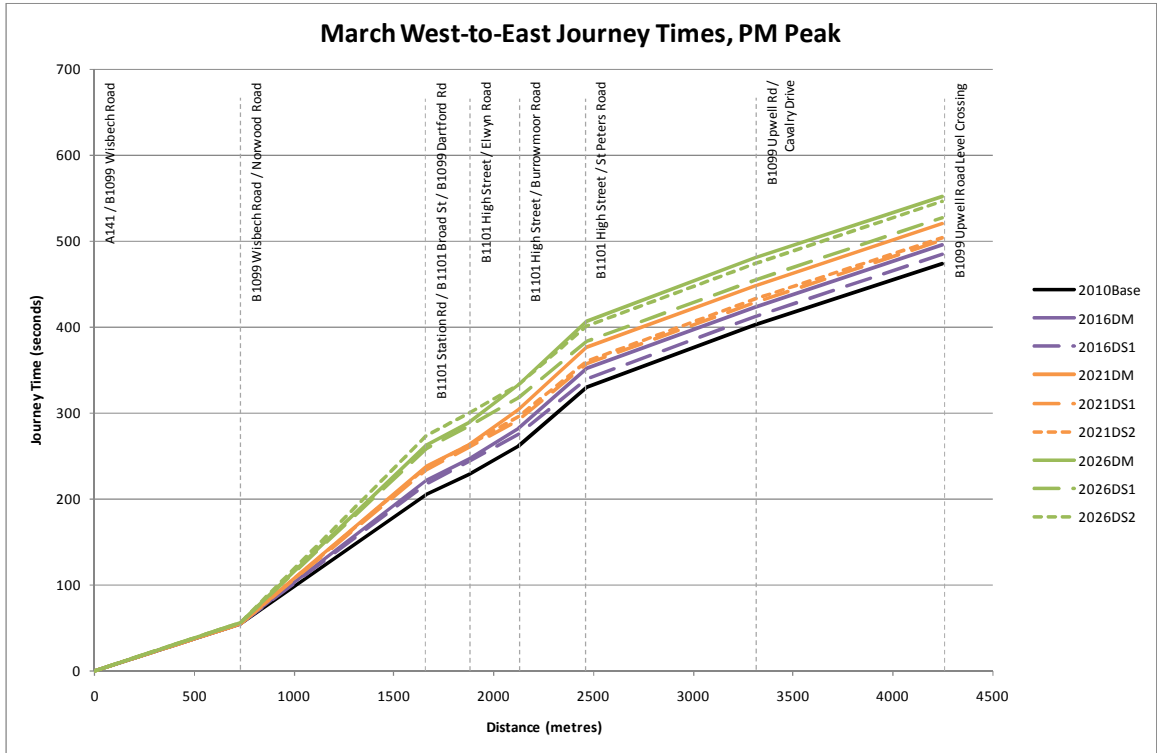
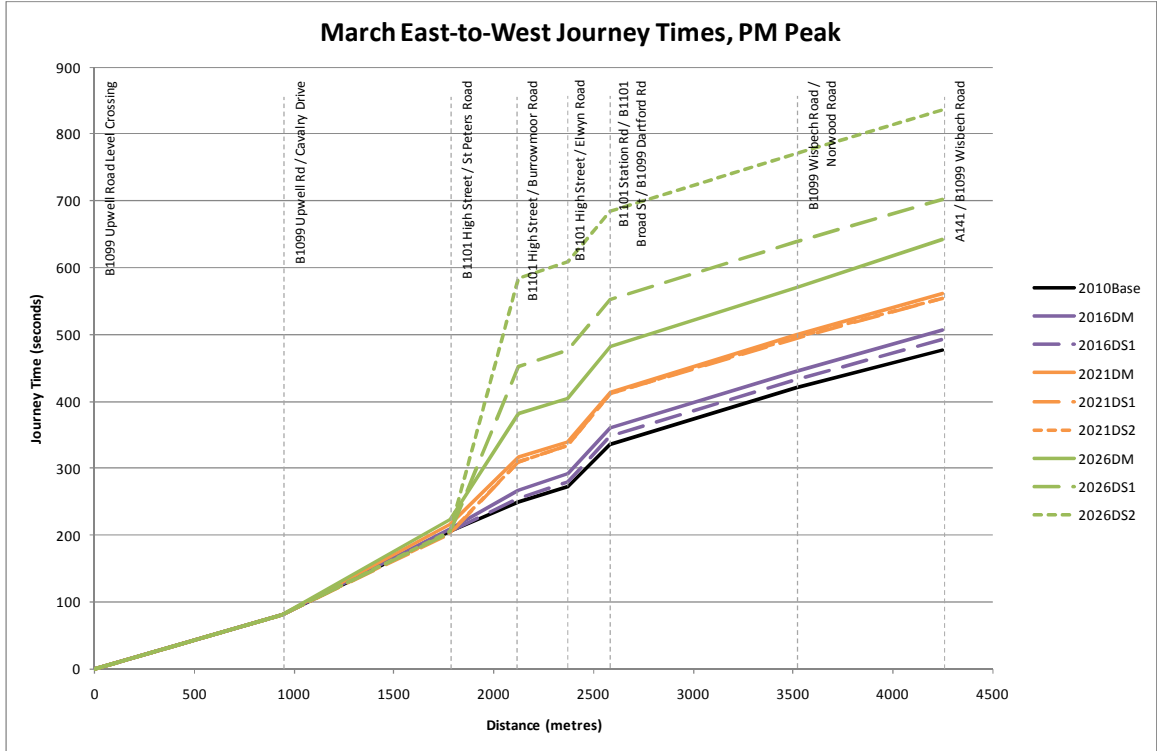

Figure G.19 – March East to West (Blue Route) (PM)



H. Junction Volume/Capacity Plots



Link and Junction Volume/Capacity Plots

- H.1 Link and junction Volume/Capacity (V/C) ratio data was extracted from the SATURN models and presented in the figures below.
- H.2 Figure H.1 to Figure H.4 show the links with high V/C (i.e. >85%) for the AM peak; Figure H.5 to Figure H.8 shows the inter peak data; and Figure H.9 to Figure H.12 shows the PM peak data (also presented in the main report (Figure 6.1 to Figure 6.4).
- H.3 For the busiest junctions, the link V/C data for all the approaches to the junctions have been extracted and presented in Table H.1 to Table H.3 below (All values above 85% have been highlighted in red). These junctions are:
- 1 – B1101 Station Road/B1101 Broad Street/B1099 Dartford Road;
 - 2 – A141/B1099 Wisbech Road;
 - 3 – A141/Hostmoor Avenue;
 - 4 – B1101 High Street/Burrowmoor Road;
 - 5 – B1101 High Street/St Peters Road;
 - 6 – A141/B1101 Wimblington Road;
 - 7 – A141/Gaul Road; and
 - 8 – B1101 Elm road/Twenty Foot Road.
- H.4 Junction V/C is the flow weighted V/C for all turning movements at the junction. Figure H.13 to Figure H.21 show the AM peak data; Figure H.22 to Figure H.30 show the inter peak data; and Figure H.31 to Figure H.39 show the PM peak data.
- H.5 Table H.4 presents the V/C values for the following junctions for all modelled scenarios. These junctions have junction V/C value of 75% or higher (i.e. Amber or red status) in one or more of the models.
- B1101 Station Road/B1101 Broad Street/B1099 Dartford Road;
 - A141/B1099 Wisbech Road;
 - A141/Hostmoor Avenue;
 - B1101 High Street/Burrowmoor Road;
 - A141/Gaul Road; and
 - A141/Burrowmoor Road.
- H.6 Junction delay (in seconds) data was also extracted for the above junctions, presented in Table H.5 to Table H.7, for information.

Table H.1 – Link V/C (AM)

Approach	2010 Base	2016 DM	2016 DS1	2021 DM	2021 DS1	2021 DS2	2026 DM	2026 DS1	2026 DS2
<i>Junction 1 – B1101 Station Road/B1101 Broad Street/B1099 Dartford Road</i>									
B1101 Station Road	70.1%	82.4%	91.2%	86.4%	98.9%	98.9%	93.2%	103.4%	106.1%
B1101 Broad Street	72.6%	78.9%	79.9%	80.7%	83.7%	83.9%	85.3%	84.9%	85.3%
B1099 Dartford Road	83.3%	88.2%	88.0%	90.8%	93.4%	93.6%	96.0%	99.1%	102.0%
<i>Junction 2 – A141/B1099 Wisbech Road</i>									
A141 (North)	66.8%	82.8%	81.6%	88.5%	86.9%	86.9%	93.7%	92.3%	92.5%
Retail Access	3.0%	4.2%	3.6%	5.0%	3.6%	3.6%	5.8%	4.5%	5.8%
B1099 Wisbech Road	60.2%	79.8%	79.3%	88.4%	89.8%	90.2%	92.5%	101.1%	101.4%
A141 (South)	59.9%	74.3%	73.7%	83.4%	81.7%	82.2%	90.1%	91.1%	94.1%
Whittlesey Road	7.8%	11.4%	10.9%	14.1%	12.6%	12.7%	16.6%	14.8%	15.0%
<i>Junction 3 – A141/Hostmoor Avenue</i>									
A141 (North)	61.6%	68.4%	68.5%	72.7%	73.5%	73.5%	76.6%	78.3%	78.5%
Hostmoor Avenue	34.6%	69.2%	68.0%	80.2%	78.3%	78.3%	91.6%	90.1%	90.5%
A141 (South)	78.1%	90.5%	89.9%	95.6%	94.7%	94.7%	97.2%	93.5%	92.5%
<i>Junction 4 – B1101 High Street/Burrowmoor Road</i>									
B1101 High Street (North)	63.9%	80.8%	94.3%	82.6%	100.0%	99.9%	84.3%	102.4%	102.1%
B1101 High Street (South)	74.3%	91.7%	88.4%	95.7%	99.7%	100.0%	101.0%	102.5%	105.7%
Burrowmoor Road	66.8%	93.9%	92.4%	99.5%	100.0%	100.0%	100.0%	100.0%	100.0%
<i>Junction 5 – B1101 High Street/St Peters Road</i>									
B1101 High Street (North)	71.0%	66.0%	57.3%	70.9%	47.6%	48.6%	67.1%	51.9%	54.1%
B1099 St Peters Road	55.6%	69.3%	65.1%	74.2%	60.7%	59.0%	74.9%	59.9%	62.2%
B1101 High Street (South)	36.2%	39.1%	32.5%	41.5%	34.8%	36.1%	42.6%	38.2%	44.0%
<i>Junction 6 – A141/B1101 Wimblington Road</i>									
B1101 Wimblington road	46.5%	55.2%	50.0%	61.8%	47.1%	47.0%	67.7%	43.6%	48.1%
A141 (East)	51.1%	58.3%	57.0%	63.7%	61.0%	61.0%	69.4%	65.2%	66.9%
March Road	36.9%	40.3%	39.2%	43.2%	40.4%	40.4%	46.9%	43.0%	43.4%
A141 (West)	48.1%	56.9%	57.7%	61.4%	66.2%	66.3%	68.1%	73.6%	73.7%
<i>Junction 7 – A141/Gaul Road</i>									
A141 (North)	51.2%	61.4%	64.7%	65.8%	73.4%	73.5%	69.3%	86.3%	88.4%
Gaul Road (East)	36.7%	45.7%	39.9%	65.3%	83.3%	82.7%	86.5%	95.7%	100.8%
A141 (South)	42.5%	50.0%	51.6%	55.5%	58.0%	58.3%	60.9%	67.3%	70.8%
Gaul Road (West)	0.0%	0.0%	0.0%	0.0%	0.0%	0.0%	0.0%	0.0%	0.0%
<i>Junction 8 – B1101 Elm Road/Twenty Foot Road</i>									
Twenty Foot Road	14.0%	17.8%	16.9%	19.2%	16.7%	16.7%	20.2%	16.2%	16.2%
B1101 Elm Road (East)	11.0%	14.6%	14.2%	15.6%	14.9%	14.9%	18.7%	17.2%	17.2%
B1101 Elm Road (South)	35.0%	44.0%	41.3%	51.5%	43.9%	44.1%	64.6%	53.0%	53.0%

Table H.2 – Link V/C (IP)

Approach	2010 Base	2016 DM	2016 DS1	2021 DM	2021 DS1	2021 DS2	2026 DM	2026 DS1	2026 DS2
<i>Junction 1 – B1101 Station Road/B1101 Broad Street/B1099 Dartford Road</i>									
B1101 Station Road	59.4%	77.0%	78.6%	81.1%	86.6%	86.9%	87.9%	93.2%	96.5%
B1101 Broad Street	65.2%	67.4%	65.4%	73.0%	72.7%	73.3%	79.1%	83.6%	83.1%
B1099 Dartford Road	68.4%	76.4%	77.9%	81.0%	80.7%	82.8%	86.8%	86.9%	88.8%
<i>Junction 2 – A141/B1099 Wisbech Road</i>									
A141 (North)	65.9%	77.1%	76.9%	83.4%	82.2%	82.1%	88.9%	88.8%	89.0%
Retail Access	5.7%	7.4%	6.7%	8.8%	7.2%	7.3%	10.6%	8.6%	9.7%
B1099 Wisbech Road	37.6%	49.9%	48.0%	57.4%	51.0%	51.4%	66.0%	57.8%	59.7%
A141 (South)	47.3%	57.1%	57.4%	63.0%	63.5%	63.5%	70.0%	74.2%	76.1%
Whittlesey Road	6.7%	9.1%	9.5%	11.0%	11.5%	11.5%	13.3%	14.7%	15.5%
<i>Junction 3 – A141/Hostmoor Avenue</i>									
A141 (North)	51.4%	57.5%	57.3%	62.0%	61.0%	60.8%	65.7%	65.9%	66.0%
Hostmoor Avenue	48.1%	67.4%	67.7%	77.9%	77.4%	77.3%	88.5%	89.7%	90.1%
A141 (South)	70.1%	82.5%	82.2%	88.4%	88.0%	88.1%	93.8%	93.8%	93.5%
<i>Junction 4 – B1101 High Street/Burrowmoor Road</i>									
B1101 High Street (North)	58.2%	70.5%	74.3%	75.4%	90.9%	91.5%	80.1%	95.0%	99.7%
B1101 High Street (South)	61.6%	69.3%	67.4%	82.6%	85.2%	85.3%	96.8%	97.0%	101.3%
Burrowmoor Road	48.8%	62.2%	69.8%	74.2%	94.8%	96.0%	90.7%	99.6%	100.0%
<i>Junction 5 – B1101 High Street/St Peters Road</i>									
B1101 High Street (North)	61.4%	58.0%	54.0%	64.3%	58.0%	57.0%	73.7%	52.5%	58.5%
B1099 St Peters Road	56.6%	56.6%	54.4%	69.9%	66.2%	67.3%	77.8%	69.9%	69.2%
B1101 High Street (South)	31.0%	33.0%	31.1%	37.9%	34.1%	33.9%	42.4%	36.6%	42.6%
<i>Junction 6 – A141/B1101 Wimblington Road</i>									
B1101 Wimblington road	31.7%	35.2%	33.2%	38.5%	35.0%	35.1%	45.4%	37.9%	39.5%
A141 (East)	43.2%	49.8%	49.4%	54.9%	53.9%	54.0%	61.2%	59.3%	59.8%
March Road	25.6%	28.7%	28.4%	31.4%	30.5%	30.6%	34.6%	33.3%	33.5%
A141 (West)	36.3%	42.0%	42.9%	46.8%	47.4%	47.5%	51.7%	53.2%	52.6%
<i>Junction 7 – A141/Gaul Road</i>									
A141 (North)	39.0%	45.6%	47.0%	49.9%	50.4%	50.8%	54.2%	54.0%	55.3%
Gaul Road (East)	29.0%	34.5%	32.6%	35.5%	31.2%	31.0%	31.6%	34.3%	37.1%
A141 (South)	32.9%	38.0%	39.0%	41.6%	43.7%	43.7%	46.4%	52.1%	54.0%
Gaul Road (West)	0.0%	0.0%	0.0%	0.0%	0.0%	0.0%	0.0%	0.0%	0.0%
<i>Junction 8 – B1101 Elm Road/Twenty Foot Road</i>									
Twenty Foot Road	7.0%	7.7%	7.6%	8.8%	9.5%	9.7%	11.3%	10.3%	10.3%
B1101 Elm Road (East)	6.2%	6.8%	6.8%	7.4%	7.4%	7.4%	8.0%	8.0%	8.0%
B1101 Elm Road (South)	31.1%	34.3%	33.9%	40.7%	39.3%	39.4%	52.7%	48.6%	48.9%

Table H.3 – Link V/C (PM)

Approach	2010 Base	2016 DM	2016 DS1	2021 DM	2021 DS1	2021 DS2	2026 DM	2026 DS1	2026 DS2
<i>Junction 1 – B1101 Station Road/B1101 Broad Street/B1099 Dartford Road</i>									
B1101 Station Road	85.3%	93.2%	93.9%	96.6%	99.6%	100.7%	99.6%	102.2%	102.7%
B1101 Broad Street	74.8%	82.4%	81.9%	85.1%	87.5%	87.5%	87.3%	85.8%	85.9%
B1099 Dartford Road	88.3%	92.9%	92.2%	95.9%	95.4%	95.9%	99.4%	98.9%	100.3%
<i>Junction 2 – A141/B1099 Wisbech Road</i>									
A141 (North)	83.5%	94.5%	94.5%	95.4%	95.5%	95.5%	96.7%	96.9%	97.1%
Retail Access	6.0%	8.1%	6.6%	9.4%	6.4%	6.5%	11.1%	7.0%	9.6%
B1099 Wisbech Road	55.9%	70.5%	64.0%	78.2%	62.8%	64.2%	93.7%	79.3%	86.0%
A141 (South)	63.0%	77.9%	78.3%	87.0%	87.4%	88.2%	98.9%	102.9%	105.6%
Whittlesey Road	12.5%	19.0%	19.3%	23.3%	24.4%	25.2%	30.1%	33.3%	33.9%
<i>Junction 3 – A141/Hostmoor Avenue</i>									
A141 (North)	55.0%	62.7%	62.5%	66.1%	66.5%	66.6%	70.2%	71.4%	72.0%
Hostmoor Avenue	76.6%	108.1%	108.3%	109.8%	111.4%	111.0%	111.7%	110.3%	110.5%
A141 (South)	82.9%	97.7%	98.6%	101.7%	101.4%	101.3%	105.1%	103.8%	102.8%
<i>Junction 4 – B1101 High Street/Burrowmoor Road</i>									
B1101 High Street (North)	76.2%	89.5%	84.8%	95.8%	96.8%	96.4%	97.7%	98.2%	98.6%
B1101 High Street (South)	81.2%	98.2%	91.2%	101.7%	101.7%	101.7%	104.9%	109.3%	112.1%
Burrowmoor Road	70.4%	89.9%	96.5%	97.4%	100.0%	100.0%	100.0%	100.0%	100.0%
<i>Junction 5 – B1101 High Street/St Peters Road</i>									
B1101 High Street (North)	69.8%	74.0%	63.5%	76.0%	55.0%	55.4%	78.7%	49.8%	51.6%
B1099 St Peters Road	64.4%	74.5%	69.7%	81.8%	68.7%	70.9%	86.8%	65.4%	70.0%
B1101 High Street (South)	38.0%	39.7%	38.5%	40.8%	42.3%	42.5%	41.5%	45.4%	49.3%
<i>Junction 6 – A141/B1101 Wimblington Road</i>									
B1101 Wimblington road	42.6%	46.7%	43.9%	51.3%	44.1%	45.4%	52.5%	47.4%	47.5%
A141 (East)	66.3%	76.9%	75.6%	83.5%	81.8%	81.8%	90.2%	89.8%	91.5%
March Road	33.0%	36.1%	35.7%	39.1%	38.5%	38.6%	43.4%	41.9%	43.8%
A141 (West)	49.7%	56.6%	58.0%	61.0%	64.1%	62.8%	67.1%	69.2%	72.0%
<i>Junction 7 – A141/Gaul Road</i>									
A141 (North)	54.6%	64.1%	62.8%	69.2%	65.8%	66.1%	74.4%	75.0%	79.5%
Gaul Road (East)	27.4%	32.4%	27.7%	52.4%	42.1%	40.5%	67.0%	76.6%	88.5%
A141 (South)	46.3%	57.0%	58.9%	63.4%	67.3%	67.7%	70.9%	78.6%	80.8%
Gaul Road (West)	0.0%	0.0%	0.0%	0.0%	0.0%	0.0%	0.0%	0.0%	0.0%
<i>Junction 8 – B1101 Elm Road/Twenty Foot Road</i>									
Twenty Foot Road	15.7%	19.6%	18.9%	20.8%	19.0%	18.9%	24.2%	21.2%	21.2%
B1101 Elm Road (East)	6.0%	7.6%	7.5%	8.3%	8.0%	8.1%	9.1%	9.0%	9.1%
B1101 Elm Road (South)	62.9%	94.5%	91.7%	102.2%	98.4%	99.1%	109.6%	107.4%	106.2%

Figure H.1 – Locations of Congestion Hot Spots (2010 Base, AM)



Figure H.2 – Locations of Congestion Hot Spots (Forecast Year DM Scenarios, AM)

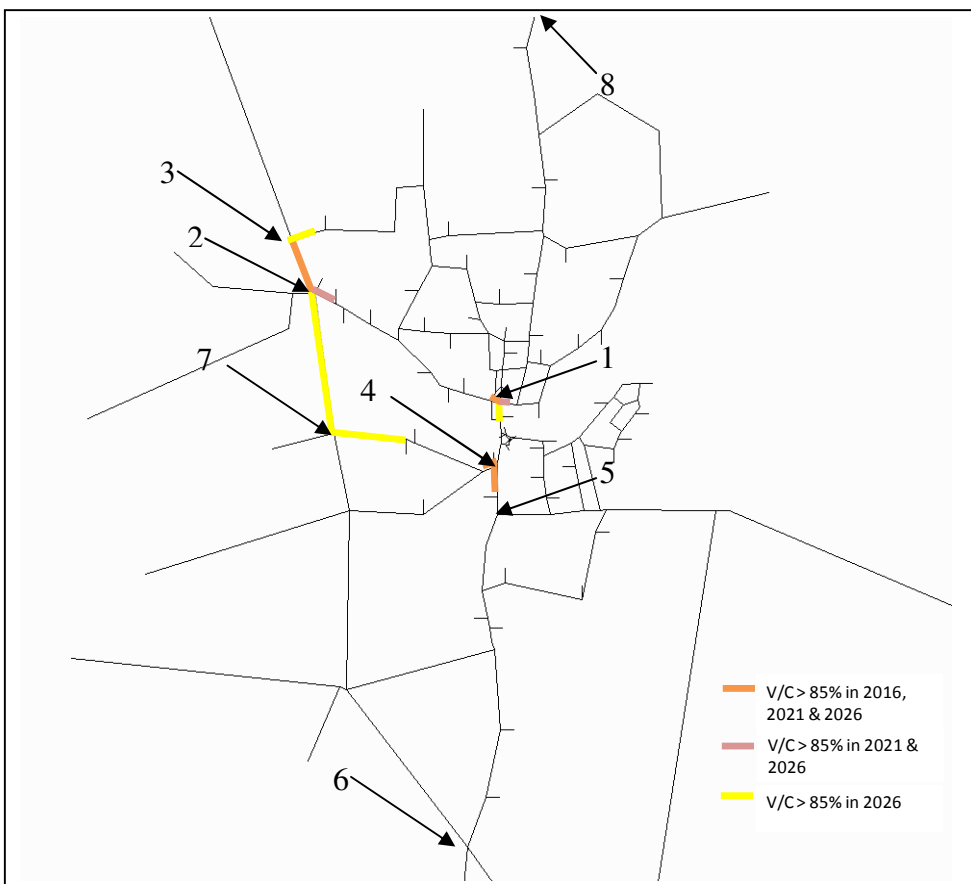

Figure H.3 – Locations of Congestion Hot Spots (Forecast Year DS1 Scenarios, AM)

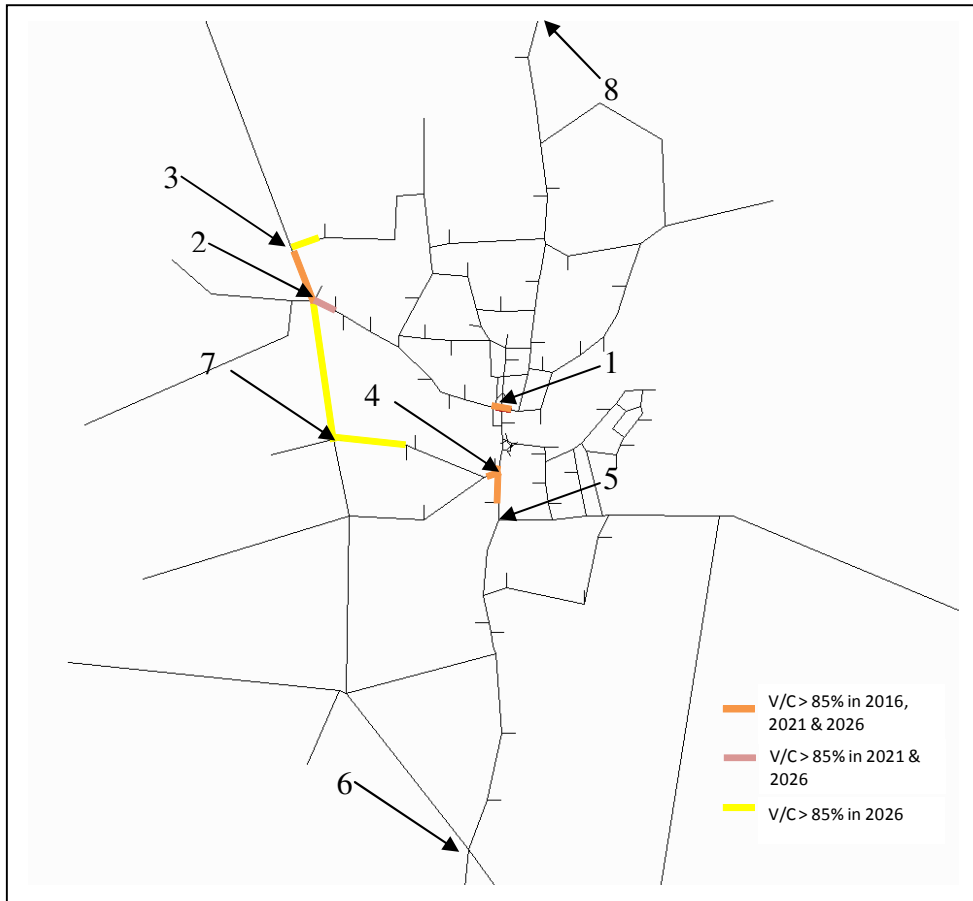

Figure H.4 – Locations of Congestion Hot Spots (Forecast Year DS2 Scenarios, AM)

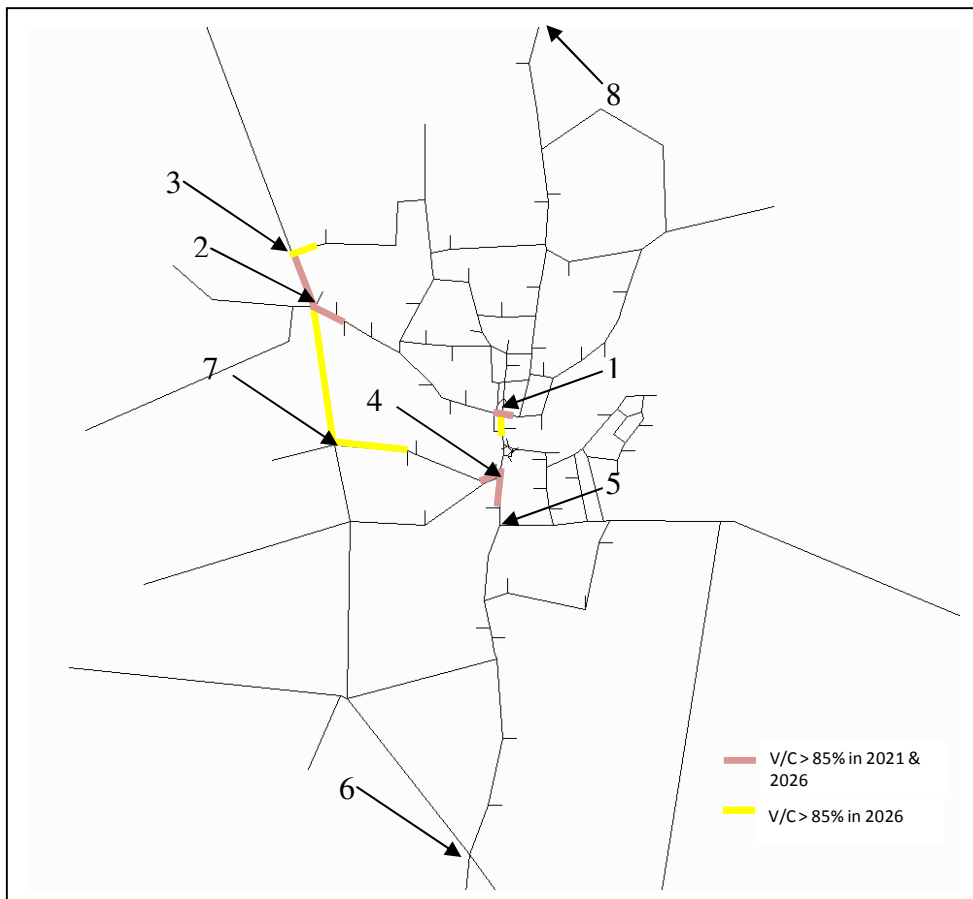

Figure H.5 – Locations of Congestion Hot Spots (2010 Base, IP)

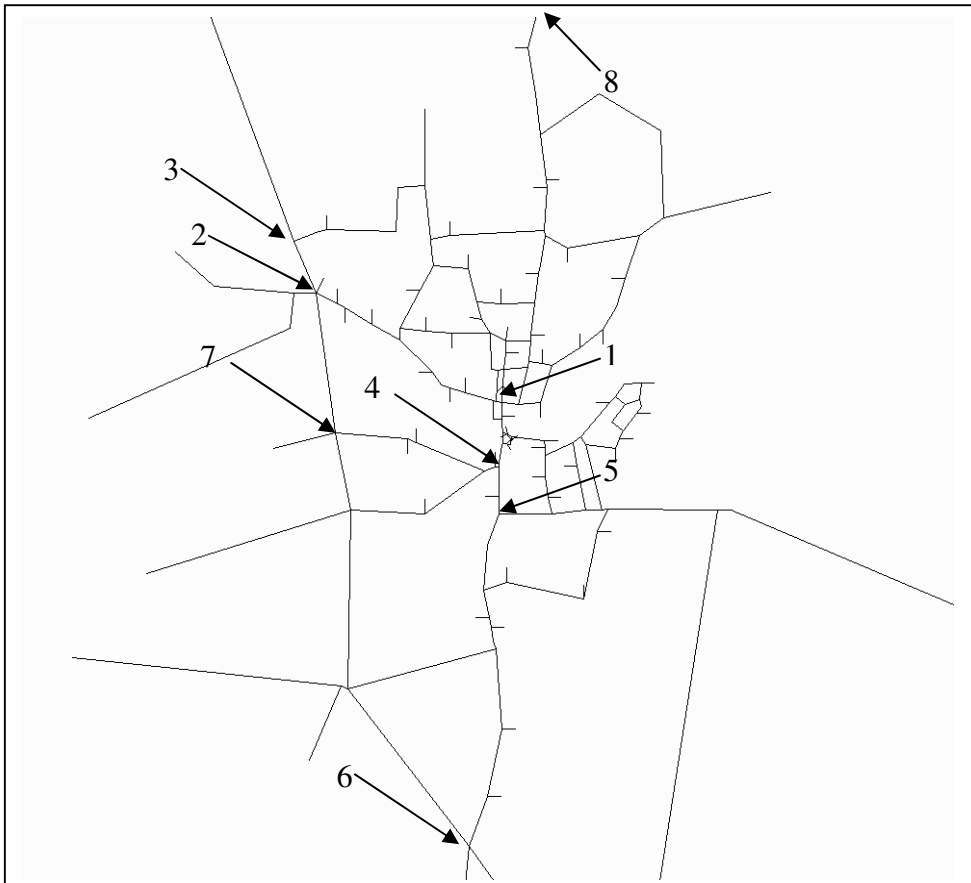

Figure H.6 – Locations of Congestion Hot Spots (Forecast Year DM Scenarios, IP)

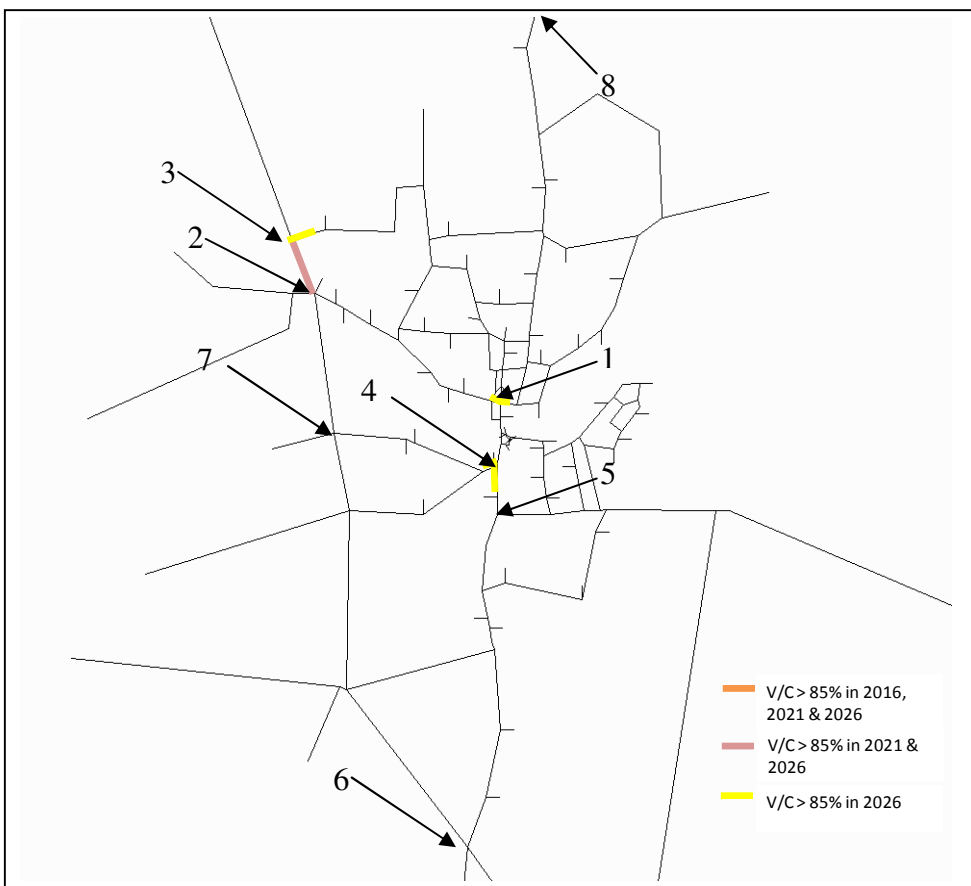

Figure H.7 – Locations of Congestion Hot Spots (Forecast Year DS1 Scenarios, IP)

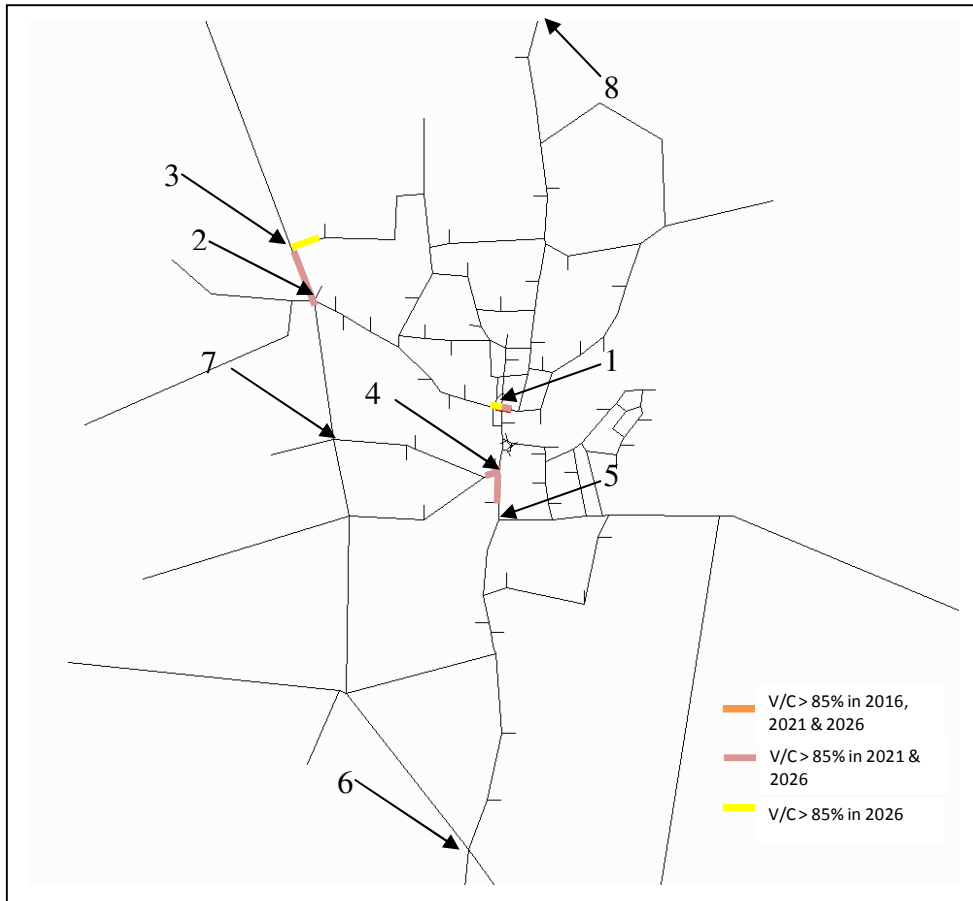

Figure H.8 – Locations of Congestion Hot Spots (Forecast Year DS2 Scenarios, IP)

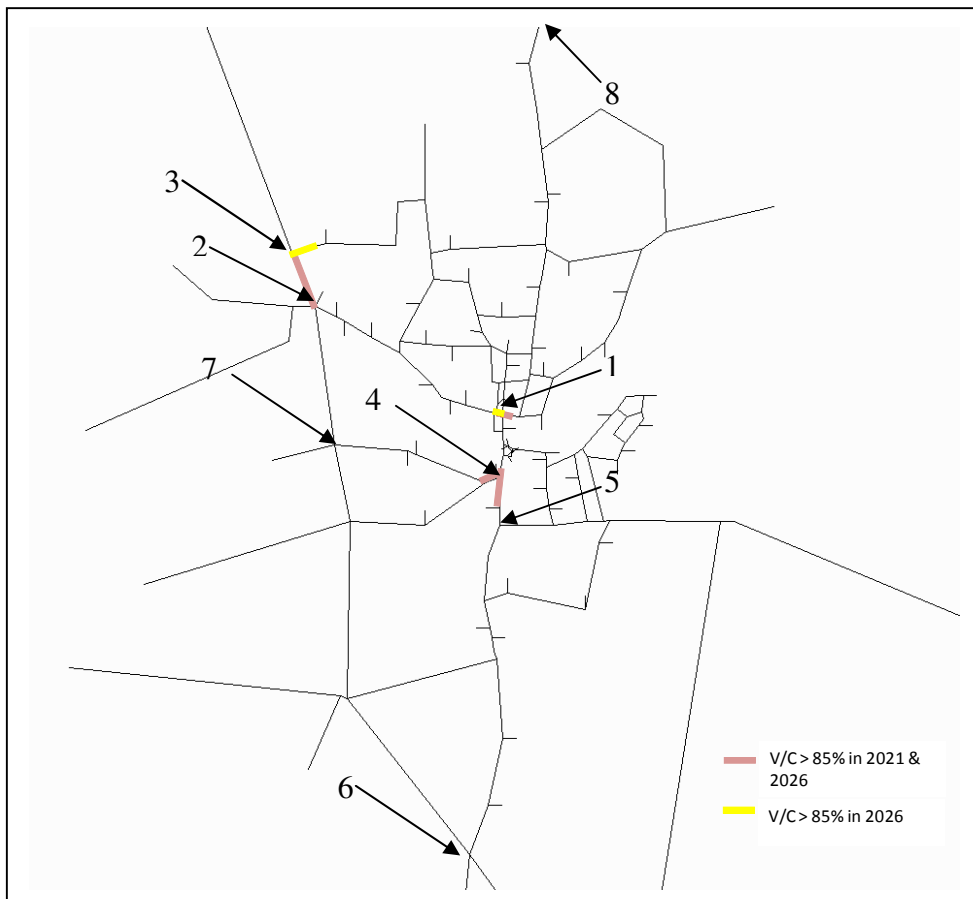

Figure H.9 – Locations of Congestion Hot Spots (2010 Base, PM)



Figure H.10 – Locations of Congestion Hot Spots (Forecast Year DM Scenarios, PM)

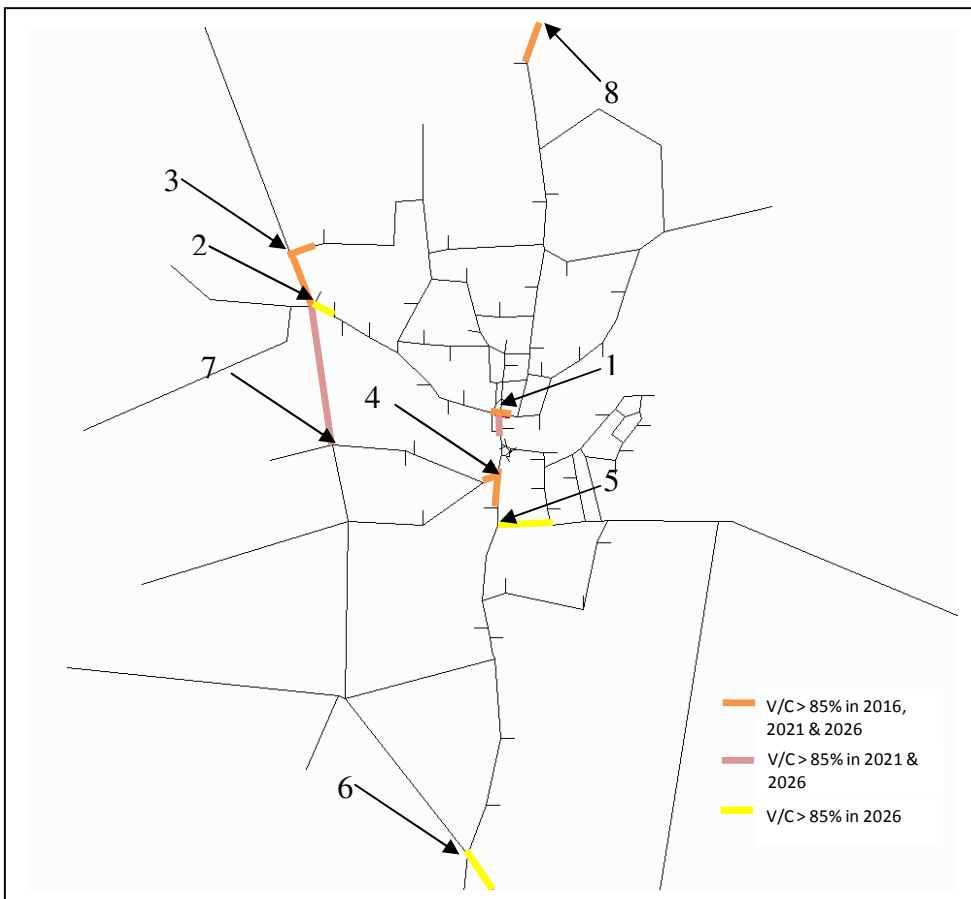

Figure H.11 – Locations of Congestion Hot Spots (Forecast Year DS1 Scenarios, PM)

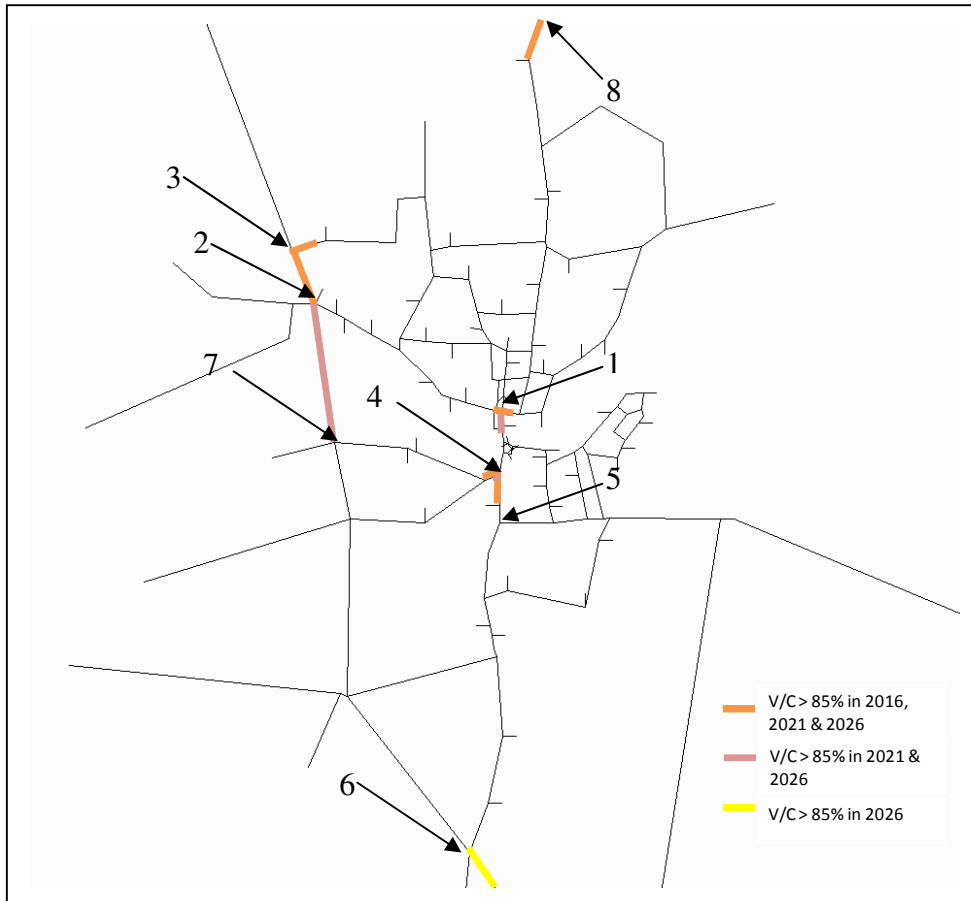

Figure H.12 – Locations of Congestion Hot Spots (Forecast Year DS2 Scenarios, PM)

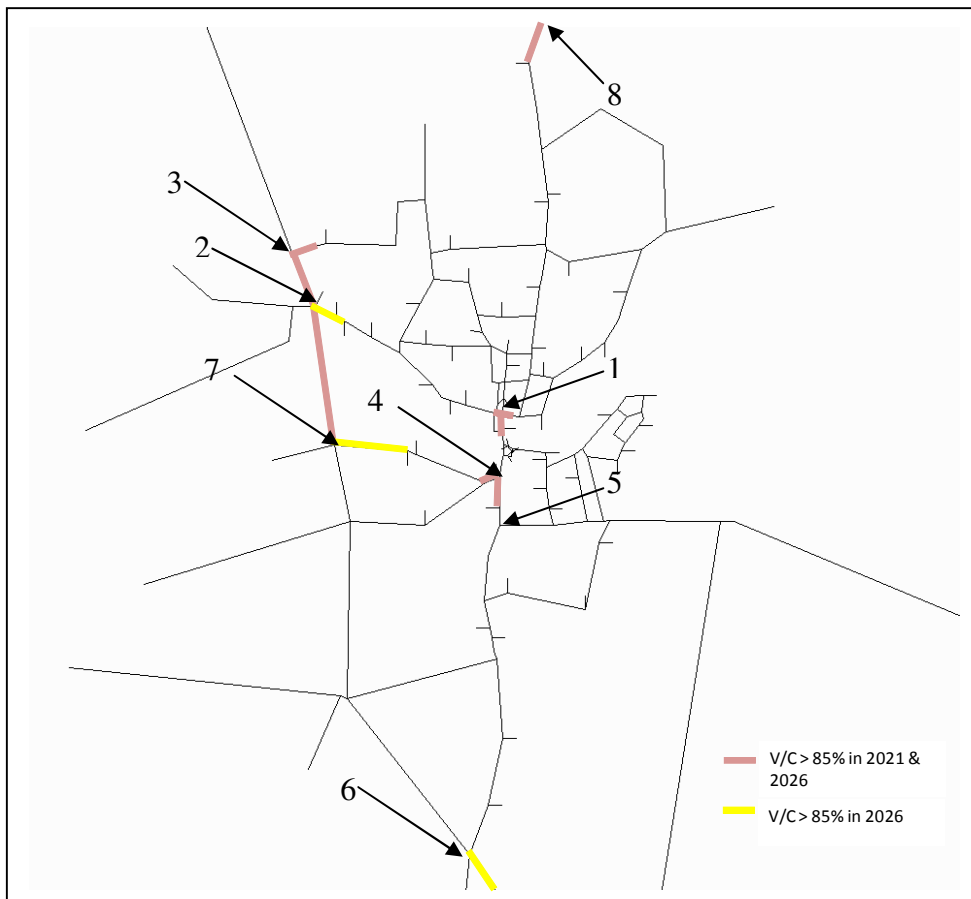

Table H.4 – Junction V/C

Description	2010 Base	2016 DM	2016 DS1	2021 DM	2021 DS1	2021 DS2	2026 DM	2026 DS1	2026 DS2
AM									
B1101 Station Road/B1101 Broad Street/B1099 Dartford Road	73.7%	81.6%	84.7%	84.2%	90.4%	90.5%	89.7%	93.5%	94.9%
A141/B1099 Wisbech Road	44.8%	59.5%	58.3%	67.2%	65.3%	65.6%	73.3%	73.8%	75.5%
A141/Hostmoor Avenue	63.9%	77.8%	77.4%	83.5%	83.2%	83.2%	87.6%	86.6%	86.2%
A141/Burrowmoor Road	40.4%	49.1%	51.6%	55.2%	62.5%	62.8%	61.7%	74.4%	77.9%
A141/Gaul Road	40.8%	49.9%	52.1%	55.9%	61.4%	61.6%	61.3%	72.6%	75.7%
B1101 High Street/Burrowmoor Road	68.5%	88.1%	91.8%	91.5%	99.9%	99.9%	94.0%	101.7%	102.4%
IP									
B1101 Station Road/B1101 Broad Street/B1099 Dartford Road	64.0%	71.9%	71.6%	76.9%	79.0%	79.6%	83.1%	88.0%	89.2%
A141/B1099 Wisbech Road	36.2%	45.6%	45.1%	51.5%	49.7%	49.7%	58.2%	57.8%	59.3%
A141/Hostmoor Avenue	58.2%	69.5%	69.3%	75.7%	75.0%	75.0%	81.2%	81.5%	81.6%
A141/Burrowmoor Road	28.8%	34.1%	35.2%	38.3%	40.3%	40.3%	43.3%	49.0%	51.2%
A141/Gaul Road	30.1%	35.8%	36.8%	39.6%	40.7%	40.9%	43.8%	47.1%	48.9%
B1101 High Street/Burrowmoor Road	56.7%	67.6%	70.6%	77.7%	90.3%	90.9%	89.0%	96.9%	100.3%
PM									
B1101 Station Road/B1101 Broad Street/B1099 Dartford Road	80.8%	87.9%	87.9%	91.1%	93.0%	93.6%	93.8%	93.8%	94.3%
A141/B1099 Wisbech Road	51.5%	64.7%	63.2%	70.9%	67.8%	68.6%	81.1%	79.6%	82.3%
A141/Hostmoor Avenue	70.3%	84.7%	85.0%	87.9%	88.1%	88.0%	91.1%	90.8%	90.6%
A141/Burrowmoor Road	42.5%	52.6%	54.1%	59.0%	62.8%	63.1%	66.8%	73.5%	77.7%
A141/Gaul Road	43.6%	54.2%	54.6%	61.2%	61.6%	62.1%	68.3%	73.2%	76.9%
B1101 High Street/Burrowmoor Road	76.5%	93.0%	90.0%	98.4%	99.2%	99.0%	100.9%	101.9%	102.8%

Table H.5 – Junction Delay (per veh in seconds) (2016)

Description	2010 Base	2016 DM	DM - Base	2016 DS1	DS1 - DM *
AM					
B1101 Station Road/B1101 Broad Street/B1099 Dartford Road	44	50	6	60	10
A141/B1099 Wisbech Road	17	20	3	19	0
A141/Hostmoor Avenue	7	13	6	12	-1
A141/Burrowmoor Road	4	6	2	7	1
A141/Gaul Road	4	5	1	4	-1
B1101 High Street/Burrowmoor Road	10	18	8	19	1
IP					
B1101 Station Road/B1101 Broad Street/B1099 Dartford Road	46	48	2	50	2
A141/B1099 Wisbech Road	17	18	1	18	0
A141/Hostmoor Avenue	6	8	3	8	0
A141/Burrowmoor Road	3	4	1	4	0
A141/Gaul Road	4	5	1	5	0
B1101 High Street/Burrowmoor Road	9	10	1	10	1
PM					
B1101 Station Road/B1101 Broad Street/B1099 Dartford Road	58	69	11	68	-1
A141/B1099 Wisbech Road	18	22	3	21	0
A141/Hostmoor Avenue	9	65	57	72	6
A141/Burrowmoor Road	4	5	1	7	2
A141/Gaul Road	4	4	0	4	0
B1101 High Street/Burrowmoor Road	12	22	10	21	-1

* Absolute Difference > +30s = highlighted in **bold**

Table H.6 – Junction Delay (per veh in seconds) (2021)

Description	2010 Base	2021 DM	DM - Base	2021 DS1	DS1 - DM *	2021 DS2	DS2 - DS1 *	DS2 - DM *
AM								
B1101 Station Road/B1101 Broad Street/B1099 Dartford Road	44	55	11	77	22	77	0	22
A141/B1099 Wisbech Road	17	22	5	22	0	22	0	0
A141/Hostmoor Avenue	7	21	14	18	-2	18	0	-2
A141/Burrowmoor Road	4	7	3	10	3	10	0	3
A141/Gaul Road	4	6	2	8	2	8	0	2
B1101 High Street/Burrowmoor Road	10	24	14	35	11	35	0	11
IP								
B1101 Station Road/B1101 Broad Street/B1099 Dartford Road	46	52	6	59	7	62	2	9
A141/B1099 Wisbech Road	17	19	2	18	0	18	0	0
A141/Hostmoor Avenue	6	11	6	11	0	11	0	0
A141/Burrowmoor Road	3	5	2	6	1	6	0	1
A141/Gaul Road	4	5	1	5	-1	5	0	-1
B1101 High Street/Burrowmoor Road	9	12	3	18	7	19	1	8
PM								
B1101 Station Road/B1101 Broad Street/B1099 Dartford Road	58	78	20	87	9	94	7	16
A141/B1099 Wisbech Road	18	23	4	22	-1	22	0	0
A141/Hostmoor Avenue	9	101	92	104	3	102	-3	1
A141/Burrowmoor Road	4	5	2	8	3	10	2	4
A141/Gaul Road	4	6	2	5	-1	5	0	-1
B1101 High Street/Burrowmoor Road	12	44	32	42	-2	42	0	-2

* Absolute Difference > +30s = highlighted in **bold**

Table H.7 – Junction Delay (per veh in seconds) (2026)

Description	2010 Base	2026 DM	DM - Base	2026 DS1	DS1 - DM *	2026 DS2	DS2 - DS1 *	DS2 - DM *
AM								
B1101 Station Road/B1101 Broad Street/B1099 Dartford Road	44	69	25	109	40	135	26	66
A141/B1099 Wisbech Road	17	24	8	34	10	36	2	12
A141/Hostmoor Avenue	7	28	21	18	-10	17	-1	-11
A141/Burrowmoor Road	4	9	5	13	3	15	2	6
A141/Gaul Road	4	9	5	12	3	14	2	5
B1101 High Street/Burrowmoor Road	10	36	26	66	30	78	12	42
IP								
B1101 Station Road/B1101 Broad Street/B1099 Dartford Road	46	60	14	70	10	75	6	15
A141/B1099 Wisbech Road	17	20	3	20	0	20	0	0
A141/Hostmoor Avenue	6	18	12	18	0	18	0	0
A141/Burrowmoor Road	3	6	3	9	3	10	1	4
A141/Gaul Road	4	5	1	4	-1	4	0	0
B1101 High Street/Burrowmoor Road	9	19	10	28	9	42	14	23
PM								
B1101 Station Road/B1101 Broad Street/B1099 Dartford Road	58	92	34	105	14	112	7	21
A141/B1099 Wisbech Road	18	30	12	49	19	67	18	37
A141/Hostmoor Avenue	9	134	126	117	-17	109	-8	-25
A141/Burrowmoor Road	4	7	4	9	2	11	1	3
A141/Gaul Road	4	8	4	9	1	11	2	2
B1101 High Street/Burrowmoor Road	12	70	58	85	15	102	16	31

* Absolute Difference > +30s = highlighted in **bold**

Figure H.13 – Junction V/C (2010 Base, AM)

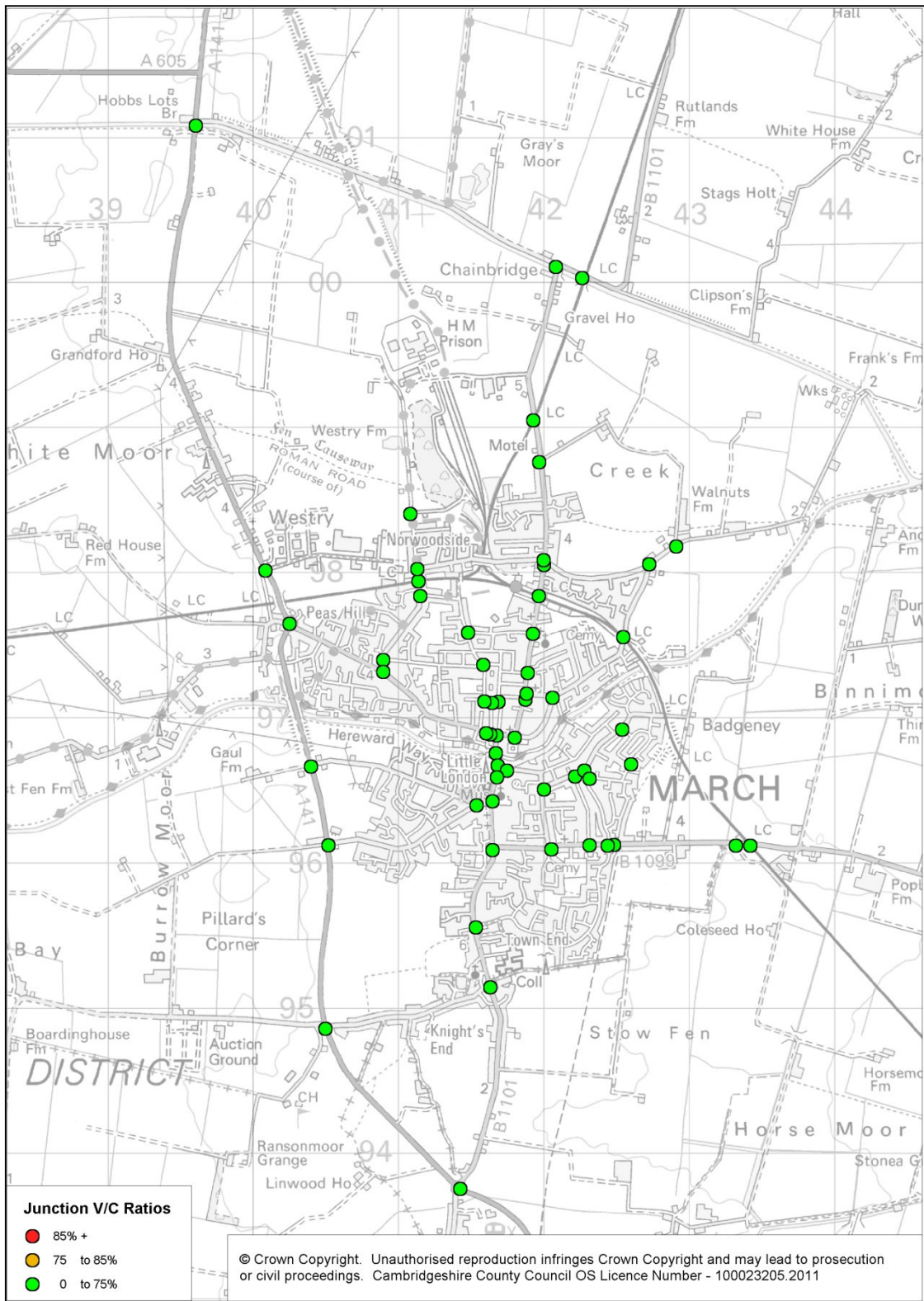

Figure H.14 – Junction V/C (2016 DM, AM)

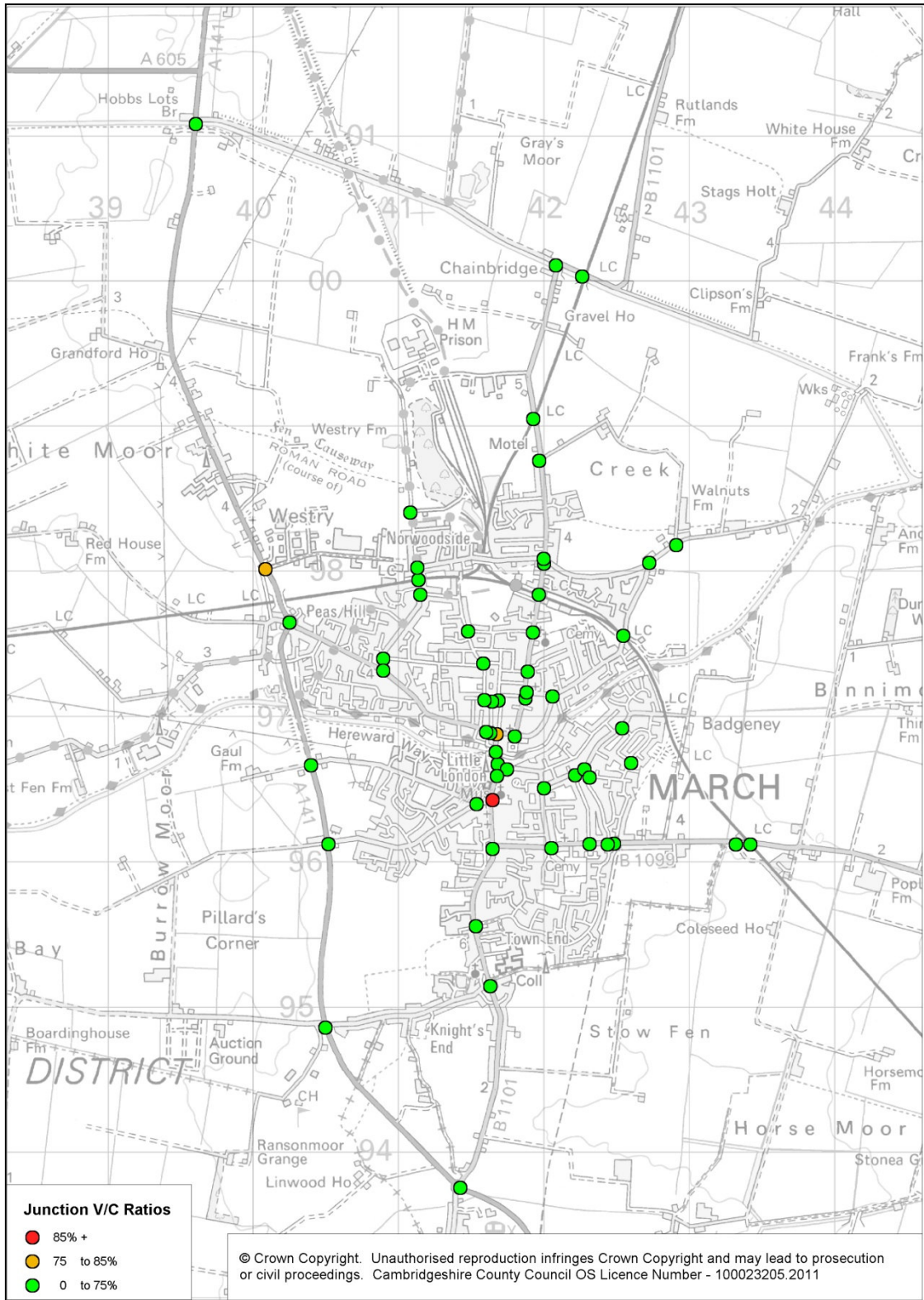

Figure H.15 – Junction V/C (2016 DS1, AM)

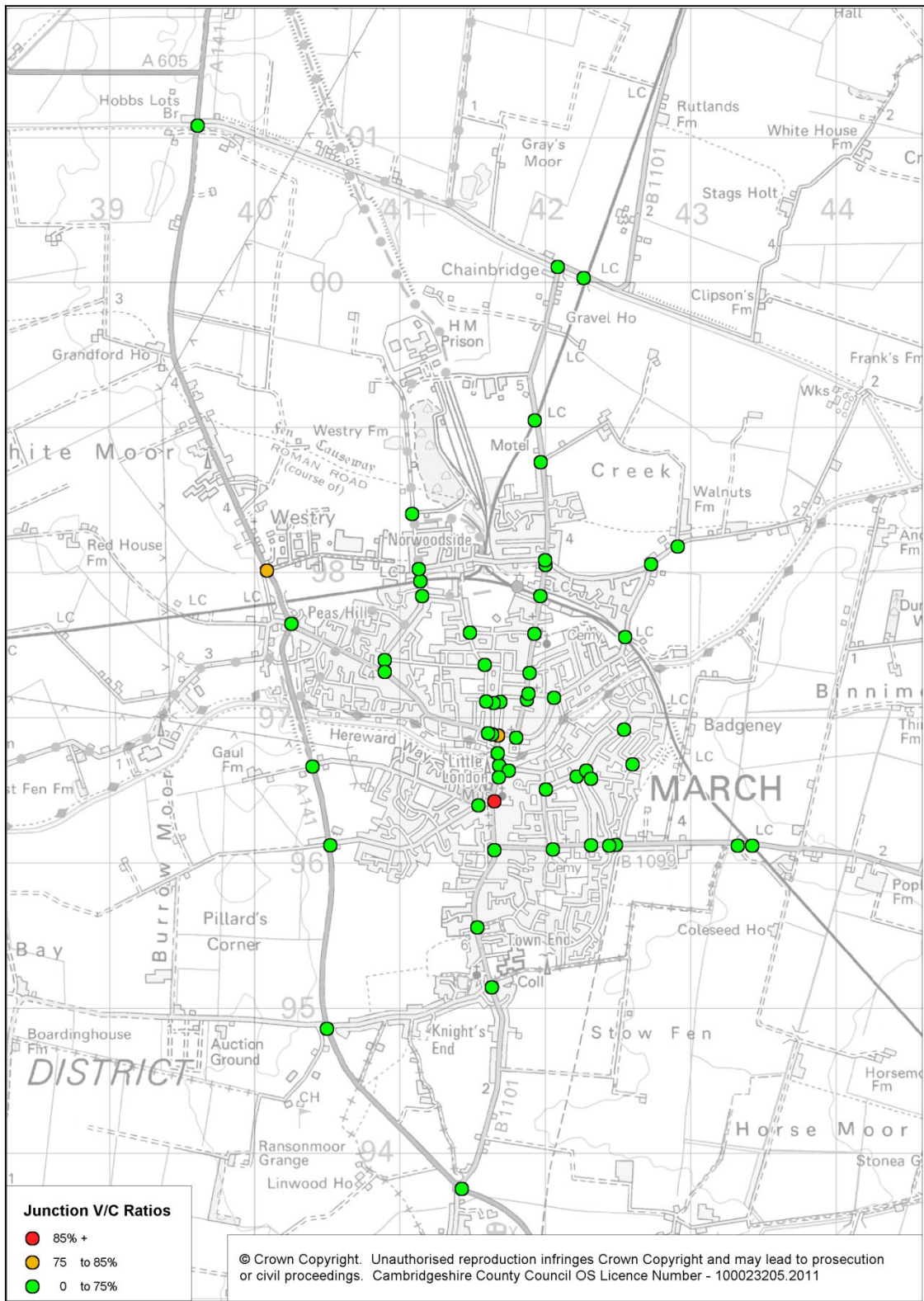

Figure H.16 – Junction V/C (2021 DM, AM)

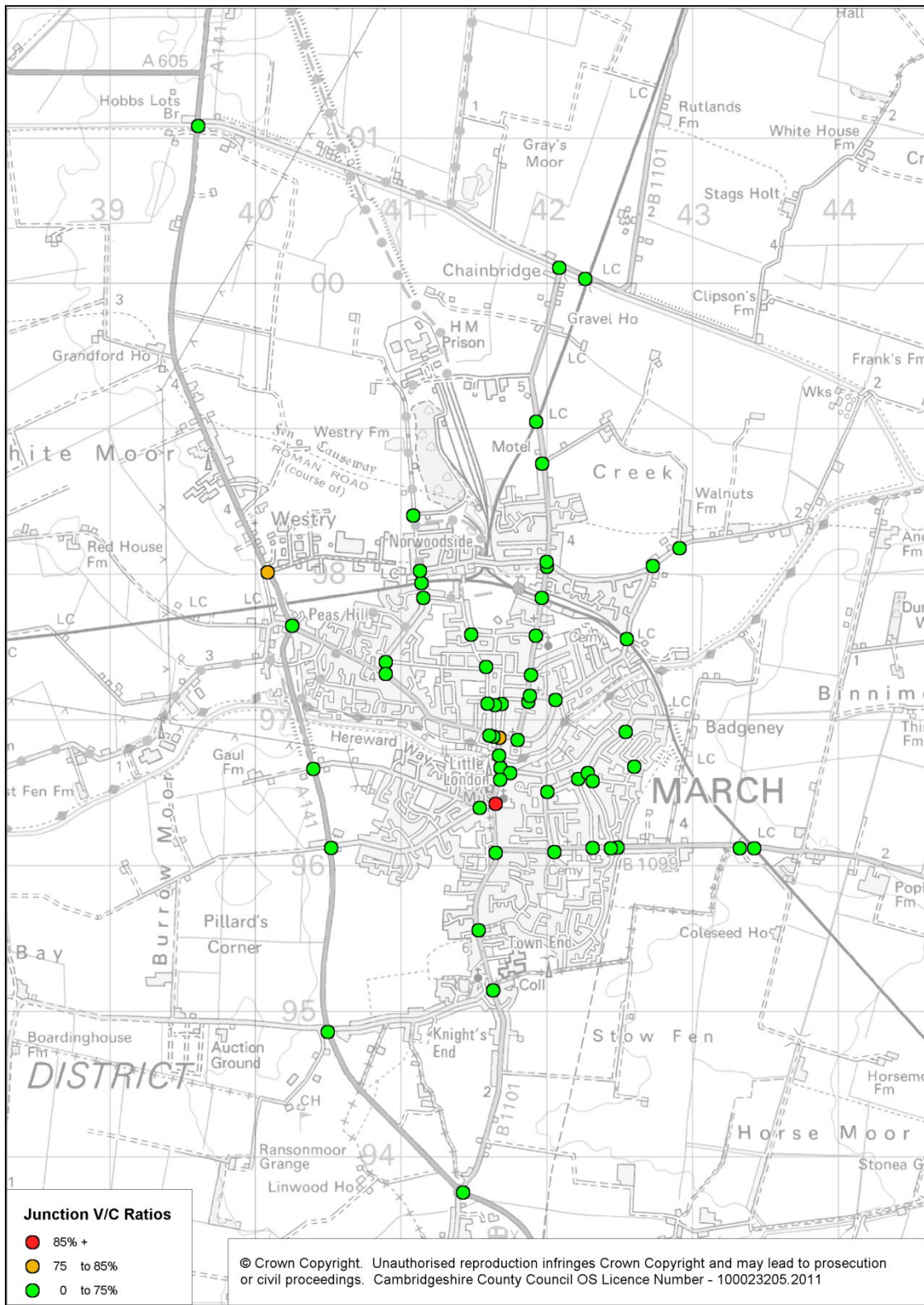

Figure H.17 – Junction V/C (2021 DS1, AM)

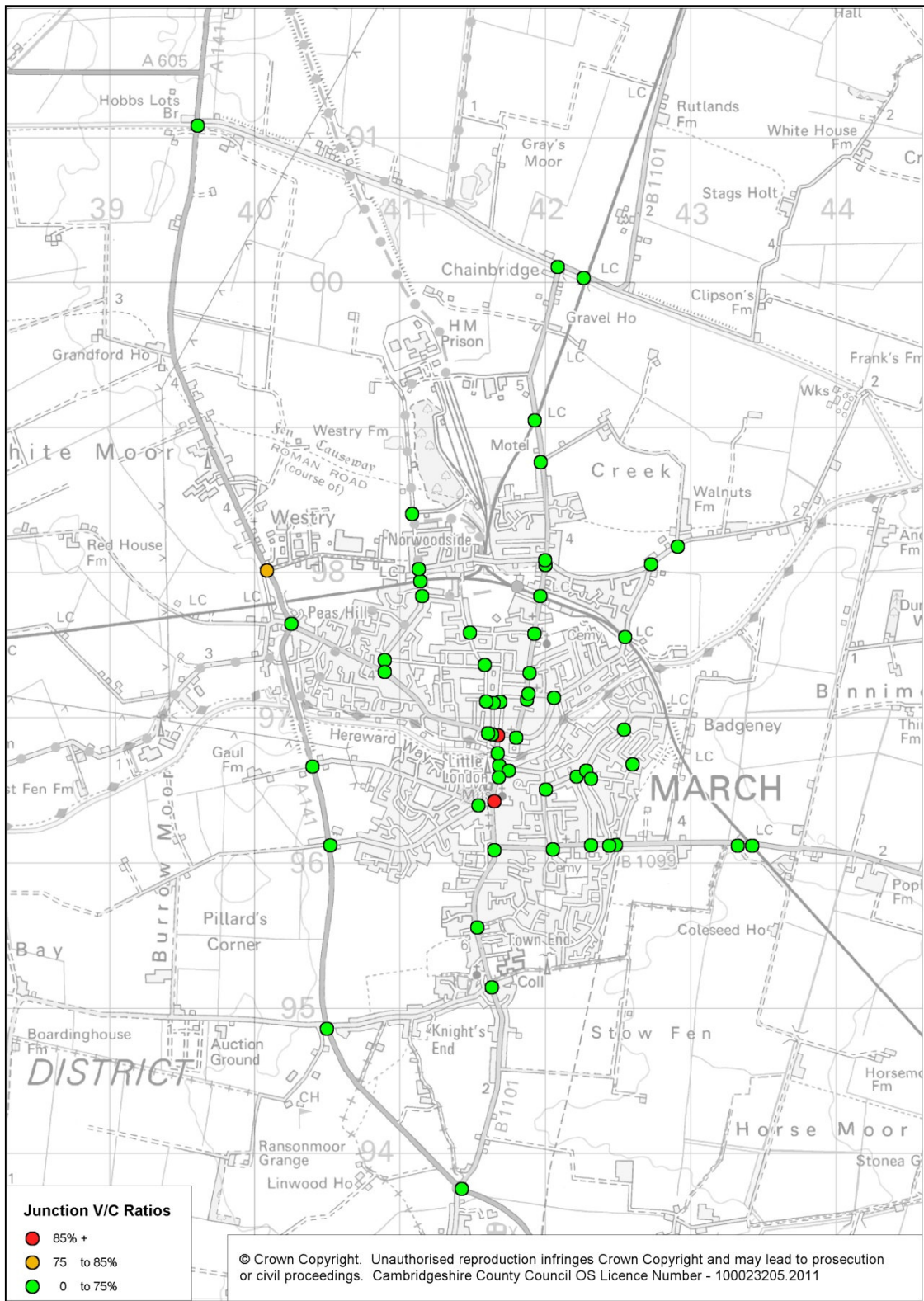

Figure H.18 – Junction V/C (2021 DS2, AM)

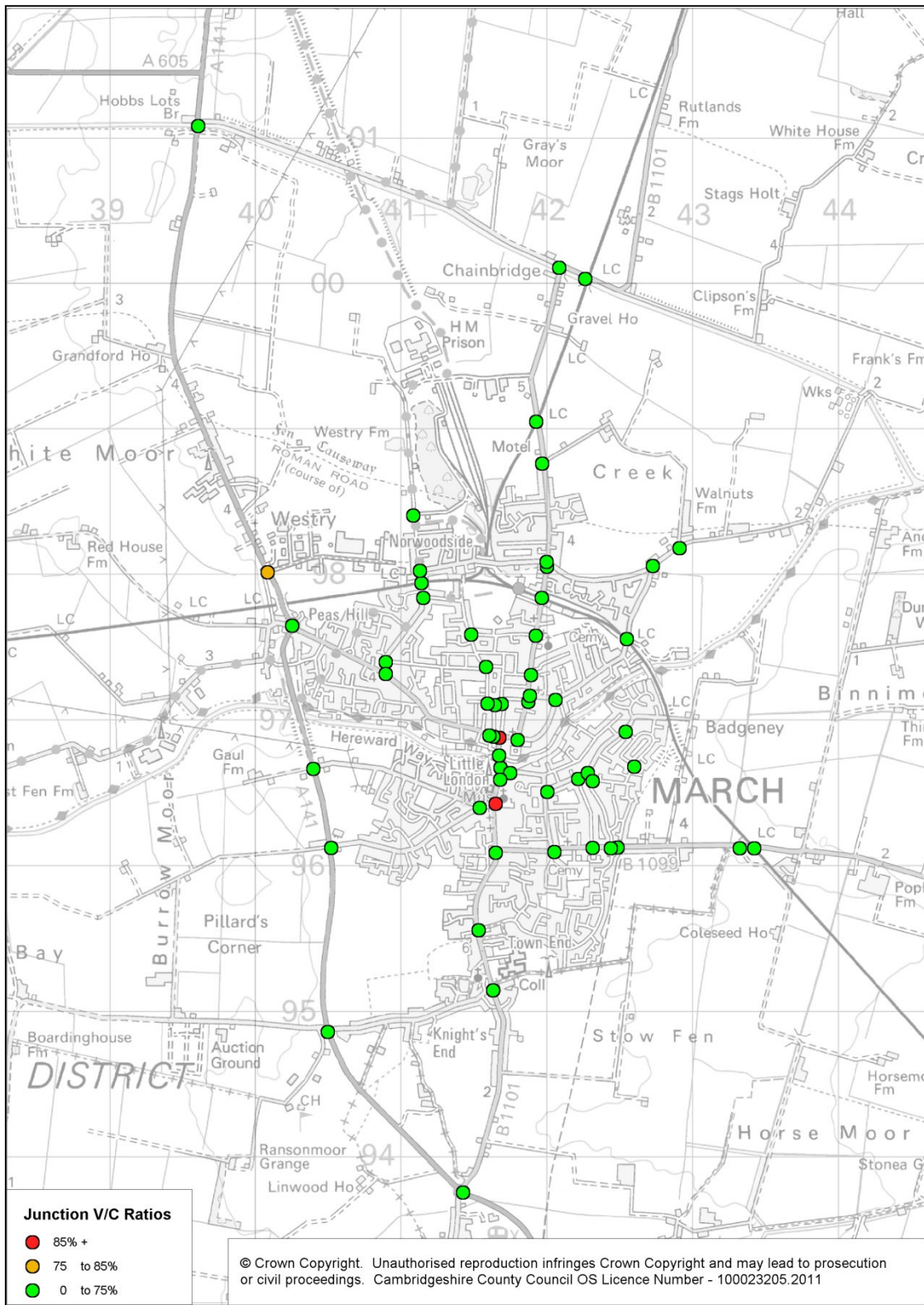

Figure H.19 – Junction V/C (2026 DM, AM)

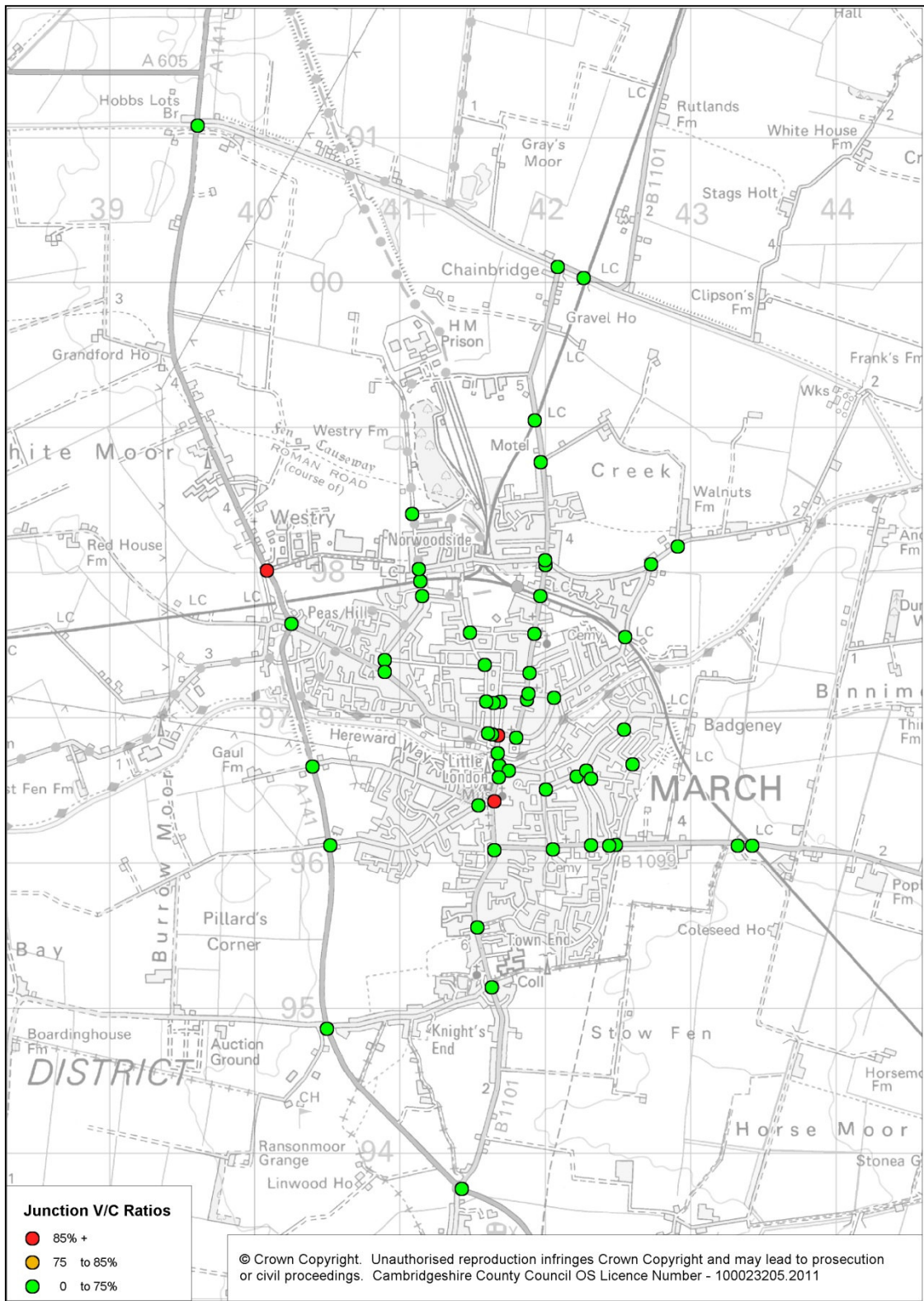

Figure H.20 – Junction V/C (2026 DS1, AM)

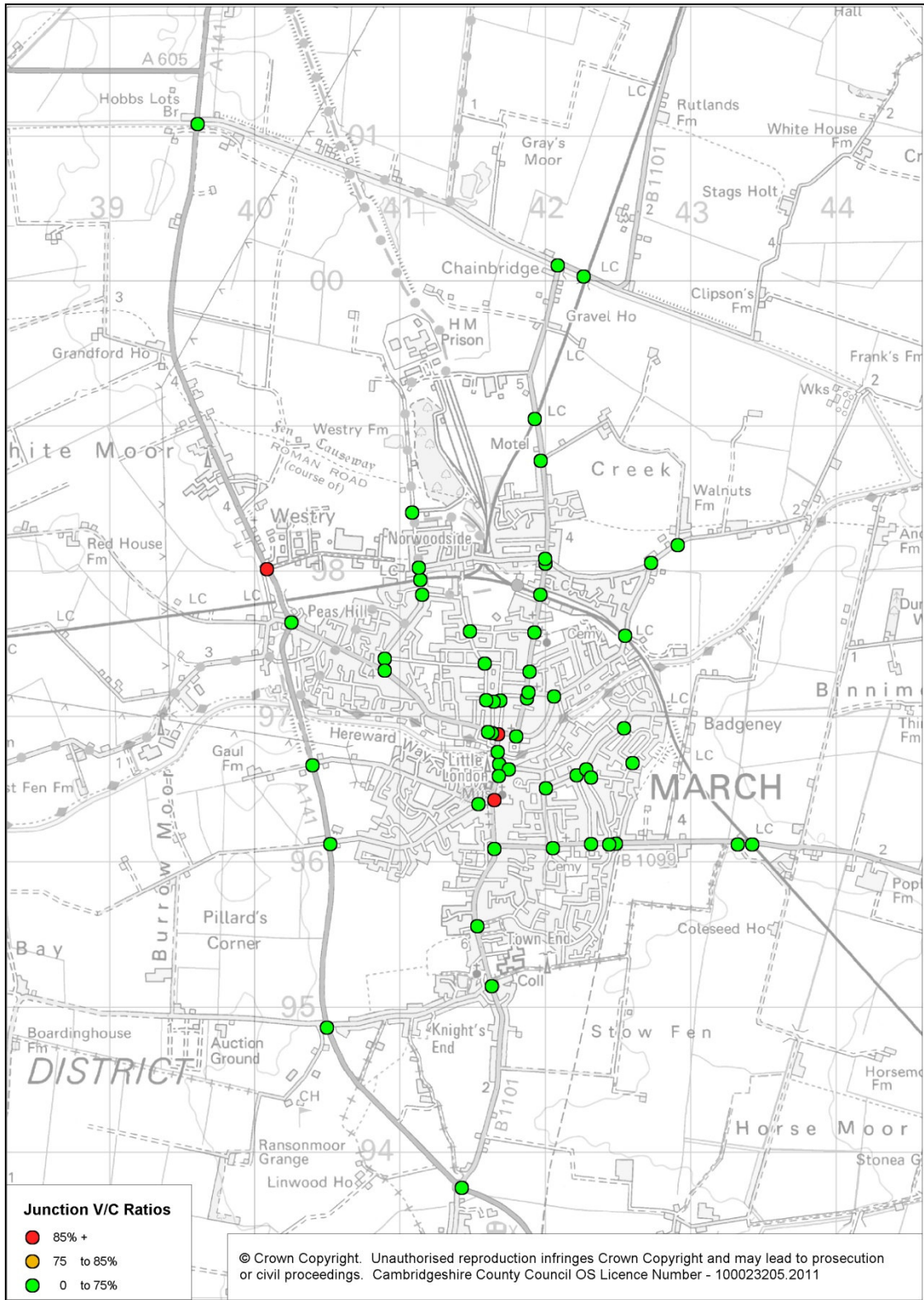

Figure H.21 – Junction V/C (2026 DS2, AM)

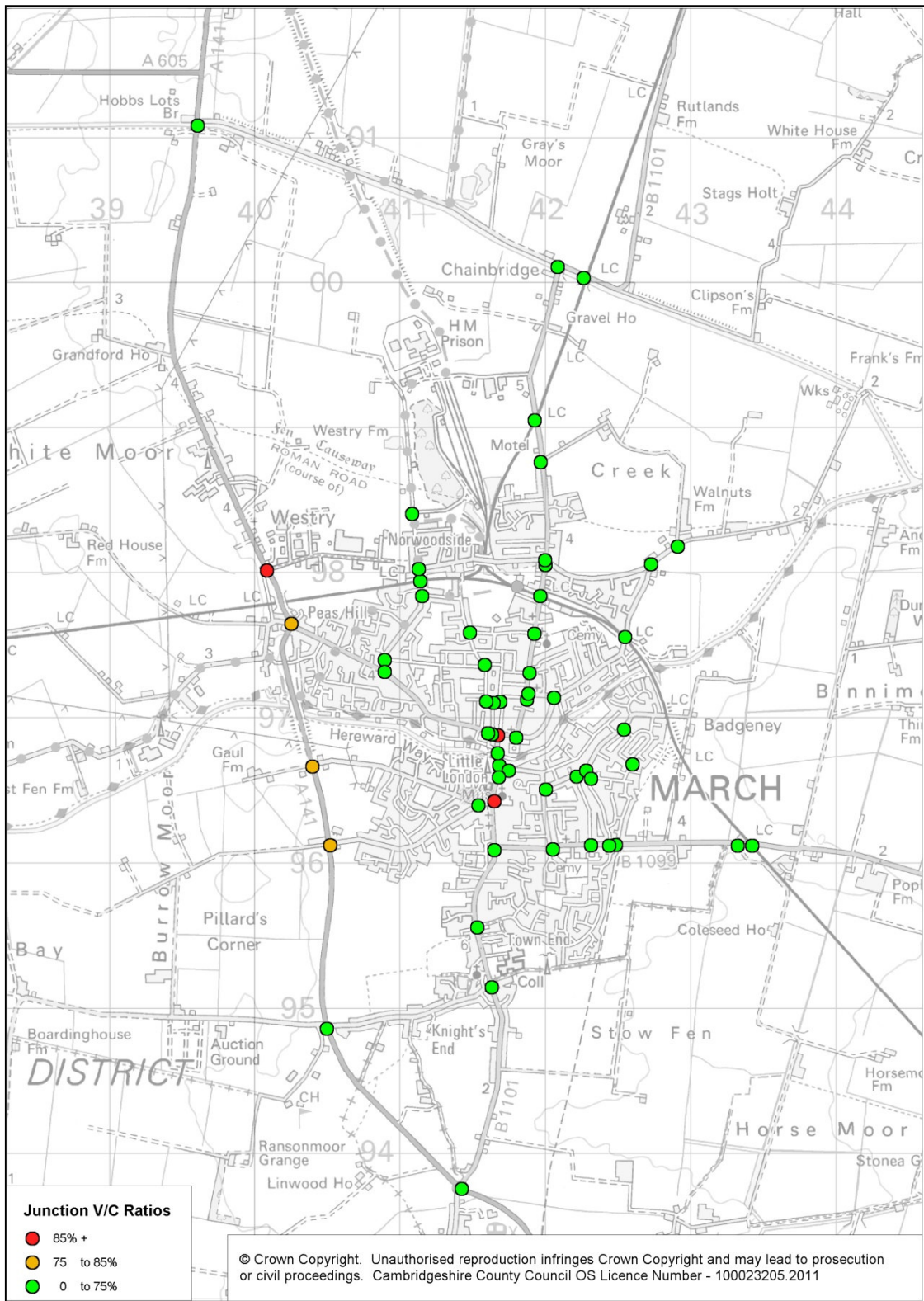

Figure H.22 – Junction V/C (2010 Base, IP)

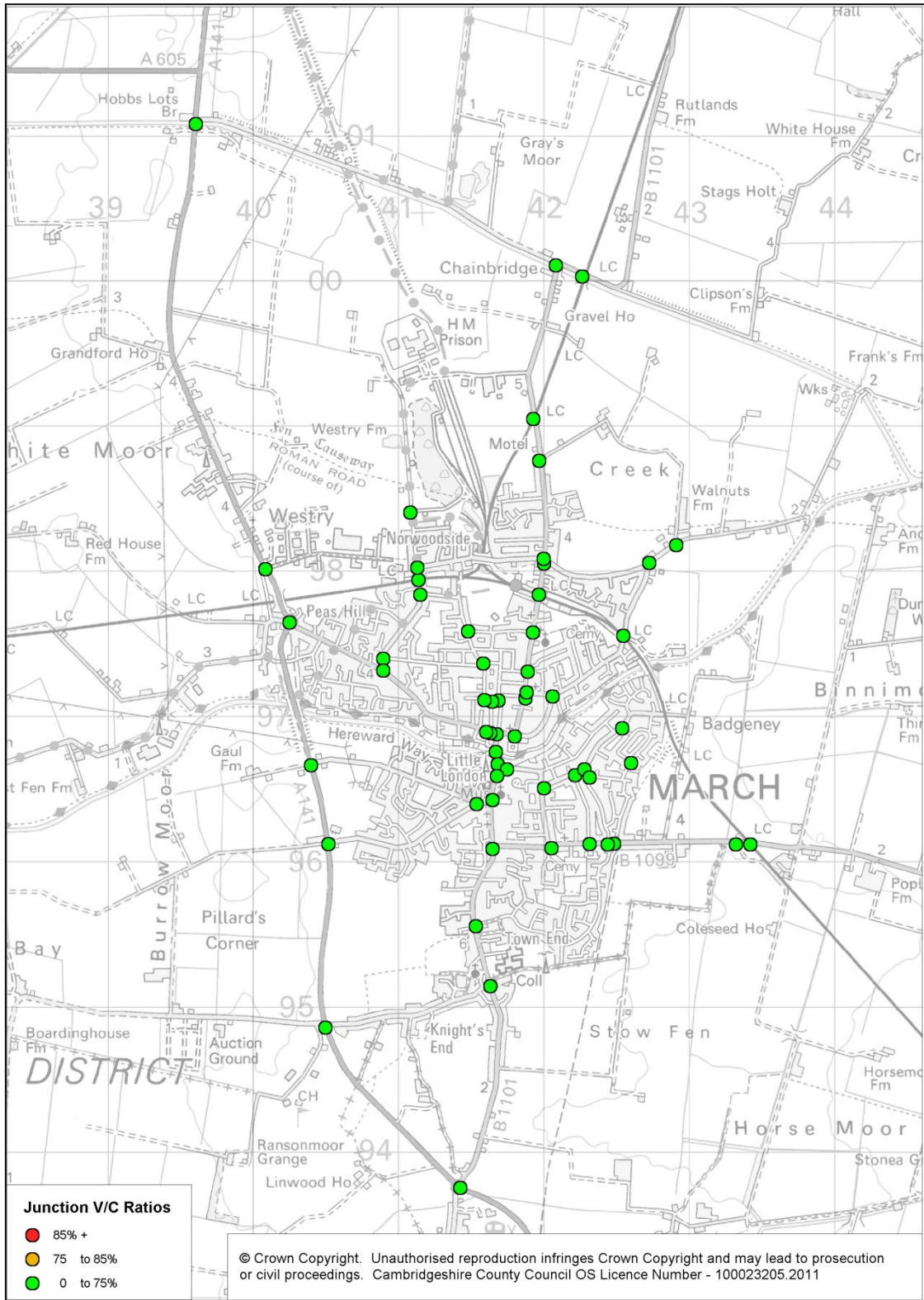

Figure H.23 – Junction V/C (2016 DM, IP)

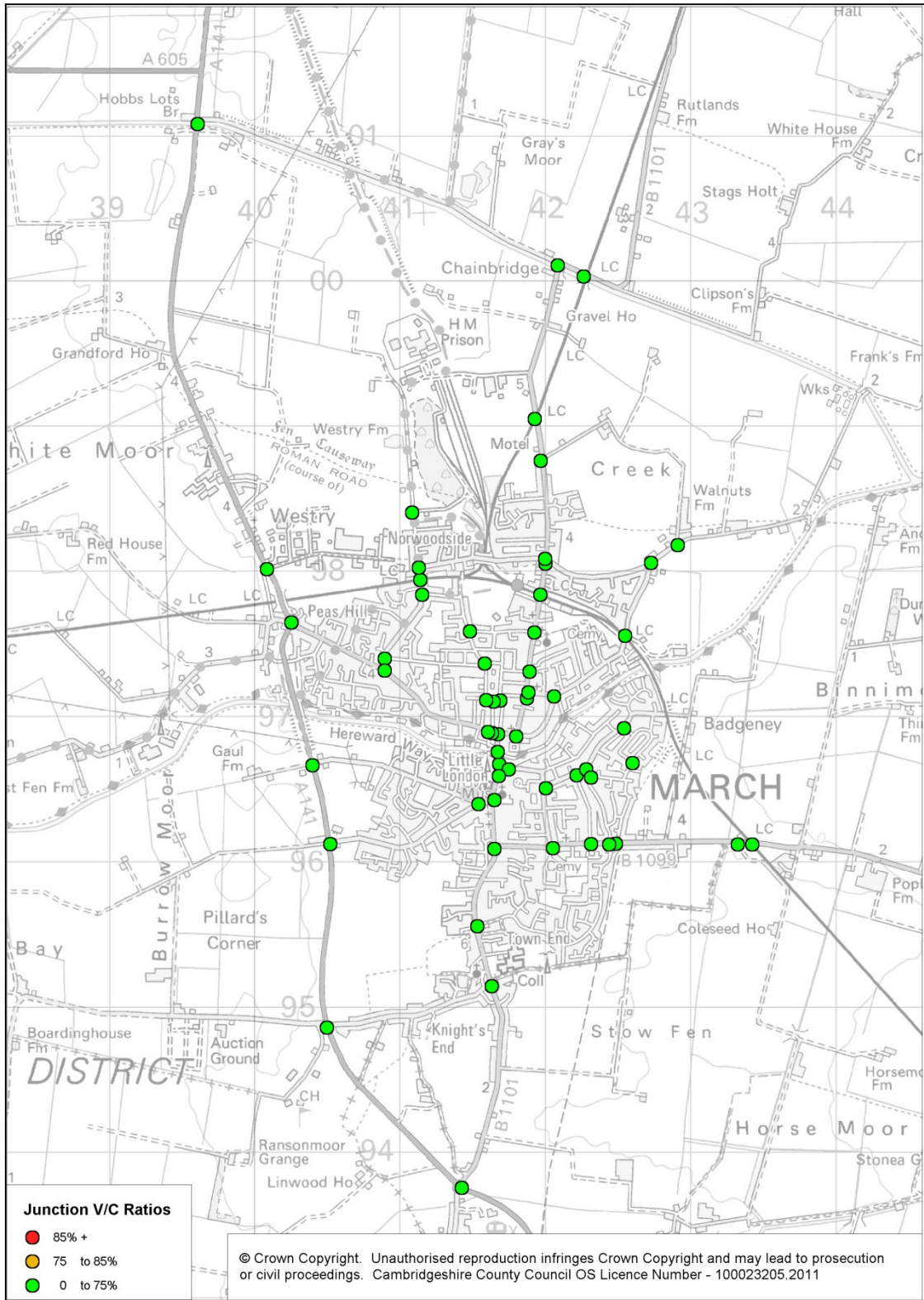

Figure H.24 – Junction V/C (2016 DS1, IP)

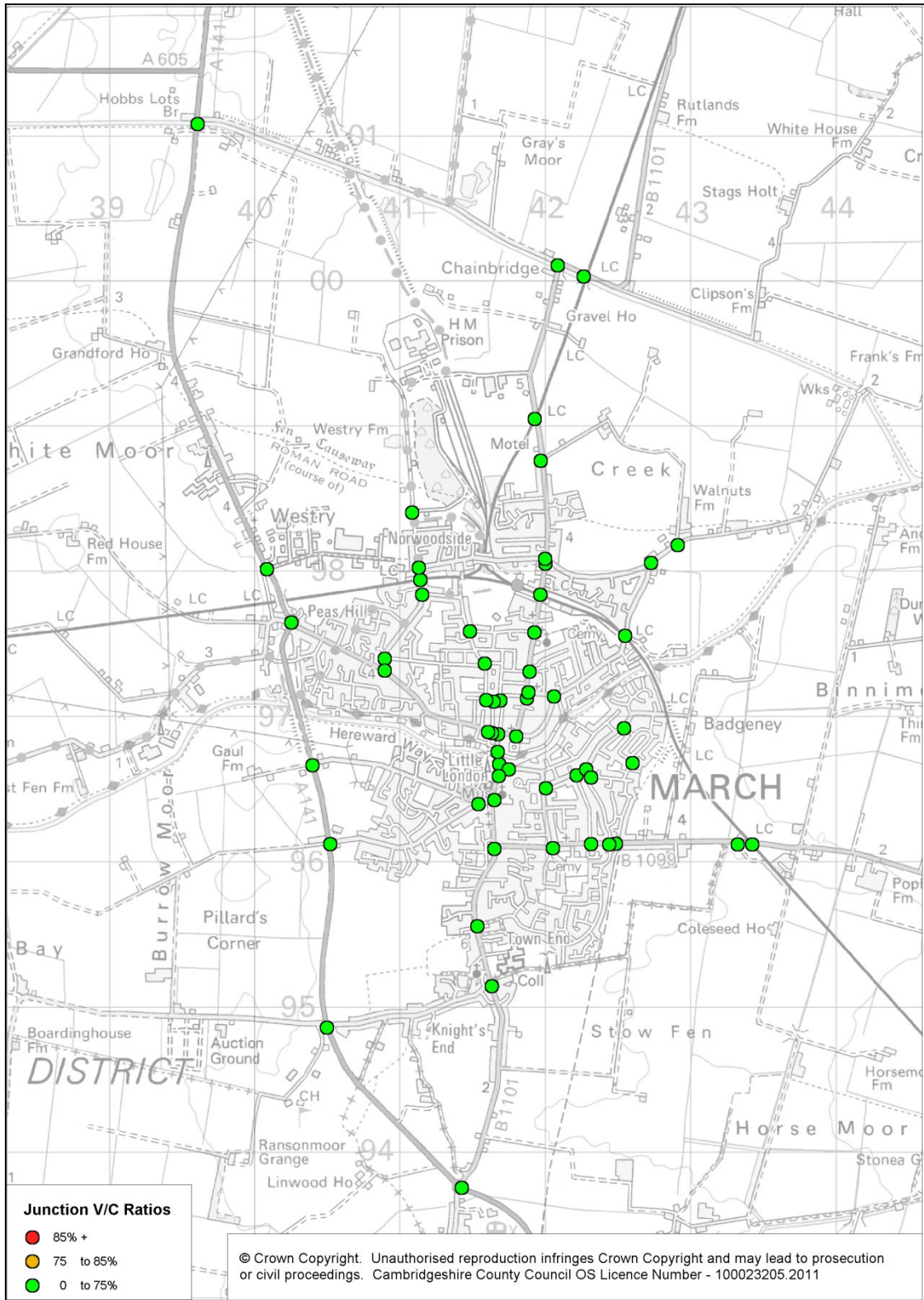

Figure H.25 – Junction V/C (2021 DM, IP)

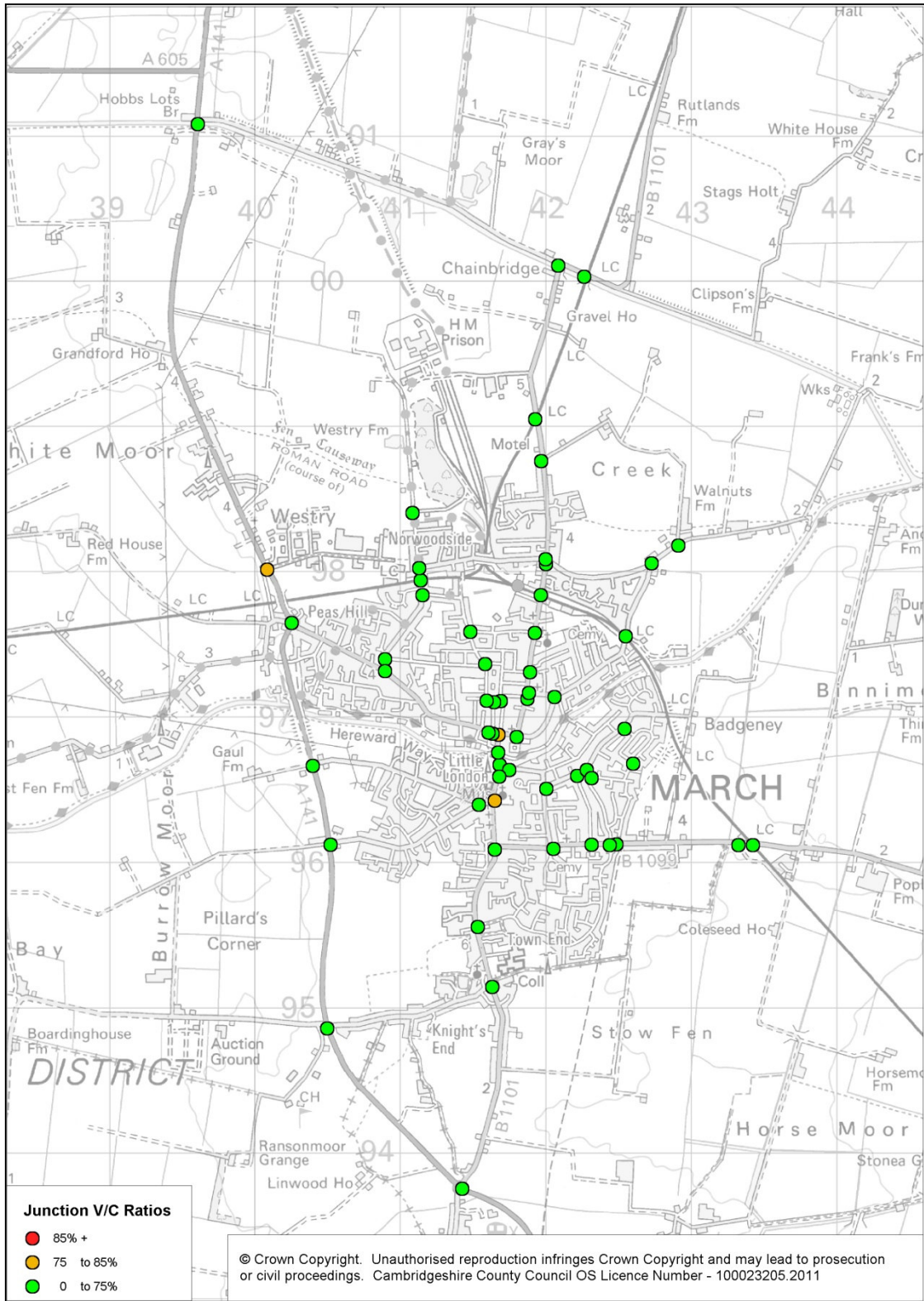

Figure H.26 – Junction V/C (2021 DS1, IP)

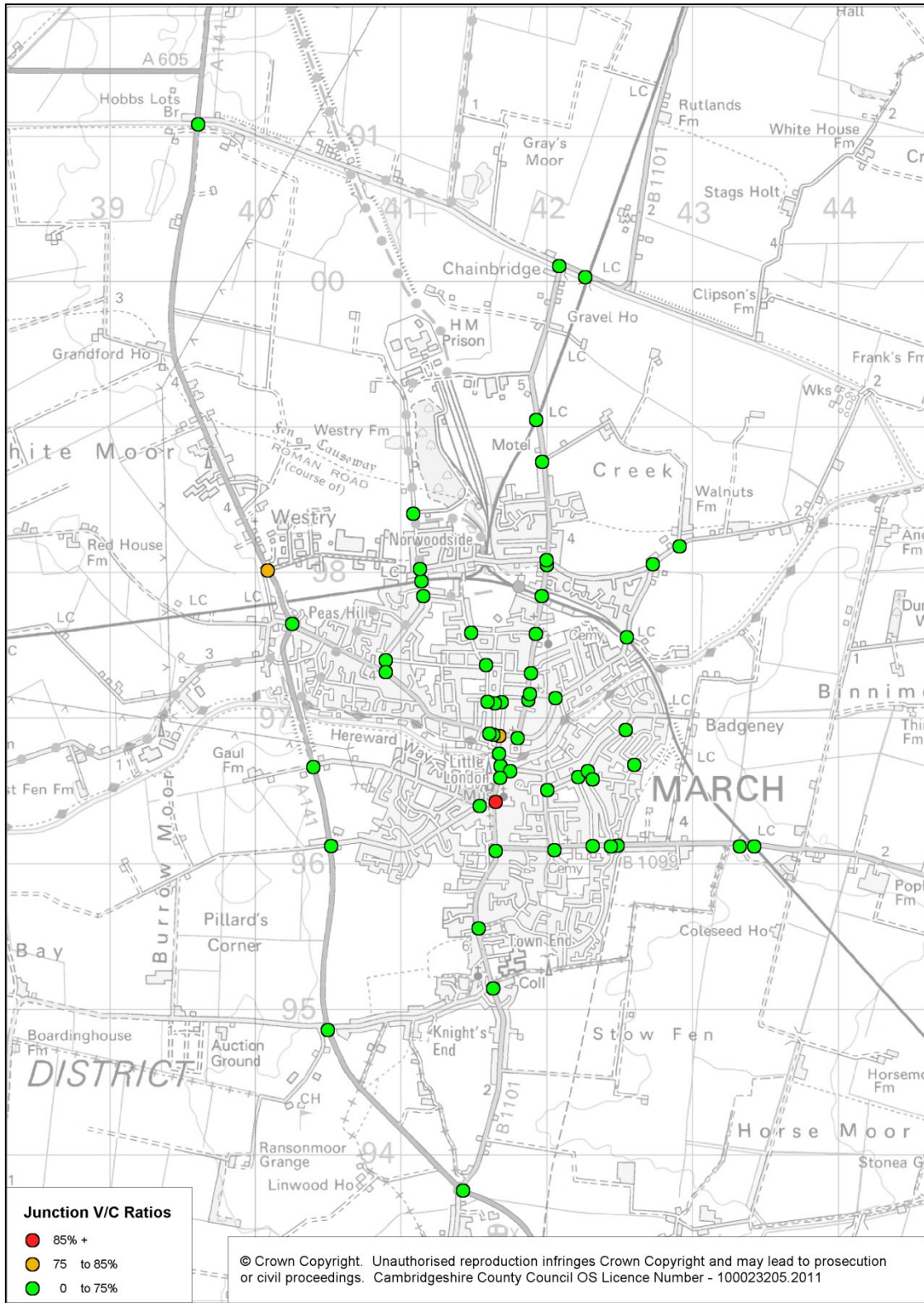

Figure H.27 – Junction V/C (2021 DS2, IP)

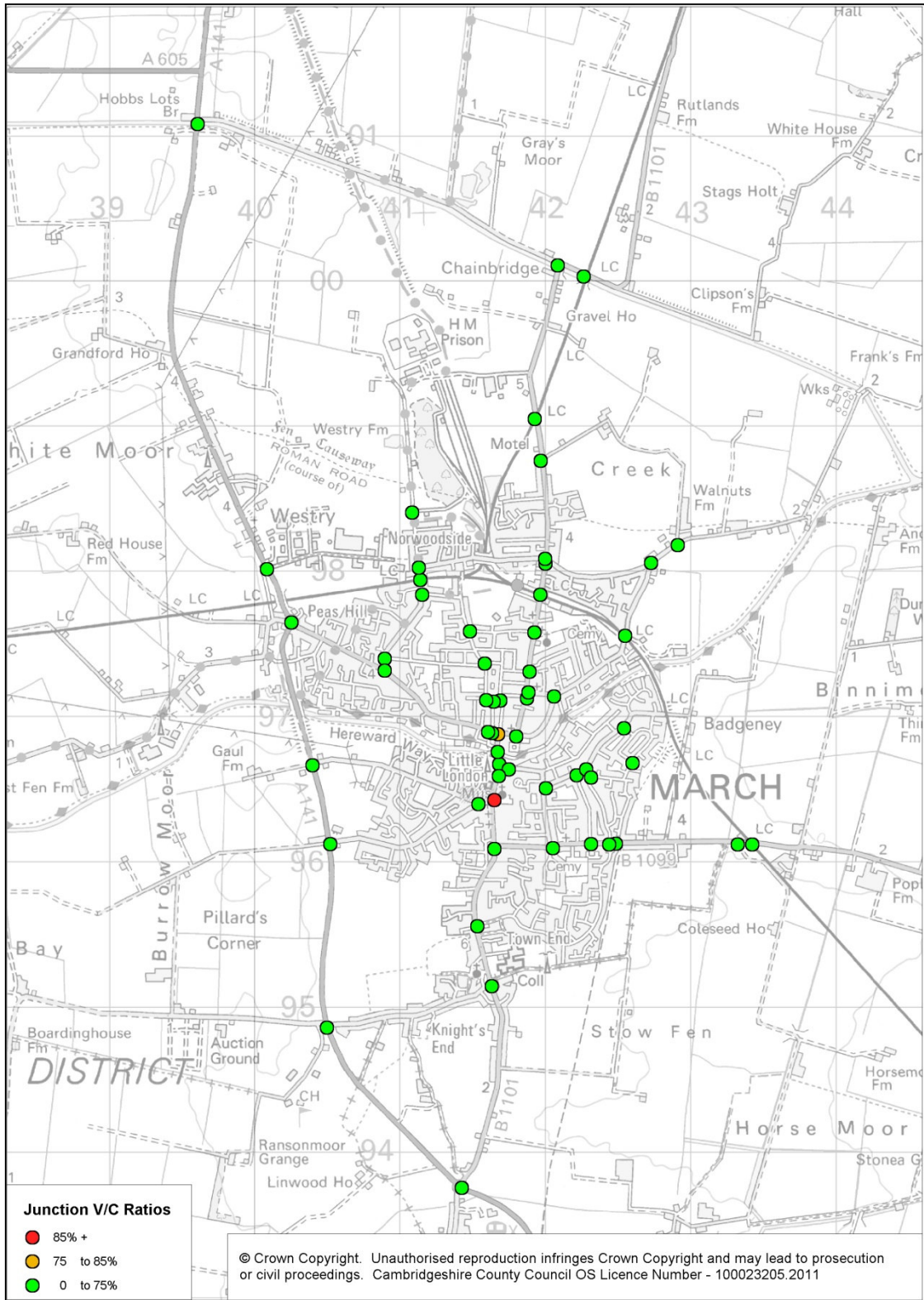

Figure H.28 – Junction V/C (2026 DM, IP)

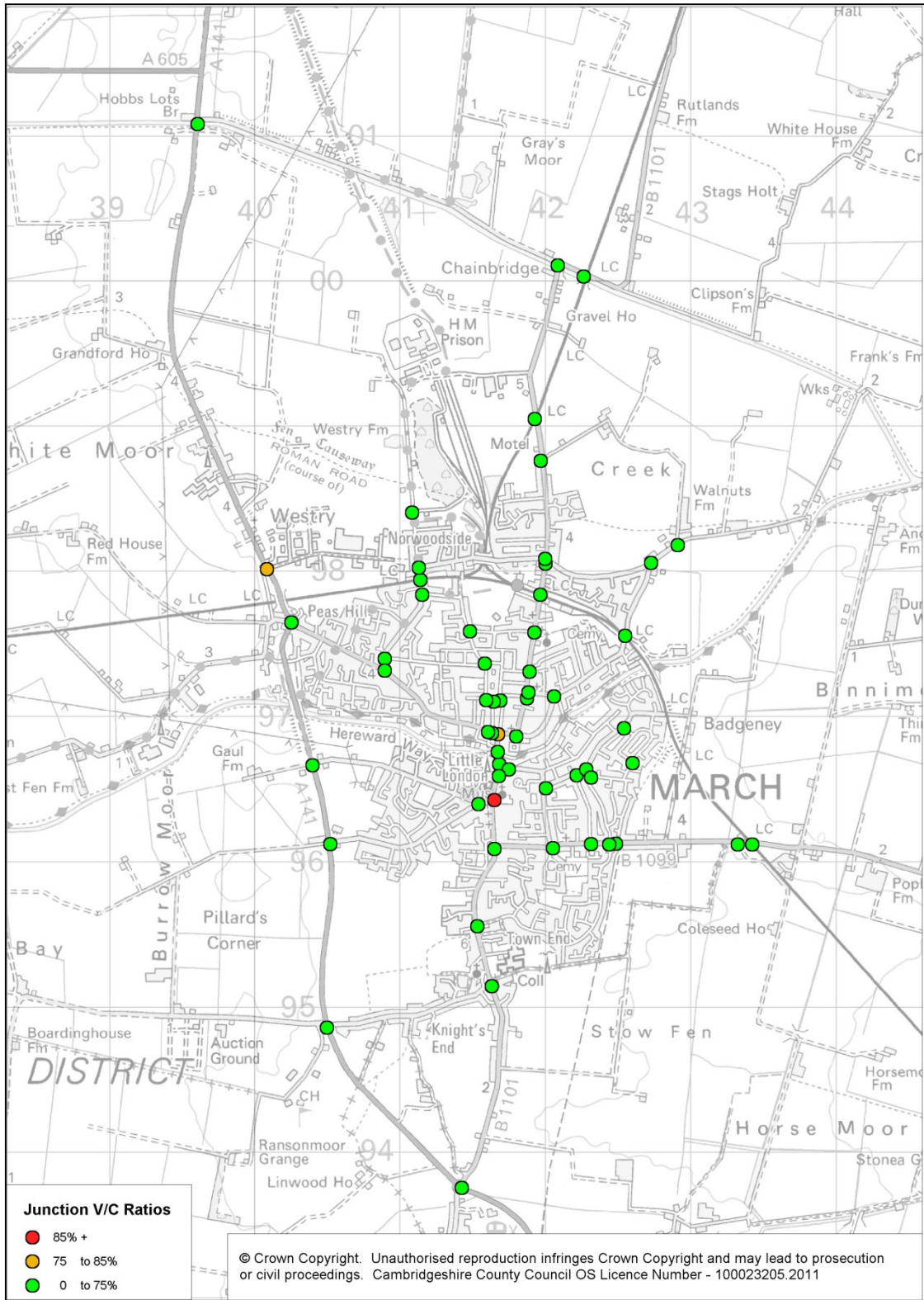

Figure H.29 – Junction V/C (2026 DS1, IP)

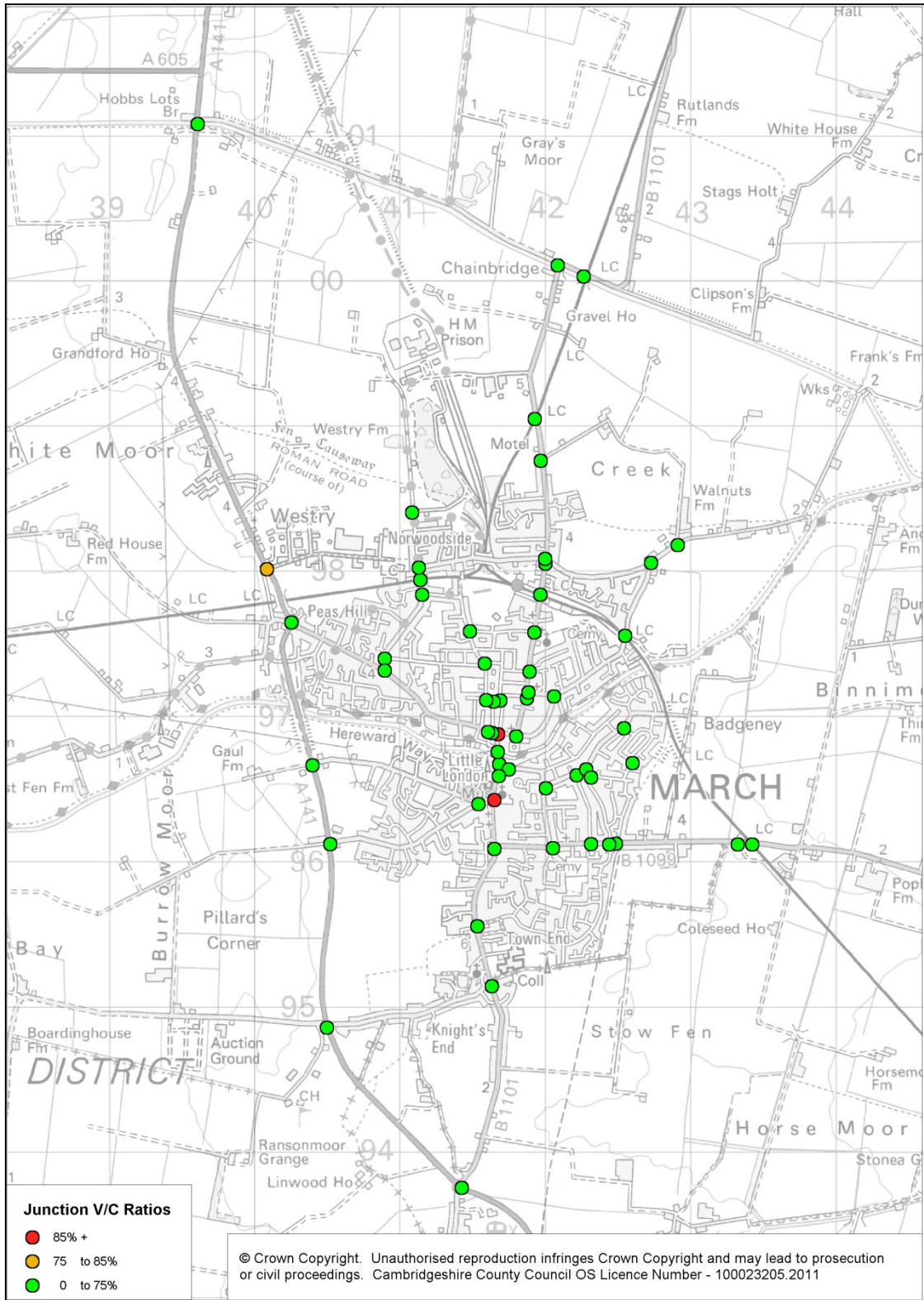

Figure H.30 – Junction V/C (2026 DS2, IP)

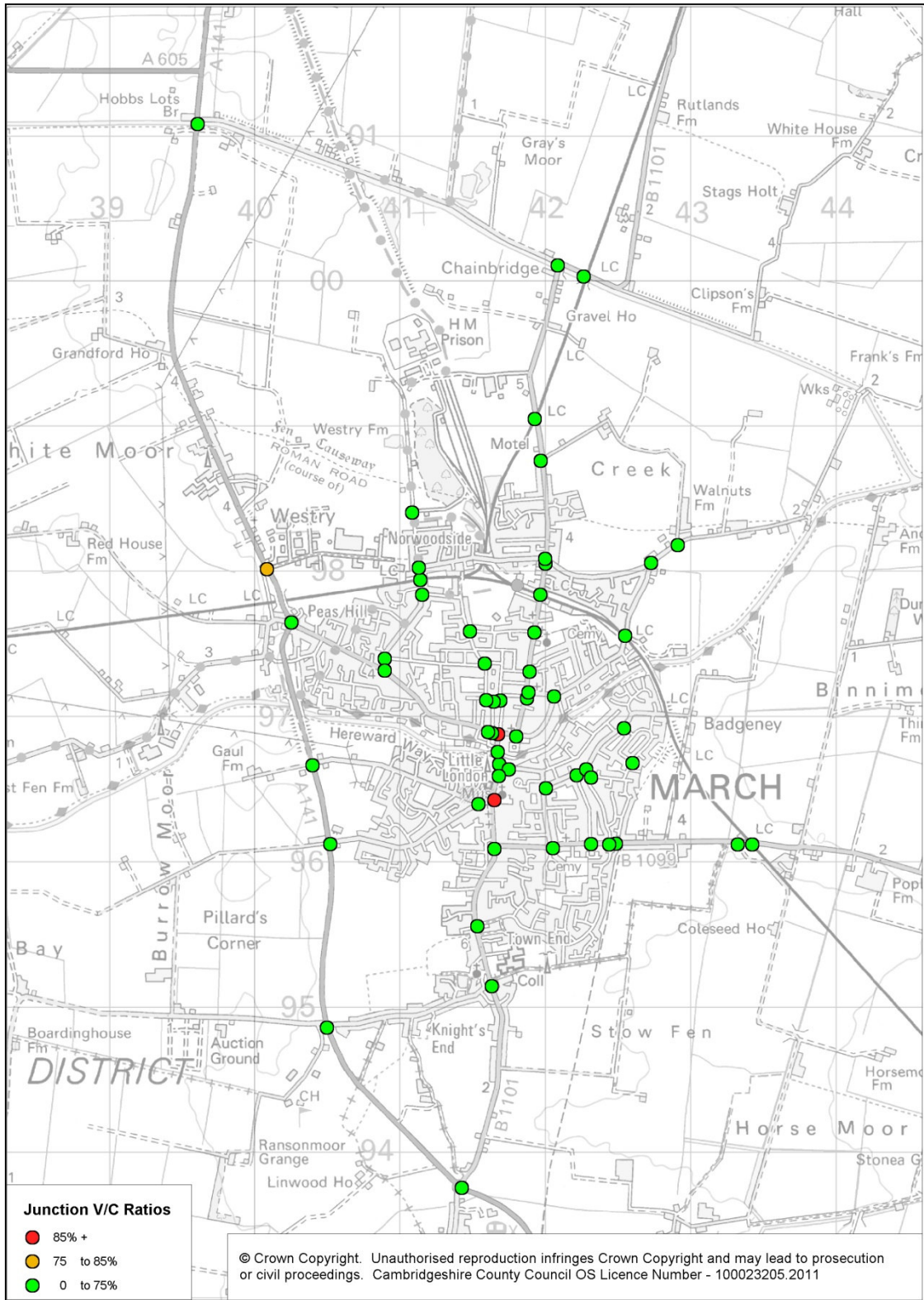

Figure H.31 – Junction V/C (2010 Base, PM)

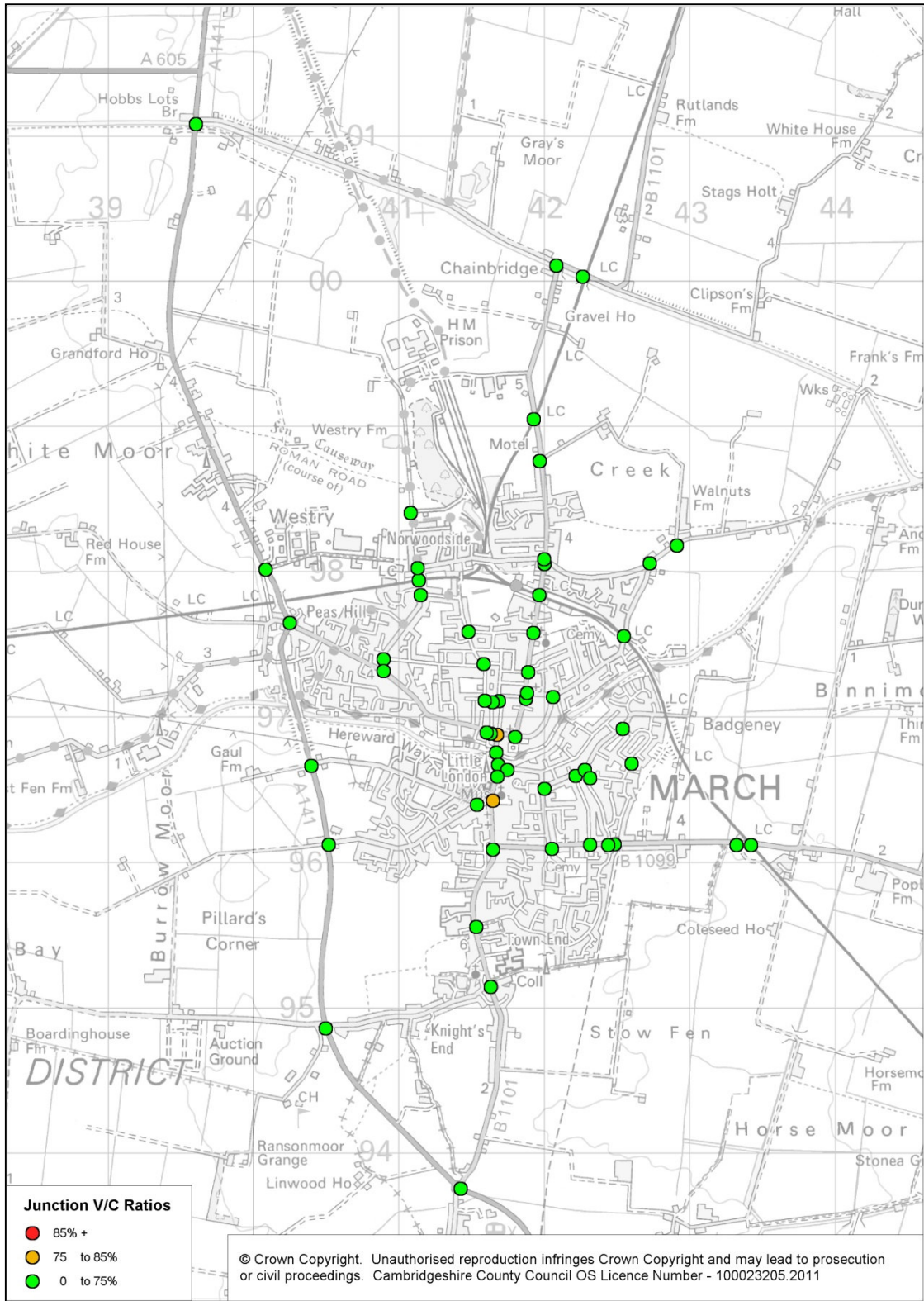

Figure H.32 – Junction V/C (2016 DM, PM)

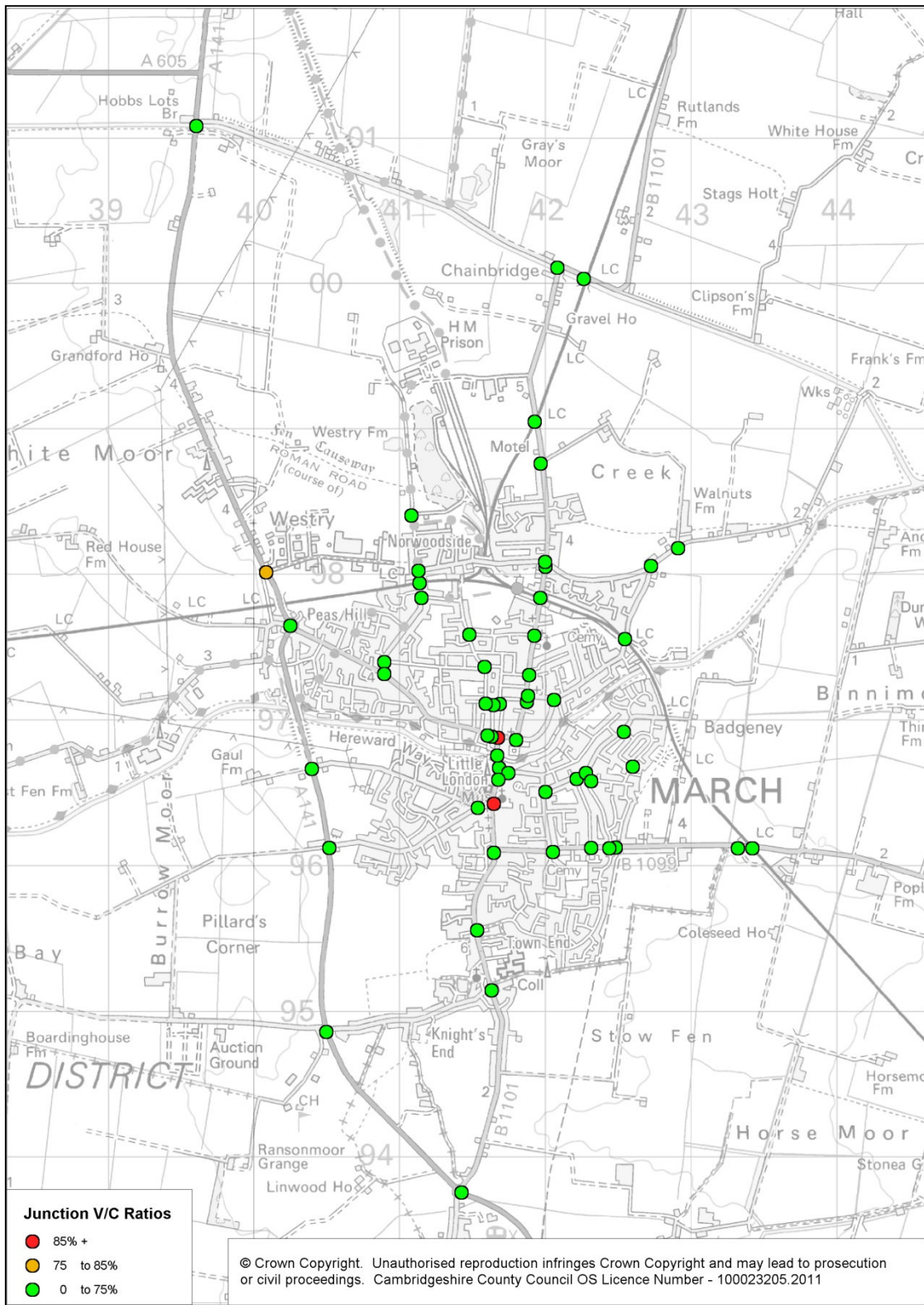

Figure H.33 – Junction V/C (2016 DS1, PM)

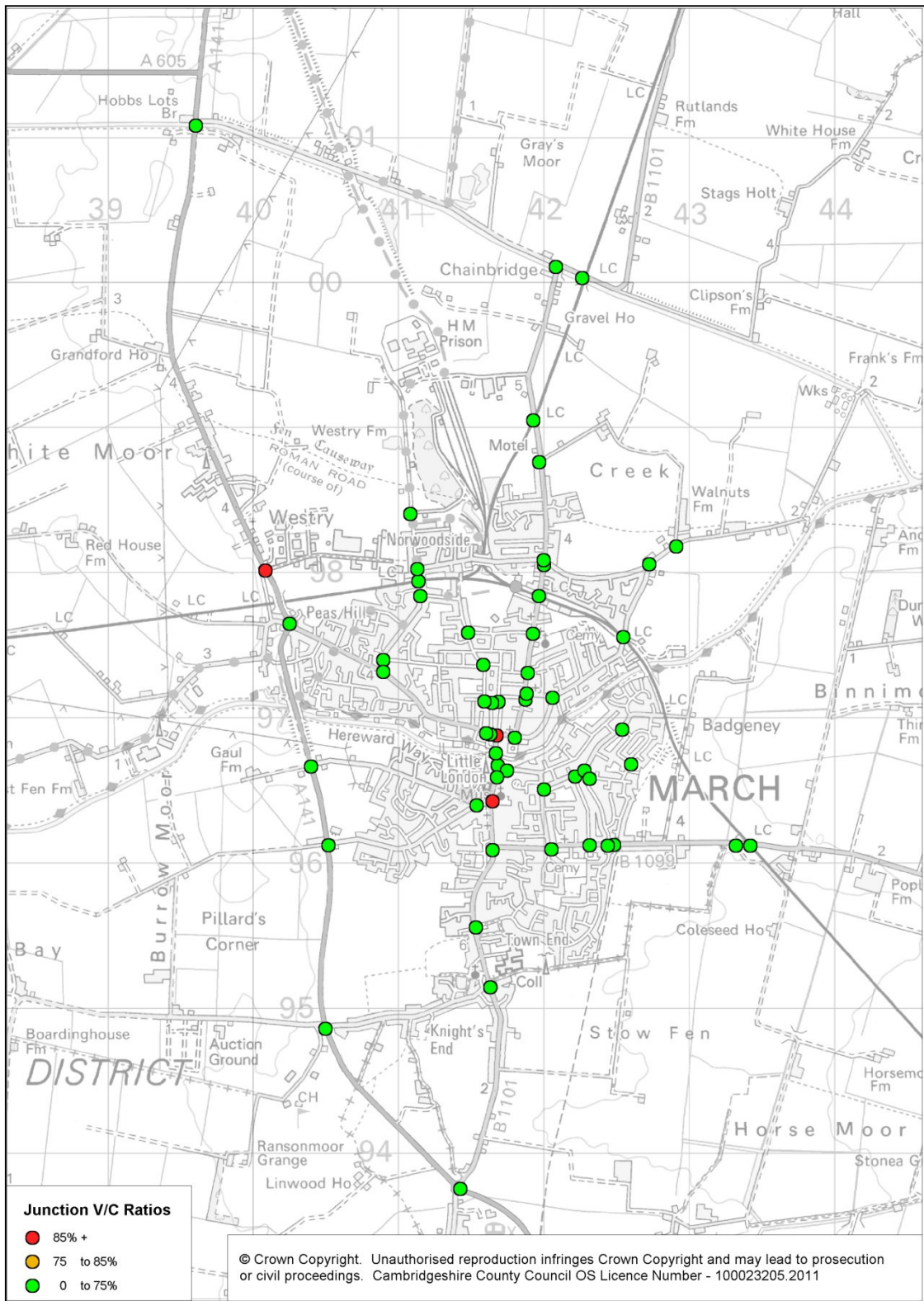

Figure H.34 – Junction V/C (2021 DM, PM)

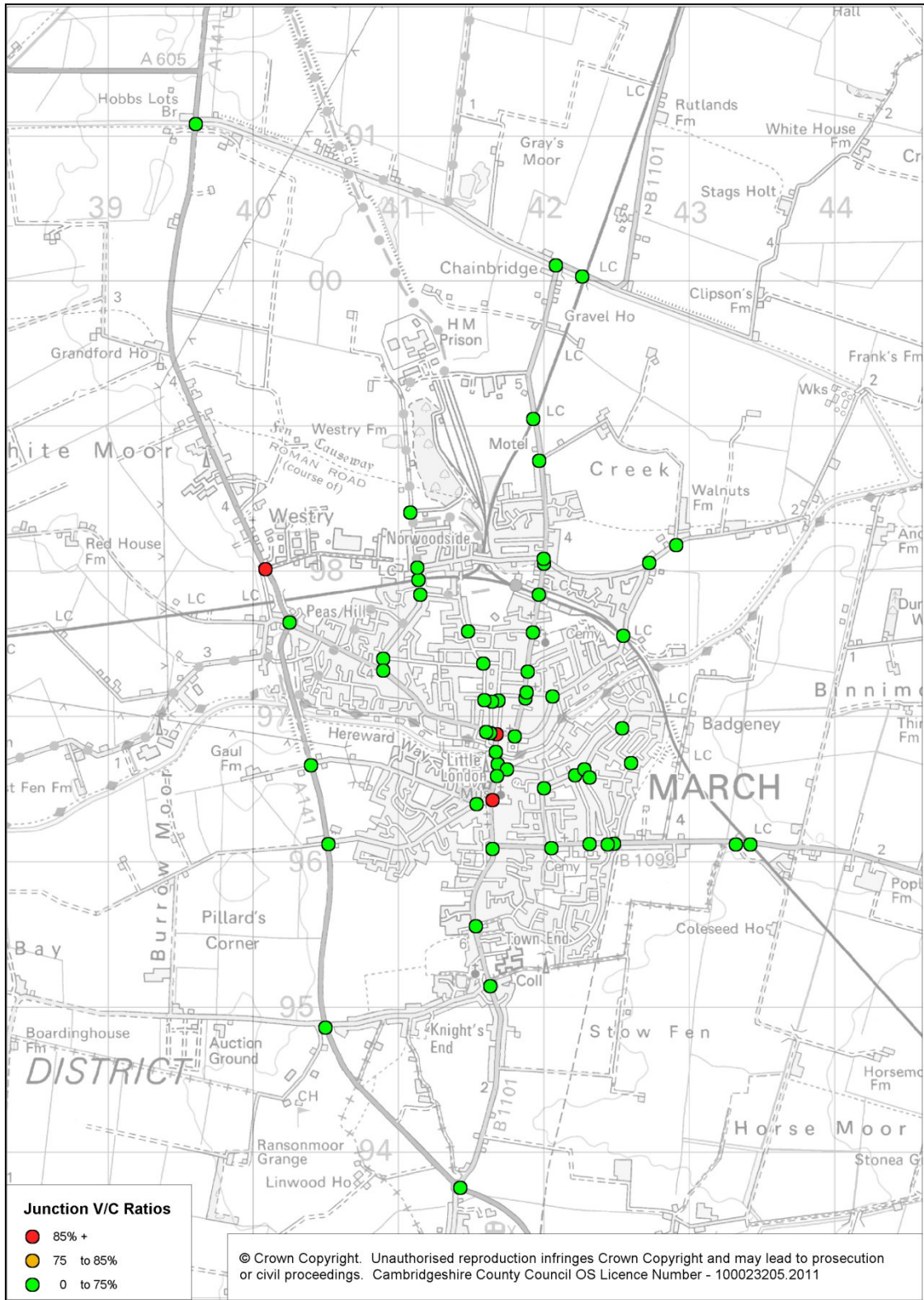

Figure H.35 – Junction V/C (2021 DS1, PM)

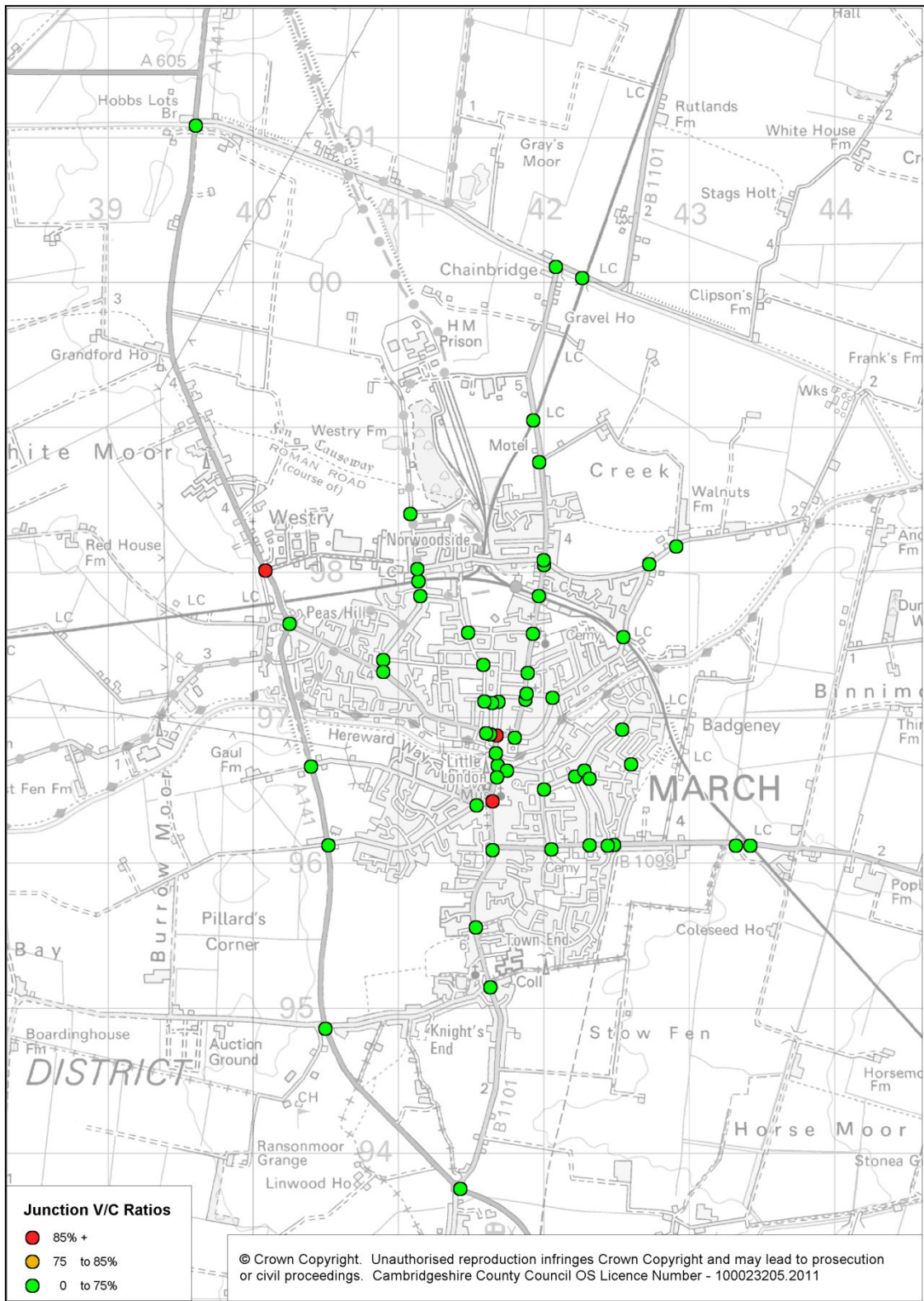

Figure H.36 – Junction V/C (2021 DS2, PM)

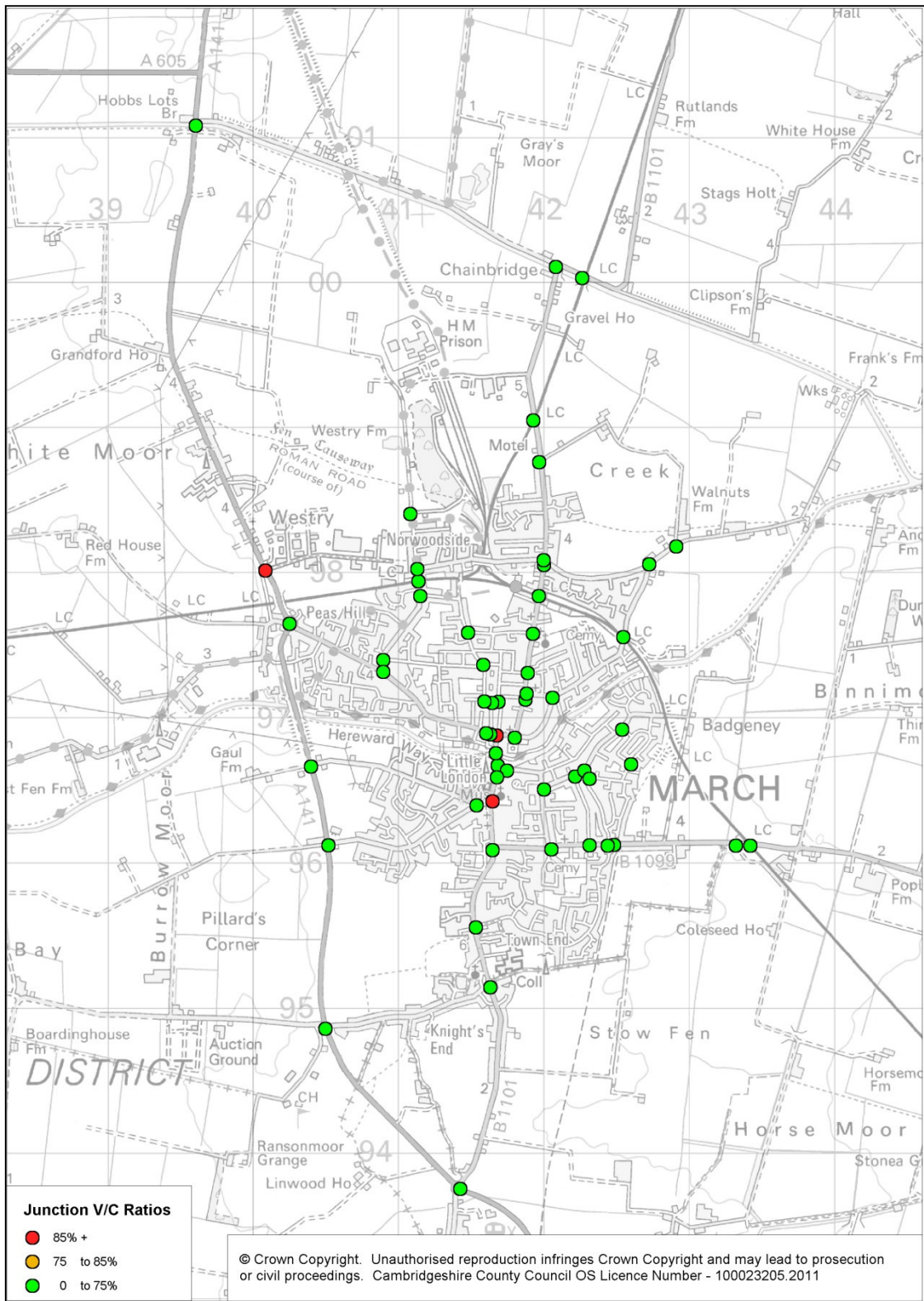

Figure H.37 – Junction V/C (2026 DM, PM)

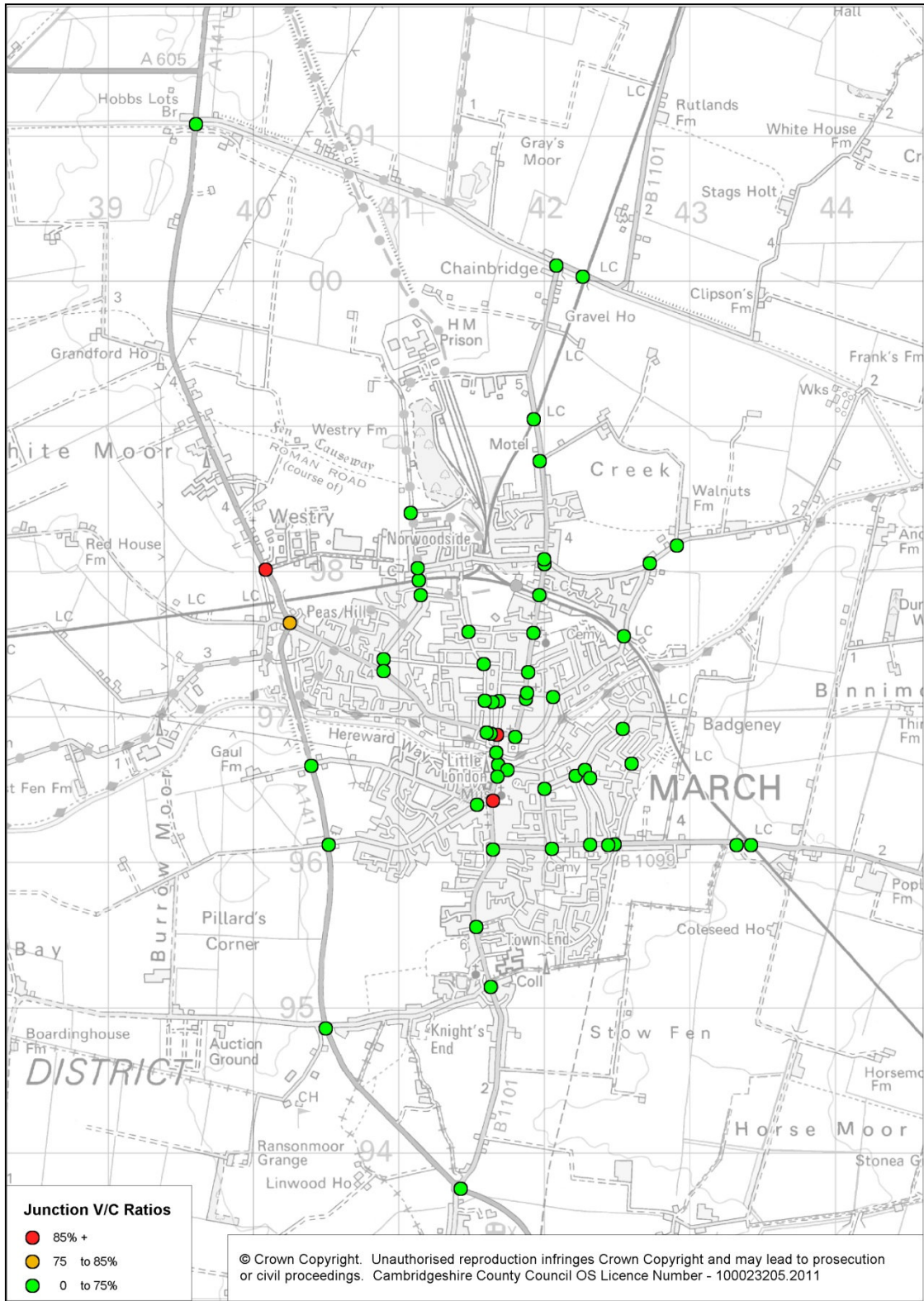

Figure H.38 – Junction V/C (2026 DS1, PM)

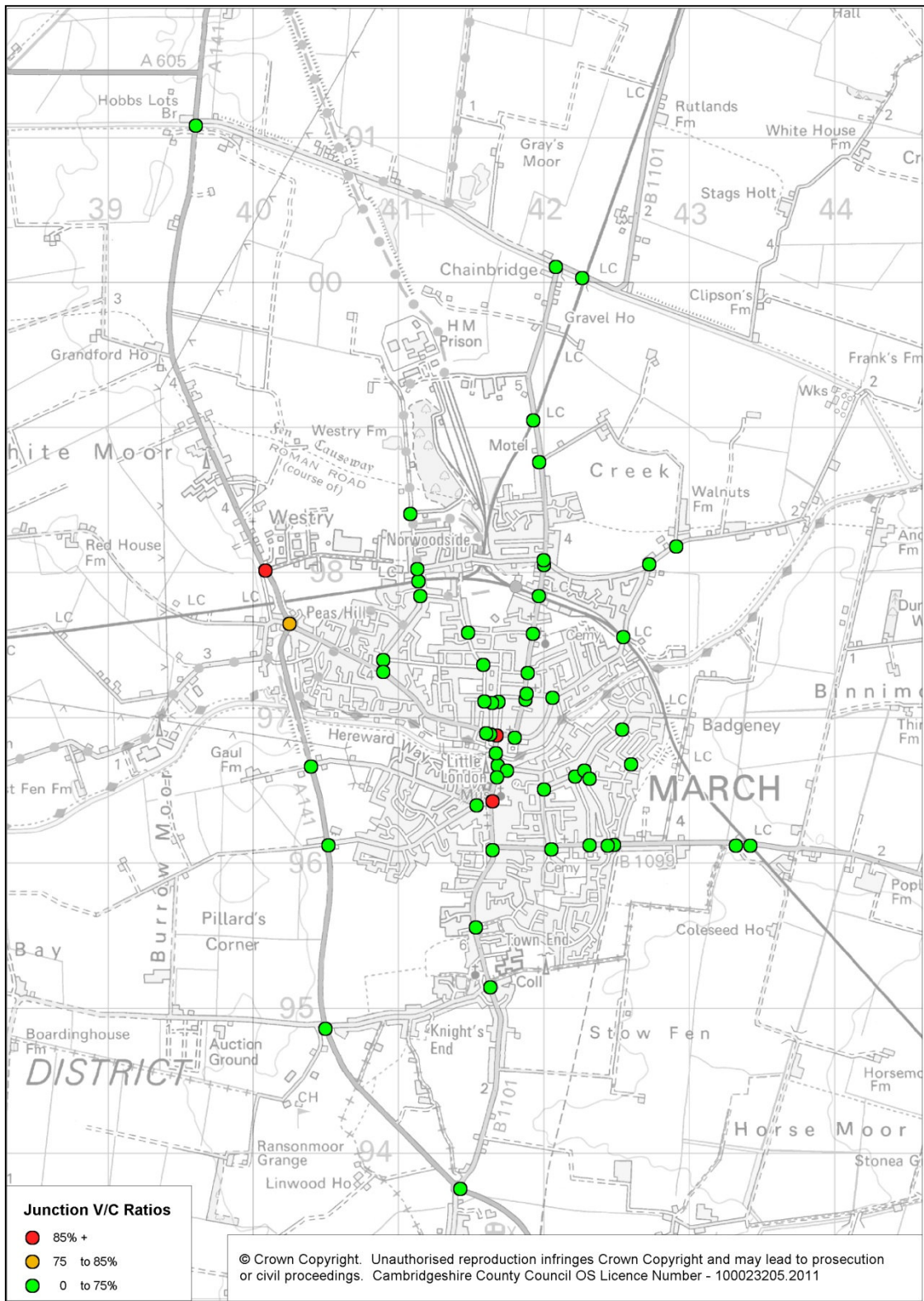
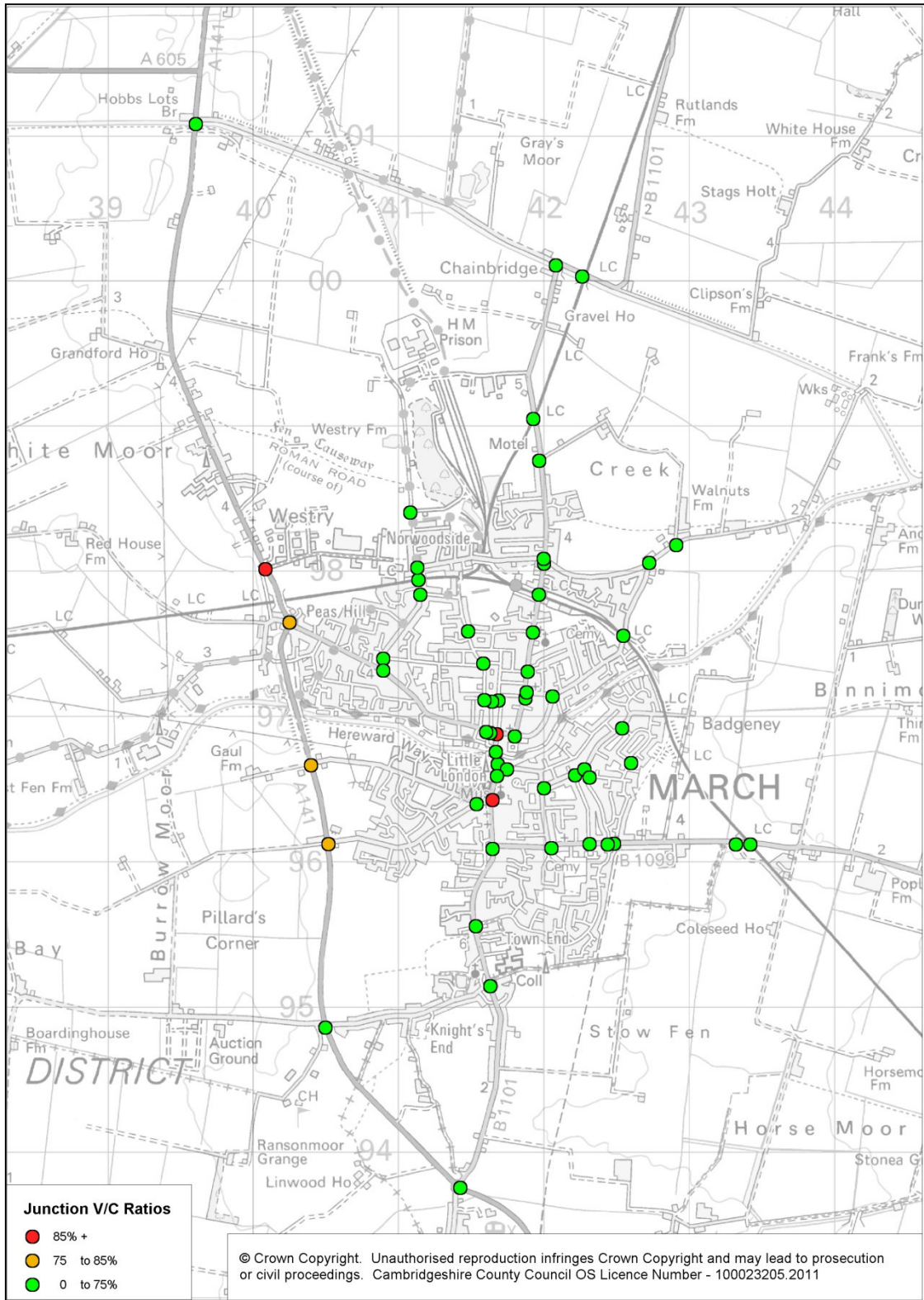

Figure H.39 – Junction V/C (2026 DS2, PM)



I. Forecasting Methodology Note



Project: March Area Transport Study	To: CCC/FDC
Subject: Development of Future Year Matrices & Tests	From: Paul Eagle
Date: 21 April 2011	cc: Sam Appleton/Kit Tang

1. Introduction

This note provides a summary of the proposed method of developing the future year highway matrices for the March Area Transport Study.

The forecast years to be modelled are 2016, 2021 and 2026, these are consistent with Fenland District Council’s Local Development Framework. Although the recent ‘Shaping Fenlands Future’, Stage 2 report looks at growth from 2011 to 2031.

This note is intended to provide an outline of the level of growth to be applied to the forecast Do-Minimum and Do-Something forecast scenario’s, including tests of varying levels of growth, based on the information provided in the following documents:

- 2010 Strategic Housing Land Accessibility Assessment (SHLAA);
- 2007 Employment land review: and
- ‘Shaping Fenlands Future’ stage 2 report.

Details associated with overall growth factors for Cambridgeshire, Fenland and March from TEMPRO 6.1 are provided in section 2.

From the information available to date it is recommended that the following tests are undertaken as an initial assessment of the impacts of Local Development framework for March:

- Do – Minimum scenario’s for 2016, 2021 and 2026, to include all committed developments and background growth, controlled to TEMPRO 6.1 growth projections (DM);
- Do – Something scenario’s for 2016, 2021 and 2026, to include the DM above, + SFF Option 1 controlled to TEMPRO (DS1); and
- Do –Something scenario’s for 2016, 2021 and 2026, to include DS1, + the difference between SFF option 2 and option 1, to form a TEMPRO 6.1+ test (DS2), the SFF preferred option.

The growth figures to be used in the above scenario’s are set out in Table 3.3, Projected growth figures.

2. Growth Factors

The principle source of traffic growth for light vehicles is TEMPRO 6.1. The growth factors for car driver trips are presented in Tables 2.1 to 2.4. for the period 2010 to 2016, 2021, 2026 and 2031.

Table 2.1 – TEMPRO 6.1 Factors from 2010 to 2016

Area	Time Period	Car Driver Trip End Growth	Fuel and Income Factor	Composite Factor
Cambridgeshire	AM	1.090	1.070	1.166
	Inter Peak	1.092	1.070	1.169
	PM	1.091	1.070	1.167
Fenland	AM	1.075	1.070	1.150
	Inter Peak	1.084	1.070	1.160
	PM	1.078	1.070	1.154
March	AM	1.083	1.070	1.159
	Inter Peak	1.094	1.070	1.171
	PM	1.087	1.070	1.163

Note: 1. The trip end growth is the average of origin and destination growth.

Table 2.2 – TEMPRO 6.1 Factors from 2010 to 2021

Area	Time Period	Car Driver Trip End Growth	Fuel and Income Factor	Composite Factor
Cambridgeshire	AM	1.147	1.100	1.262
	Inter Peak	1.162	1.100	1.278
	PM	1.150	1.100	1.265
Fenland	AM	1.121	1.100	1.234
	Inter Peak	1.153	1.100	1.268
	PM	1.129	1.100	1.242
March	AM	1.136	1.100	1.249
	Inter Peak	1.170	1.100	1.287
	PM	1.144	1.100	1.259

Note: 1. The trip end growth is the average of origin and destination growth.

Table 2.3 – TEMPRO 6.1 Factors from 2010 to 2026

Area	Time Period	Car Driver Trip End Growth	Fuel and Income Factor	Composite Factor
Cambridgeshire	AM	1.212	1.126	1.364
	Inter Peak	1.246	1.126	1.403
	PM	1.218	1.126	1.371
Fenland	AM	1.176	1.126	1.324
	Inter Peak	1.236	1.126	1.392
	PM	1.190	1.126	1.340
March	AM	1.197	1.126	1.348
	Inter Peak	1.261	1.126	1.420
	PM	1.212	1.126	1.364

Note: 1. The trip end growth is the average of origin and destination growth.

Table 2.4 – TEMPRO 6.1 Factors from 2010 to 2031

Area	Time Period	Car Driver Trip End Growth	Fuel and Income Factor	Composite Factor
Cambridgeshire	AM	1.267	1.144	1.449
	Inter Peak	1.318	1.144	1.508
	PM	1.276	1.144	1.460
Fenland	AM	1.220	1.144	1.396
	Inter Peak	1.309	1.144	1.498
	PM	1.241	1.144	1.420
March	AM	1.248	1.144	1.428
	Inter Peak	1.342	1.144	1.535
	PM	1.269	1.144	1.452

Note: 1. The trip end growth is the average of origin and destination growth.

2.1 Heavy Goods Vehicles

2.1.1 Assumptions

The following section addresses growth as applied to Heavy Goods Vehicles (HGV), which are user classes (UC) five and six in the demand matrices/model.

Relating these user classes to the definitions within NRTF UC6 is the class defined in NRTF as ‘articulated HGV’s’ (or OGV2) while UC5 approximates to ‘rigid HGV’s’ (or OGV1).

2.1.2 Growth Factors

The growth factors for HGV’s are based on the growth indices from 2009 which are derived from the May 2010 NRTF 2009 update.

3. Do-Minimum Growth scenario

3.1.1 Derived Residential DM growth

The DM forecast demand matrices for future year model runs of 2016, 2021 and 2026, will consist of background growth and committed developments and will be controlled to TEMPRO 6.1 growth predictions, as defined by the following:

- 2010 Strategic Housing Land Accessibility Assessment (SHLAA);
- 2007 Employment land review; and
- TEMPRO 6.1

The 2010 base year demand matrices will be growthed by time period to represent the TEMPRO 6.1 growth factors as set out in section 2, to get to future year scenario's for 2016, 2021 and 2026.

Where known SHLAA (residential) and employment sites have been identified these will be represented in their correct geographical location, with the remainder of the growth being distributed amongst the remaining zones to bring each future year demand matrices to the projected TEMPRO 6.1 growth.

It is assumed that all committed developments will be completed within the next 5 years and will therefore be included in all future year DM scenario's.

3.1.2 Residential

The Allocation of committed developments have been derived from the three documents above, and have been defined in the 'Shaping Fenlands Future' stage 2 report from 'Table x:SFF spatial growth options for testing', page 68, and are replicated here in Table 3.1 for convenience.

Table 3.1 – SFF Residential growth figures

March and Cluster	
Extant	491
Urban Capacity Sites	97
Extra Urban Capacity sites	199
Windfall	379
Affordable exceptions	29
Urban Sub-total	1194

3.1.3 Employment to be defined for DM scenario.

The level of employment defined in the 2007 review is expressed in hectares, and so does not directly correlate with the jobs in the SFF report. For the DM all committed employment development sites will be included, for March this equates to 2.98 hectares.

3.2 Do-Something Growth scenario

3.2.1 Derived Residential DS growth

The DS growth scenario's will use the DM scenario above as its starting point. The SFF stage 2 report defines three options of growth for opportunity zones (LDF), and has recommended that option 2 be the preferred option.

The opportunity zones for residential developments have been presented as follows for each of the options:

Option 1 - 2200; and

Option 2 – 4250.

The overall total to be included in the preferred option 2 is 4250, this includes the 2200 from option 1.

These values are to 2031 and have therefore been adjusted to reflect that we are only modelling to 2026. The adjusted values have been derived from the profiles on page 78 of the SFF report and are presented in Table 3.2 and 3.3 below.

The Fenland District Council “Core Strategy and Development Policies - Preferred Option 2” report from 2007 indicates that residential provision for March by 2024 will be 1800 dwellings, taken from “Table 2 New Land Requirement”, page 25.

The SFF residential forecasts to 2026 is for 1750 dwellings, therefore to bring the residential allocation in line with the “Preferred options 2” housing figures the number of dwellings in the period 2009 to 2024 has been increased from 1750 to 1800.

Table 3.2 – SFF Residential growth figures 2009 to 2026

Year	Option 1	Option 2	Option 1 %	Option 2 %
2009-2010	0	0		
2010-2011	0	0		
2011-2012	0	0		
2012-2013	100	100		
2013-2014	150	150		
2014-2015	175	175		
2015-2016	175	175		
Sub-total	600	600	27	14
2016-2017	175	175		
2017-2018	200	200		
2018-2019	200	200		
2019-2020	150	175		
2020-2021	150	175		
Sub-total	875	925	40	22
2021-2022	125	225		
2022-2023	100	225		
2023-2024	100	275		
2024-2025	75	250		
2025-2026	50	250		
Sub-total	450	1225	18	29
Total 2009-2026	1925	2750	85	65

*Figures to be confirmed from SSF raw data.

Table 3.3 – SFF Residential growth figures 2026 to 2031

Year	Option 1	Option 2	Option 1%	Option 2%
2026-2027	75	325		
2027-2028	75	350		
2028-2029	75	325		
2029-2030	50	300		
2030-2031	50	200		
Sub-total	325	1500	15	35
Total	2200	4250	100	100

*Figures to be confirmed from SSF raw data.

These will be located within the opportunity zones 'Z1' and 'Z2' identified in the SFF stage 2 report, see Figure 1.

3.2.2 Employment to be defined for DS scenario.

The DS growth scenario's will use the DM scenario above as its starting point. The SFF stage 2 report defines three options of growth for employment (LDF), and has recommended that option 2 be the preferred option.

Employment jobs for March have been presented as follows for each of the options:

Option 1 - 970; and

Option 2 – 2811.

The overall total to be included in the preferred option 2 for March is 2811, this includes the 970 from option 1. The SFF concludes a take up rate of 5.6 hectares per annum from 2011, which equates approximately to 90 hectares from 2011 to 2026, across Fenland. The 2007 employment review report projects 86 hectares of employment to 2024 across Fenland.

It is therefore suggested that the level of employment to be modelled at 2026 is based on the information within the 2007 Employment land review and that for the DS these will include the 2.98 hectares of committed development from the DM for March, plus 28.62 hectares of allocated employment for March (see table 3.5). These will be located within the opportunity zones 'Z1' and 'Z2' identified in the SFF stage 2 report, see Figure 1.

These values have been taken from table 19 of the 2007 employment review report. The remainder of the employment to be distributed across the Fenland zones.

3.2.3 Future year DM forecasts and TEMPRO.

The DM future year assignments will be controlled to TEMPRO 6.1, but as mentioned above all known committed developments will be presented in their correct geographical locations, where known.

3.2.4 Future year DS forecasts and TEMPRO.

The residential and employment growth figures presented in the SFF report for option 1 are similar to the projected TEMPRO 6.1 figures (this needs to be confirmed for employment). Therefore it is intended that the demand matrices for the future year test option 2 growth figures for the DS test will be TEMPRO 6.1 +, where the demand matrices will be controlled to TEMPRO 6.1, using option 1 growth figures, but the difference between option 2 and option 1 will be applied on top of the TEMPRO 6.1 controlled total.

Table 3.4 below summarises the DM and DS committed and allocated residential and employment figures to be used in the forecast SATURN assignments.

Table 3.4 – Projected growth figures

Year	Scenario	Committed		SFF Option 1		SFF Option 2		SFF Option 2 (TEMPRO +)	
		Res.	Emp.(ha)	Res.	Emp.(ha)	Res.	Emp(ha)	Res.	Emp(ha)
2016	DM	1194	2.98						
	DS	1194	2.98	600	10.7	600	10.7	1794	13.68
2021	DM	1194	2.98						
	DS	1194	2.98	1475	19.6	1525	19.6	2719	22.58
2026	DM	1194	2.98						
	DS	1194	2.98	1925	28.6	2750	28.6	3944	31.58

Table 3.5 below has been taken from the 2007 Employment land review report (Table 19) and set out the projected employment growth in hectares for Fenland District. The employment growth figures in table 3.3 above are derived from this table.

Table 3.5 – 2007 Employment Land review growth projections

District	Allocated dev (ha)	Committed Dev(ha)	Total(ha)
Chatters	9.04	0.28	9.32
March	28.62	2.98	31.6
Whittlesey	0.59	0	0.59
Wimblington	0.5	0.92	1.42
Wisbech	38.64	1.64	40.28
Doddington	0	1.26	1.26
Manea	0	0.26	0.26
Newton	0	0.57	0.57
Tydd St. Mary	0	0.92	0.92
Total	77.39	8.83	86.22

The SFF stage 2 report, as concluded an annual employment land rate of 5.6 hectares, from 2011 to 2031, this equates to the following hectares for each of the March Area Transport Study future assignment years:

- 2016 - 33.6 (ha);
- 2021 – 61.6 (ha); and
- 2026 – 89.6 (ha).

The SFF report takes growth to 2031 and on the basis of the 5.6 hectares per annum this projects a total of 113 hectares to 2031, the short fall between the 86 hectares in the 2007 employment land review report of 27 hectares has been distributed across the fenland districts for each of the options and is set out in Table 3.6 below.

Table 3.6 – SFF additional floorspace across district to 2031

District	SFF Option 1	SFF Option 2	SSF Option 3
Wisbech	14.4	8.3	13.3
March	17.5	16.3	10.5
Whittlesey	-5.2	0.6	1.1
Chatteris	0.5	2.0	2.4
Total	27.2	27.2	27.3

Figure 1 SFF March Opportunity Zones

SHAPING FENLAND'S FUTURE - GROWTH OPTIONS

March - OPPORTUNITY ZONE(S) ANALYSIS

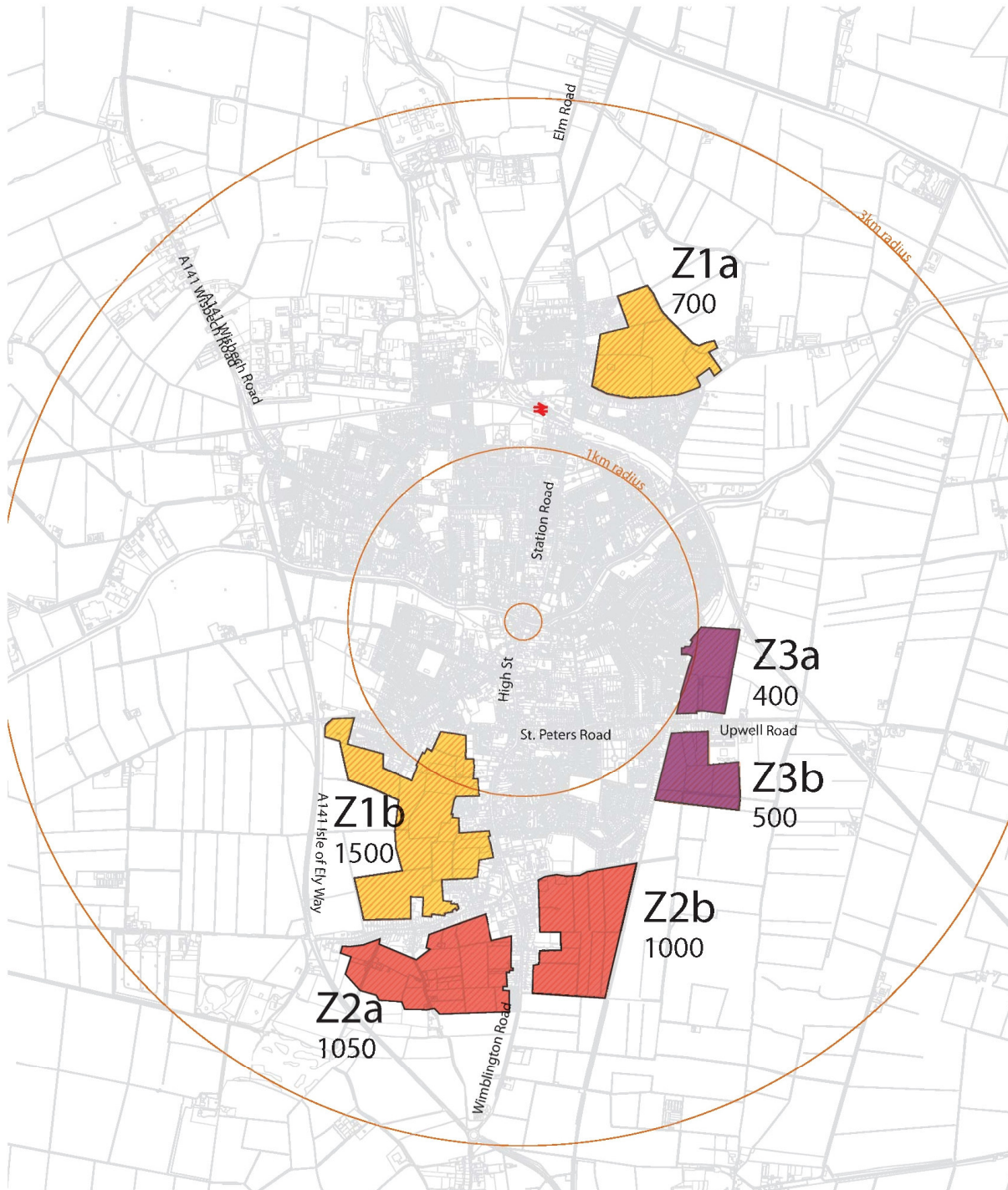

- Zone 1 – Opportunity zone with limited constraints / risks
- Zone 2 – Zones with more risks / constraints, but potentially more opportunity
- Zone 3 – High opportunity zones but highly constrained



Paul Eagle
2 Wellbrook Court
Girton Road
Cambridge
CB3 0NA
Email: paul.eagle@atkinsglobal.com
Telephone: +44 (0) 1223 814400
Direct telephone: +44 (0) 1223 814030
Fax: +44 (0) 1223 814520

© Atkins Ltd except where stated otherwise.

The Atkins logo, 'Carbon Critical Design' and the strapline
'Plan Design Enable' are trademarks of Atkins Ltd.